



BEST OF AUTO | 2025

LIGHT AND HEAVY VEHICLES, CONSTRUCTION EQUIPMENT



BAHCO

BEST OF AUTO 2025



TOOL KITS

3



UNDER CAR

111



LIFTING EQUIPMENT

43



AIR TOOLS

125



WORKSHOP EQUIPMENT 55



IMPACT SOCKETS

137



STORAGE

61



SOCKET SETS

145



TOOLS FOR ENGINE

77



TORQUE TOOLS

165



TOOLS FOR BATTERIES

89



CAR BODY

173

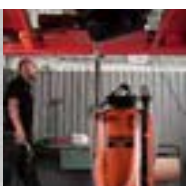

OIL & FILTERS

101



OTHER TOOLS

187





TOOL KITS



1472K7BKFFM**Tool trolley auto repair toolkit - 243 pcs****MODULE 5 - SOCKETRY AND ACCESSORIES**

A6700DM-10	SOCKET 1/4"
A6700DM-11	SOCKET 1/4"
A6700DM-12	SOCKET 1/4"
A6700DM-13	SOCKET 1/4"
A6700DM-14	SOCKET 1/4"
A6700DM-5	1/4 BI-HEX SOCKET 5 MM
A6700DM-5.5	SOCKET 1/4"
A6700DM-6	SOCKET 1/4"
A6700DM-7	SOCKET 1/4"
A6700DM-8	SOCKET 1/4"
A6700DM-9	SOCKET 1/4"
A6800DM-10	SOCKET 1/4"
A6800DM-11	SOCKET 1/4"
A6800DM-13	SOCKET 1/4"
A6800DM-7	SOCKET 1/4"
A6800DM-8	SOCKET 1/4"
A6800DM-9	SOCKET 1/4"
7800DM-10	SOCKET 1/2
7800DM-11	SOCKET 1/2
7800DM-12	SOCKET 1/2
7800DM-13	SOCKET 1/2
7800DM-14	SOCKET 1/2
7800DM-15	SOCKET 1/2
7800DM-16	SOCKET 1/2
7800DM-17	SOCKET 1/2
7800DM-18	SOCKET 1/2
7800DM-19	SOCKET 1/2
7800DM-20	SOCKET 1/2
7800DM-21	SOCKET 1/2
7800DM-24	SOCKET 1/2
7800DM-27	SOCKET 1/2
7800DM-30	SOCKET 1/2
7800DM-32	SOCKET 1/2
7800DM-34	SOCKET 1/2
7805DM-10	SOCKET 1/2
7805DM-13	SOCKET 1/2
7805DM-16	SOCKET 1/2
7805DM-17	SOCKET 1/2
7805DM-18	SOCKET 1/2
7805DM-19	SOCKET 1/2
7805SM-16	SOCKET DEEP 1/2"
7805SM-21	SOCKET DEEP 1/2"
7809TORX-T30	SOCKET 1/2
7809TORX-T40	SOCKET 1/2
7809TORX-T45	SOCKET 1/2
7809TORX-T50	SOCKET 1/2
7809TORX-T50120	1/2 SOCKET DRIVER TORX50 L120
7809TORX-T55	SOCKET 1/2
7809TORX-T55120	1/2 SOCKET DRIVER TORX55 L120
7809TORX-T60	SOCKET 1/2
7809TORXT40-120	TORX BIT SOCKET 1/2-T40 L
7809TORXT45-120	TORX BIT SOCKET 1/2-T45 L
7809XZN-12-100	SOCKET DRIVER 1/2
8150RN-1/2	RATCHET 1/2,ROUND TYPE
8157-15	BREAKERBAR 1/2 15IN METAL HNDL
8160-10	EXTENSION 1/2 250MM 10IN
8160-5	EXTENSION 1/2 125MM 5IN
8166	UNIVERSAL JOINT 1/2
8174A	BITHOLDER 1/2" SQ TO 5/16" HEX
6950CBR	8MM COMBINATION BITRATCHET 1/4
6950RN	RATCHET 1/4,ROUND TYPE
6956	SPINNER HANDLE 1/4
6960-4	1/4" EXTENSION BAR 100MM - 4
6966	1/4 UNIVERSAL JOINT
6973A	BIT HOLDER 1/4 SQ TO 1/4 HEX
70S/T45	5XBITS TORX T45 35 MM 5/16
70S/T50	5XBITS TORX T50 35 MM 5/16
70S/T55	5XBITS TORX T55 35 MM 5/16

MODULE 6 - IMPACT SOCKETS

K7801M-10	POWER SOCKET 1/2
K7801M-11	POWER SOCKET 1/2
K7801M-12	POWER SOCKET 1/2
K7801M-13	POWER SOCKET 1/2
K7801M-14	POWER SOCKET 1/2
K7801M-15	POWER SOCKET 1/2
K7801M-16	POWER SOCKET 1/2
K7801M-17	POWER SOCKET 1/2
K7801M-18	POWER SOCKET 1/2
K7801M-19	POWER SOCKET 1/2
K7801M-21	POWER SOCKET 1/2
K7801M-22	POWER SOCKET 1/2
K7801M-23	POWER SOCKET 1/2
K7801M-24	POWER SOCKET 1/2
K7801M-27	POWER SOCKET 1/2
K7801M-30	POWER SOCKET 1/2
K7801M-32	POWER SOCKET 1/2
K8160D-1	POWER SOCKET EXTENSION 1/2
K8167S	POWER SOCKET UNIVERS. JOINT 1/2
BPC813	1/2"IMPACT WRENCH MICRO
BWSMB15	1/2"-15MM WHEEL SOCKET_IMP
BWSMB17	1/2"-17MM MB ANTI-THEFT SOCKET
BWSS12P317	1/2IN-17MM WHEEL IMP SOCKET
BWSS12P319	1/2IN-19MM WHEEL IMP SOCKET
BWSS12P321	1/2IN-21MM WHEEL IMP SOCKET
BWSS12P522	1/2IN-22MM WHEEL IMP SOCKET
BWSS12P524	1/2IN-24MM WHEEL IMP SOCKET
BWTSP6	1/2"- 6PCS TWIST SOCKET SET
7994S0300	1/2" IMPACT DRIVER TORX T-30
7994S0400	1/2" IMPACT DRIVER TORX T-40
7994S0450	1/2" IMPACT DRIVER TORX T-45
7994S0500	1/2" IMPACT DRIVER TORX T-50
7994S0550	1/2" IMPACT DRIVER TORX T-55
7994S0600	1/2" IMPACT DRIVER TORX T-60



AUTO

Tool trolley auto repair tool kit - 357 pcs



FF1A222LM - SCREWDRIVERS

BE-7805	NUT DRIVER ERGO
BE-7806	NUT DRIVER ERGO
BE-7807	NUT DRIVER ERGO
BE-7808	NUT DRIVER ERGO
BE-7809	NUT DRIVER ERGO
BE-7810	NUT DRIVER ERGO
BE-7811	NUT DRIVER ERGO
BE-7813	NUT DRIVER ERGO
BE-7855	NUT DRIVER ERGO
D/S14	IMPACT SOCKET SET 1/2 DRIVE
K8160D-1	POWER EXTENSION 1/2 75 MM
K8160D-2	POWER EXTENSION 1/2 125 MM
K8167S	POWER UNIVERSAL JOINT 1/2
BE-8135TB	ERGO THROUGH BLADE,6X3,5X75
BE-8145TB	ERGO THROUGH BLADE 0.8X4,5X100
BE-8150TB	ERGO THROUGH BLADE 1,0X5,5X100
BE-8155TB	ERGO THROUGH BLADE 1,2X6,5X125
BE-8610TB	ERGO THROUGH BLADE PH1X100
BE-8620TB	SB THROUGH BLADE PH2X125
BE-8623TB	ERGO THROUGH BLADE PH3X150
1150-1/2H/P	CALIPER 150MM
59/S31B	31PCS BIT SET RETAIL



FF1A224LM - STRIKING AND CUTTING TOOLS

1435/8	STUD EXTRACTOR SET
319	NYLON FACED HAMMER H/MET 35MM
3625S-35	COTTER PIN PUNCHES SET
3734S/6	CENTRE PUNCH
3735-5-150	FLAT CHISEL
3740-200	SLITTING CHISEL
3750	HAND HACK SANDFLEX, 2-PACK
3906-300-24-2P	BALL PEIN HAMMER
479-16	FIXED UTILITY KNIFE
KBFU-01	HOSE CLAMP SET- 3P
BE256P3	HOSE CLAMP PLIERS SET



FF1A223LM - PLIERS AND HEX KEY WRENCHES

5226 DC	MACHINED GROVE MODELS 16"
158-N	NEEDLE NOSE PLIERS LONG
158-NB	NEEDLE NOSE PLIERS LONG BENT
21HDG-200	ERGO SIDE CUTTER HD 21HDG-200
2430 G-190HD	SNIPER NOSE CUTTING 200
2628G-200IP	COMB PLIER 2628G 200mm
2968-190	GRIP WITH FLAT+CONVEX JAW 190
8224 IP	SLIP JOINT PLIER
BE1P	SPARK PLUG PLIER-290MM-PVC
BE1TH-2.5	T-TYPE HEX KEY WRENCH 2.5MM
BE1TH-3	T-TYPE HEX KEY WRENCH 3MM
BE1TH-4	T-TYPE HEX KEY WRENCH 4MM
BE1TH-5	T-TYPE HEX KEY WRENCH 5MM
BE1TH-6	T-TYPE HEX KEY WRENCH 6MM
BE1TH-8	T-TYPE HEX KEY WRENCH 8MM



FF1A225LM - AUTOMOTIVE ACCESSORIES

2487	CARBON SCRAPER
2535F1	MAGNETIC PICK UP
2633/S4	AWLS AND HOOKS, SET
2485	TRIM PAD REMOVER
782-U	UTILITY WIRE BRUSH
BE5049T	SET OF BITS REGULAR TORX
BE66152	OIL FILTER
2484-45	PRY BAR 450 MM
5515T-52	TELESCOPE MIRROR



1475KXL6CBKFFSD

Campaign trolley with tools – 234 tools

- 6 drawer extra large capacity trolley with cabinet
- Lock & Go! latching system prevents drawers from opening when the trolley is being moved
- Fully opening 30kg capacity drawers equipped with ball-bearing sliders for smooth opening
- Scratchproof powder coating
- Double walled case: if the outside wall is damaged in a collision, the drawers will always open
- Solid steel construction: the double walled case is strengthened with strategically positioned welding points
- Anti-slip rubber worktop
- A solid handle that can be fixed in both side of the trolley
- Strong and secure round locking system protects the trolley against theft
- Noiseless rubber wheels 150x50 mm with 2 brakes ensure maximum stability: 2 fixed and 2 swivel with brake
- Available in different colours
- Add a variety of accessories to the side panels
- Contents: foams FF1A81, FF1A189, FF1A229, FF1A230 and 3875-GLOVE included

			PCS/STK								
1475KXL6CBKFFSDFFSD	7314150461615	1	234	986x501x1100 mm	1100 kg	445 mm	543 mm	30 kg	150 mm	50 mm	9005



FF1A81 - SCREWDRIVERS & WRENCHES	
B191.040.100	SCREWDRIVER STRAIGHT 4.0X0.8X100
B190.055.125	SCREWDRIVER SLOTTED 5.5X1X125
B190.065.150	SCREWDRIVER SLOT 6.5X1.2X150
B192.000.075	SCREWDRIVER PH0X75
B192.001.100	SCREWDRIVER PH1X100
B192.002.125	SCREWDRIVER PH2X125
111M-6	COMBINATION WRENCH
111M-7	COMBINATION WRENCH
111M-8	COMBINATION WRENCH
111M-9	COMBINATION WRENCH
111M-10	COMBINATION WRENCH
111M-11	COMBINATION WRENCH
111M-12	COMBINATION WRENCH
111M-13	COMBINATION WRENCH
111M-14	COMBINATION WRENCH
111M-15	COMBINATION WRENCH
111M-16	COMBINATION WRENCH
111M-17	COMBINATION WRENCH
111M-19	COMBINATION WRENCH
111M-21	COMBINATION WRENCH
111M-22	COMBINATION WRENCH
111M-24	COMBINATION WRENCH
BE-9770-B	SCREWDRIVER SET HEX 1,5-10 BULK



FF1A189 - STRIKING & CUTTING TOOL	
3734S/6-T	COTTER PIN PUNCHES TROLLEY SET
479-16	BALL PEIN HAMMER
3625W-35	NYLON TIP MALLET 35 MM.
MTG-3-16	3M TAPE MEASURE 16MM CARDED
KB18-01	18MM SNAP OFF BLADE KNIFETPR
KSBG18-10DISPEN	18MM SNAPOFF BLADE10 DISPENSER
2101G-180IPS	SIDE CUTTER 2101G-180
2630GC-180IP	COMBINATION PLIER 180MM ERGO
2470G-200	SNIPER NOSE PLIER 2470G-200
720031	PICK UP TOOL- 4 CLAWS
8224 IP	SLIP JOINT PLIER 8224 W/O CARD

1475KXL6CBKFFSD

Campaign trolley with tools – 234 tools



FF1A229 - SOCKETS, RATCHETS, BITS	
6950RN	RATCHET 1/4,ROUND TYPE
8150RN-1/2	RATCHET 1/2,ROUND TYPE
BULK57SZ1-2-4B ***	57X SOCKETS BULK 1-2 AND 1-4
59/S100B	100 PCS BIT SET
6950CBR	BIT-RATCHET 1/4IN

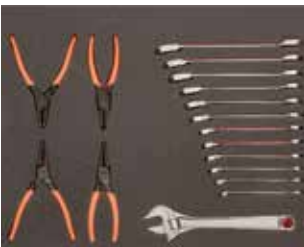

FF1A230 - WRENCHES AND PLIERS	
1RM-8	RATCHET COMB.SPANNER
1RM-8	RATCHET COMB.SPANNER
1RM-8	RATCHET COMB.SPANNER
1RM-8	RATCHET COMB.SPANNER
1RM-8	RATCHET COMB.SPANNER
1RM-8	RATCHET COMB.SPANNER
1RM-8	RATCHET COMB.SPANNER
1RM-8	RATCHET COMB.SPANNER
1RM-8	RATCHET COMB.SPANNER
1RM-8	RATCHET COMB.SPANNER
1RM-8	RATCHET COMB.SPANNER
1RM-8	RATCHET COMB.SPANNER
1RM-8	RATCHET COMB.SPANNER
1RM-8	RATCHET COMB.SPANNER
1RM-8	RATCHET COMB.SPANNER
28-29/S4	CIRCLIP PLIERS SET 19-60MM
8072 C	ADJUSTABLE WRENCH 8072 C 10"

*** COMPOSITION OF BULK57SZ1-2-4B

- 1/4" Socket HEX 4
- 1/4" Socket HEX 4,5
- 1/4" Socket HEX 5
- 1/4" Socket HEX 5,5
- 1/4" Socket HEX 6
- 1/4" Socket HEX 7
- 1/4" Socket HEX 8
- 1/4" Socket HEX 9
- 1/4" Socket HEX 10
- 1/4" Socket HEX 11
- 1/4" Socket HEX 12
- 1/4" Socket HEX 13
- 1/4" Long sockets HEX 7
- 1/4" Long sockets HEX 8
- 1/4" Long sockets HEX 9
- 1/4" Long sockets HEX 10
- 1/4" Long sockets HEX 11
- 1/4" Long sockets HEX 13
- 1/4" Socket HEX 14
- 1/4" Spinner
- 1/4" Extension 100mm
- 1/4" U joint
- 1/2" Sockets HEX 10
- 1/2" Sockets HEX 11
- 1/2" Sockets HEX 12
- 1/2" Sockets HEX 13
- 1/2" Sockets HEX 14
- 1/2" Sockets HEX 15
- 1/2" Sockets HEX 16
- 1/2" Sockets HEX 17
- 1/2" Sockets HEX 18
- 1/2" Sockets HEX 19
- 1/2" Sockets HEX 20
- 1/2" Sockets HEX 21
- 1/2" Sockets HEX 22
- 1/2" Sockets HEX 24
- 1/2" Sockets HEX 27
- 1/2" Sockets HEX 30
- 1/2" Sockets HEX 32
- 1/2" Sockets LONG 10
- 1/2" Sockets LONG 13
- 1/2" Sockets LONG 16
- 1/2" Sockets LONG 17
- 1/2" Sockets LONG 18
- 1/2" Sockets LONG 19
- 1/2" Sockets LONG 22
- 1/2" spark plug 16mm
- 1/2" spark plug 21mm
- 1/2" Extension 125mm
- 1/2" Extension 250mm
- 1/2" joint
- 1/2" breaker bar
- 1/2 sq 5/16 hex Bit holder
- 1/4 sq 1/4 hex Bit holder
- 5/16" Bits - T45
- 5/16" Bits - T50
- 5/16" Bits - T55





1475KXL8BK303SD

Tool trolley general maintenance - 295 pcs

- 8 drawer extra large capacity trolley
- Lock & Go! latching system prevents drawers from opening when the trolley is being moved
- Fully opening 30kg capacity drawers equipped with ball-bearing sliders for smooth opening
- Inside and outside of the case and drawers have a scratch-proof and anti-rust powder coating
- Double walled case: if the outside wall is damaged in a collision, the drawers will always open
- Solid steel construction: the double walled case is strengthened with strategically positioned welding points
- Anti-slip rubber worktop
- A solid handle that can be fixed in both side of the trolley
- Strong and secure round locking system protects the trolley against theft
- Noiseless rubber wheels 150x50 mm with 2 brakes ensure maximum stability : 2 fixed and 2 swivel with brake
- Available in different colours
- Add a variety of accessories to the side panels
- Content: foams FF1B13, FF1B14, FF1B15 and FF1B16

1475KXL8BK303SD	7314150568246	1	295	986x501x1100 mm	1100 kg	445 mm	880 mm	30 kg	150 mm	50 mm	9005



FF1B13 - WRENCHES	
111M-10	COMBINATION WRENCH
111M-11	COMBINATION WRENCH
111M-12	COMBINATION WRENCH
111M-13	COMBINATION WRENCH
111M-14	COMBINATION WRENCH
111M-15	COMBINATION WRENCH
111M-16	COMBINATION WRENCH
111M-17	COMBINATION WRENCH
111M-18	COMBINATION WRENCH
111M-19	COMBINATION WRENCH
111M-20	COMBINATION WRENCH
111M-21	COMBINATION WRENCH
111M-22	COMBINATION WRENCH
111M-24	COMBINATION WRENCH
111M-27	COMBINATION WRENCH
111M-30	COMBINATION WRENCH
111M-32	COMBINATION WRENCH
111M-6	COMBINATION WRENCH
111M-7	COMBINATION WRENCH
111M-8	COMBINATION WRENCH
111M-9	COMBINATION WRENCH
1RM-10	RATCHET COMB. SPANNER
1RM-11	RATCHET COMB. SPANNER
1RM-12	RATCHET COMB. SPANNER
1RM-13	RATCHET COMB. SPANNER
1RM-14	RATCHET COMB. SPANNER
1RM-15	RATCHET COMB. SPANNER
1RM-16	RATCHET COMB. SPANNER
1RM-17	RATCHET COMB. SPANNER
1RM-18	RATCHET COMB. SPANNER
1RM-19	RATCHET COMB. SPANNER
1RM-21	RATCHET COMB. SPANNER
1RM-22	RATCHET COMB. SPANNER
1RM-24	RATCHET COMB. SPANNER
1RM-8	RATCHET COMB. SPANNER
1RM-9	RATCHET COMB. SPANNER
6M-10-11	OPEN END WRENCH
6M-12-13	OPEN END WRENCH
6M-14-15	OPEN END WRENCH
6M-16-17	OPEN END WRENCH
6M-18-19	OPEN END WRENCH
6M-20-22	OPEN END WRENCH
6M-21-23	OPEN END WRENCH
6M-24-27	OPEN END WRENCH
6M-30-32	OPEN END WRENCH
6M-6-7	OPEN END WRENCH
6M-8-9	OPEN END WRENCH
92C	ADJUSTABLE WRENCH 8" SIDE NUT



FF1B14 - SOCKETS	
6700TORX-E10	SOCKET 1/4"
6700TORX-E4	SOCKET 1/4"
6700TORX-E5	SOCKET 1/4"
6700TORX-E6	SOCKET 1/4"
6700TORX-E7	SOCKET 1/4"
6700TORX-E8	SOCKET 1/4"
7800TORX-E10	SOCKET 1/2"
7800TORX-E12	SOCKET 1/2"
7800TORX-E14	SOCKET 1/2"
7800TORX-E16	SOCKET 1/2"
7800TORX-E18	SOCKET 1/2"
7800TORX-E20	SOCKET 1/2"
7800TORX-E24	SOCKET 1/2"
7805GPR-16	SPARK PLUG SOCKET 1/2-16 MM
7805GPR-21	SPARK PLUG SOCKET 1/2-21 MM
BE5049	SET OF BITS
D/S14	IMPACT SOCKET SET 1/2 DRIVE
DD/S14	IMPACT DEEP SOCKET SET 1/2
S560	SOCKET SET 1/4" & 1/2"

1475KXL8BK303SD**Tool trolley general maintenance - 295 pcs****FF1B16 - PLIERS AND STRIKING TOOLS**

2101G-180IP	SIDE CUTTER 2101D-180
2470 G-200	SNIPER NOSE PLIER 2470G-200
2530	PICK UP TOOL 4-CLAWS
2678 G-180	COMB PLIER 2678 G-180
2800-180	CIRCLIP PLIER 2800-180
2890-180	CIRCLIP PLIER 2890-180
2900-180	CIRCLIP PLIER 2900-180
2951-250	GRIP WITH WIRE CUTTER 250
2990-180	CIRCLIP PLIER 2990-180
3625W-35	NYLON TIP Mallet 35 MM.
3734S/6	COTTER PIN PUNCHES TROLLEY SET
479-16	BALL PEIN HAMMER
8224 IP	SLIP JOINT PLIER 8224 W/O CARD
BE-9770	SCREW.DR.SET HEX 1,5-10
CR B 03	TERMINAL PLIER GREEN HAN 220MM
KB18-01	18MM SNAP OFF BLADE KNIFETPR
KSBG18-10DISPEN	18MM SNAPOFF BLADE10 DISPENSER
MTG-3-16	3M TAPE MEASURE 16MM CARDED

FF1B15 - SCREWDRIVERS

59/S31B	31PCS BIT SET RETAIL
700-1.5-50	PRECISION SCREW FLAT 1.5X50
700-2.5-50	PRECISION SCREW FLAT 2.5 X 50
700-3.5-75	PRECISION SCREW FLAT 3.5 X 75
701-1-75	PRECISION SCREW PH 1 X 75
703-6-50	PRECISION SCREW TORX 6 X 50
703-8-50	PRECISION SCREW TORX 8 X 50
806-1-1	MAINS TESTER 3X65150-250V
901T-010-100	TORX T-HANDLE 10 X 100
901T-015-150	TORX T-HANDLE 15 X 150
901T-020-150	TORX T-HANDLE 20 X 150
901T-025-150	TORX T-HANDLE 25 X 150
901T-027-150	TORX T-HANDLE 27 X 150
901T-030-200	TORX T-HANDLE 30 X 200
901T-040-200	TORX T-HANDLE 40 X 200
901T-045-200	TORX T-HANDLE 45 X 200
901T-050-200	TORX T-HANDLE 50 X 200
B141.010.075	SCREWDRIVER TORX TAMPER TR10X75
B141.015.100	SCREWDRIVER TORX TAMPER TR15X100
B141.020.100	SCREWDRIVER TORX TAMPER TR20X100
B141.025.125	SCREWDRIVER TORX TAMPER TR25X125
B141.030.150	SCREWDRIVER TORX TAMPER TR30X150
B190.055.125	SCREWDRIVER SLOTTED 5.5X1X125
B191.030.075	SCREWDRIVER STRAIGHT 3.0X0.5X75
B191.040.100	SCREWDRIVER STRAIGHT 4.0X0.8X100
B192.001.100	SCREWDRIVER PH1X100
B192.002.125	SCREWDRIVER PH2X125
B195.001.025	STUBBY SCREWDRIVER PH1X25
B195.002.025	STUBBY SCREWDRIVER PH2X25
B195.040.025	STUBBY STRAIGHT 4.0X0.8X25
B195.050.025	STUBBY STRAIGHT 5.0X1.0X25
B196.030.100	INSULATED SCREWDRIVER SLOT 3X0.5X100
B196.040.100	INSULATED SCREWDRIVER SLOT 4.0X0.8X100
B196.055.125	INSULATED SCREWDRIVER SLOT 5.5X1.0X125
B197.000.075	INSULATED SCREWDRIVER PH0X75
B197.001.080	INSULATED SCREWDRIVER PH1X80
B197.002.100	INSULATED SCREWDRIVER PH2X100
B705.1/4.125	BIT HOLDER SCREWDRIVER 1/4"





LARGE

Tool trolley general purpose tool kit - 346 pcs

- Heavy duty tool trolley composed of 7 drawer E72 trolley plus foam assortment
- Fully opening drawers equipped with ball-bearing slides for smooth motion with load capacity up to 30 kg
- Rubber wheels ensure maximum stability, making the trolley easy to manoeuvre even on irregular surfaces
- Perforated side panels allow users to add various Xpand accessories
- Strong and secure cylindrical locking system protects the tool trolley against theft
- Scratchproof powder coating outside and inside ensures high protection against rust
- Shock protection corner bumpers minimise the risk of injuries and damage to surrounding objects
- Dual-walled case ensures that the drawers still open after collision damage to the outer wall
- Replace the standard anti-slip rubber top with stainless steel, MDF or chestnut to meet the needs of every job
- Contents: FF1ASET-LARGE

			PCS/STK										
LARGE	7314150437429	1	346	952x510x782 mm	600 kg	50/116/246 mm	543 mm	445 mm	30 kg	125 mm	30 mm	9005	



FF1A207LM - BITS, SOCKETS AND BITHOLDER		Qty
1150-1/2H/P	CALIPER 150 MM	1
59/S100BC	100 PCS COLOUR BIT SET	100
808050L	RATCHETING BIT SCREW.WITH LEDS	6
2058-BR	BIT-RATCHET 1/4"	1
K6650-1/4-1P	BIT ADAPTOR 1/4" 50 MM	1
6956	NUT DRIVER	1
6963	EXTENSION, FLEX.	1
K6650-3/8-1P	ADAPTOR 1/4" 50 MM 3/8 W/PIN	1
8967/S3	FLAT ADAPTER SET ALL SIZES	3
6966	UNIVERSAL JOINT	1
6954	T-HANDLE	1
696EX-08	1/4" KNURLED EXTENSION	1
904T-060-150	BIT HOLDER T HANDLE	1
905T-060-100	SOCKET DRIVER T HANDLE	1
6973A	BIT HOLDER 1/4" SQ TO 1/4" HEX	1
SL25L	SOCKET SET 1/4" STD+DEEP	37
S330	SOCKET SET	34



FF1A208LM - SOCKETS AND CUTTING TOOLS		Qty
2744	MULTI-PURPOSE SNIP	1
7809M-10	SOCKET 1/2"	1
7809M-12	SOCKET 1/2"	1
7809M-14	SOCKET 1/2"	1
7809M-4	SOCKET 1/2"	1
7809M-5	SOCKET 1/2"	1
7809M-6	SOCKET 1/2"	1
7809M-7	SOCKET 1/2"	1
7809M-8	SOCKET 1/2"	1
K7801M-13	POWER SOCKET 1/2"	1
K7801M-15	POWER SOCKET 1/2"	1
K7801M-16	POWER SOCKET 1/2"	1
K7801M-17	POWER SOCKET 1/2"	1
K7801M-18	POWER SOCKET 1/2"	1
K7801M-19	POWER SOCKET 1/2"	1
K7801M-21	POWER SOCKET 1/2"	1
K7801M-22	POWER SOCKET 1/2"	1
K7801M-24	POWER SOCKET 1/2"	1
K8160D-2	POWER SOCKET EXTENSION 1/2"	1
KBGU-10P-DISPEN	UTIL.KNIFE BLADE 10P DISPENSER	10
KERU-01	ERGO RETRACTABLE UTILITY KNIFE	1
319	HACKSAW FRAME	1
K6650-1/2-1P	ADAPTOR 1/4" 50 MM 1/2" W/PIN	1
S240	SOCKET SET 1/2"	24

FF1A209LM - WRENCHES		Qty
111M-8	COMBINATION WRENCH	1
111M-9	COMBINATION WRENCH	1
111M-10	COMBINATION WRENCH	1
111M-11	COMBINATION WRENCH	1
111M-12	COMBINATION WRENCH	1
111M-13	COMBINATION WRENCH	1
111M-14	COMBINATION WRENCH	1
111M-15	COMBINATION WRENCH	1
111M-16	COMBINATION WRENCH	1
111M-17	COMBINATION WRENCH	1
111M-18	COMBINATION WRENCH	1
111M-19	COMBINATION WRENCH	1
111M-20	COMBINATION WRENCH	1
111M-21	COMBINATION WRENCH	1
111M-22	COMBINATION WRENCH	1
111M-24	COMBINATION WRENCH	1
111M-27	COMBINATION WRENCH	1
111M-30	COMBINATION WRENCH	1
111M-32	COMBINATION WRENCH	1
111M-34	COMBINATION WRENCH	1
2535L	MAGNETIC PICK-UP WITH LIGHT	1

LARGE**Tool trolley general purpose tool kit - 346 pcs**

FF1A210LM - SCREWDRIVERS AND WRENCHES		Qty
1RM-8	RATCHET WRENCH	1
1RM-9	RATCHET WRENCH	1
1RM-10	RATCHET WRENCH	1
1RM-11	RATCHET WRENCH	1
1RM-12	RATCHET WRENCH	1
1RM-13	RATCHET WRENCH	1
1RM-14	RATCHET WRENCH	1
1RM-15	RATCHET WRENCH	1
1RM-16	RATCHET WRENCH	1
1RM-17	RATCHET WRENCH	1
1RM-18	RATCHET WRENCH	1
1RM-19	RATCHET WRENCH	1
1520 G	POWER CUTTER	1
2101G-160	SIDE CUTTER	1
2430 G-190HD	SNIPE NOSE CUTTING	1
2628 G-180	COMBINATION PLIER	1
BE-8602	SCREWDRIVER ERGO PH2x25	1
BE-8611	SCREWDRIVER ERGO PH1x75	1
BE-8621	SCREWDRIVER ERGO PH2x100	1
BE-8811	SCREWDRIVER ERGO PZ1x75	1
BE-8821	SCREWDRIVER ERGO PZ2x100	1
BE-8802	SCREWDRIVER ERGO PZ2x25	1
8224	SLIP JOINT PLIER	1
9031	ADJUSTABLE WRENCH	1



FF1A211LM - SCREWDRIVERS		Qty
900T-025-100	HEXAGONAL T-HANDLE 2.5x100	1
900T-030-100	HEXAGONAL T-HANDLE 3x100	1
900T-040-150	HEXAGONAL T-HANDLE 4x150	1
900T-050-150	HEXAGONAL T-HANDLE 5x150	1
900T-060-200	HEXAGONAL T-HANDLE 6x200	1
900T-080-200	HEXAGONAL T-HANDLE 8x200	1
BE-8910	SCREWDRIVER ERGO TX 10x65	1
BE-8915	SCREWDRIVER ERGO TX 15x70	1
BE-8920	SCREWDRIVER ERGO TX 20x80	1
BE-8925	SCREWDRIVER ERGO TX 25x80	1
BE-8930	SCREWDRIVER ERGO TX 30x100	1
BE-8020	SCREWDRIVER ERGO 0.5x3.0x125	1
BE-8050SL	ERGO 1000V SLIM 1.0x5.5x125	1
BE-8040	SCREWDRIVER ERGO 0.8x4.0x100	1
BE-8150	SCREWDRIVER ERGO 1.0x5.5x100	1
BE-8155	SCREWDRIVER ERGO 1.2x6.5x125	1
BE-8355	SCREWDRIVER ERGO 1.2x6.5x25	1
BE-9787	SCREWDRIVER SET HEX 3/32"-3/8"	7
BE-9770	SCREWDRIVER SET HEX 1.5-10 mm	9



FF1A212LM - CUTTING AND STRIKING TOOLS		Qty
1-100-08-2-2	8" HAND, WITH HANDLE, CUT 2	1
1-210-08-2-2	8" 1/2 ROUND, WITH HANDLE, CUT 2	1
1-230-08-2-2	8" ROUND, WITH HANDLE, CUT 2	1
3734-2	COTTER PIN PUNCH	1
3734-3	COTTER PIN PUNCH	1
3734-4	COTTER PIN PUNCH	1
3734-5	COTTER PIN PUNCH	1
3734-6	COTTER PIN PUNCH	1
3734-8	COTTER PIN PUNCH	1
3735-4-120	CENTRE PUNCH	1
3740-150	FLAT CHISEL	1
3740-250	FLAT CHISEL	1
426TOR9	9" TORPEDO ALU LEVEL	1
481-400	GERMAN DIN-HAMMER	1
BE-8986	ERGO AWL STUBBY	1
MTC-5-16-C1	5M SLIM TAPE 16 mm CARDED CLASS 1	1
2446	STAINLESS STEEL CARPENTER KNIFE	1
3625N-32	PLASTIC HAMMER	1





XLARGE

Tool trolley general purpose tool kit - 560 pcs

- Heavy duty tool trolley composed of 9 drawers E77 trolley plus 4 drawers E87 top chest plus foam assortment
- Based on a sturdy steel dual-walled case construction
- The unique 1DAAT system ensures that only one drawer can be opened at a time, avoiding any risk of tilting
- Fully opening drawers with individual shock-protection corner bumpers
- The pivoting latching system avoids unintentional drawer opening
- Wheels with dual braking system secure the trolley solidly to the ground, preventing movement in any direction
- Unrivalled customisation possibilities thanks to perforated side panels and individual top design
- Xpand modular accessories system available to allow users to configure the perfect workstation
- Ultimate locking system with electronic access control available
- Scratchproof powder coating outside and inside ensures high protection against rust
- Dual-walled case ensures that the drawers still open after collision damage to the outer wall
- Replace the standard composite top with stainless steel, MDF or chestnut to meet the needs of every job
- Contents: FF1ASET-XLARGE set

XLARGE	7314150437412	1	560	1360x510x820 mm	1400 kg	50/116 mm	543 mm	445 mm	45 kg	125 mm	36 mm	9005

FF1A195LM - SOCKETS 1/4"		Qty
A6800DZ-9/16	SOCKET 1/4"	1
A6800DZ-1/2	SOCKET 1/4"	1
A6800DZ-1/4	SOCKET 1/4"	1
A6800DZ-11/32	SOCKET 1/4"	1
A6800DZ-3/16	SOCKET 1/4"	1
A6800DZ-3/8	SOCKET 1/4"	1
A6800DZ-5/16	SOCKET 1/4"	1
A6800DZ-7/16	SOCKET 1/4"	1
A6800DZ-7/32	SOCKET 1/4"	1
A6800DZ-9/32	SOCKET 1/4"	1
K6625-1/4-1P	ADAPTOR 1/4" 25 mm 1/4" W/BALL	1
K6650-1/4-1P	BIT ADAPTOR 1/4" 50 mm	1
6954	T-HANDLE	1
6963	OFFSET HANDLE 3/4"	1
K6650-3/8-1P	ADAPTOR 1/4" 50 mm 3/8 W/PIN	1
7767	FLAT ADAPTOR 1/4"-3/8"	1
8167	FLAT ADAPTER 3/8"-1/2"	1
2058-BR	BIT-RATCHET 1/4"	1
59/S31B	31 pcs BIT SET RETAIL	31
SL25L	SOCKET SET 1/4" STD+DEEP	37
S330L	SOCKET SET 3/8 STD+DEEP	53

FF1A196LM - SOCKETS 1/2"		Qty
7800DZ-1.1/16	SOCKET 1/2"	1
7800DZ-1.1/4	SOCKET 1/2"	1
7800DZ-1.1/8	SOCKET 1/2"	1
7800DZ-1.3/16	SOCKET 1/2"	1
7800DZ-1/2	SOCKET 1/2"	1
7800DZ-11/16	SOCKET 1/2"	1
7800DZ-13/16	SOCKET 1/2"	1
7800DZ-15/16	SOCKET 1/2"	1
7800DZ-25/32	SOCKET 1/2"	1
7800DZ-3/4	SOCKET 1/2"	1
7800DZ-3/8	SOCKET 1/2"	1
7800DZ-5/8	SOCKET 1/2"	1
7800DZ-7/16	SOCKET 1/2"	1
7800DZ-7/8	SOCKET 1/2"	1
7800DZ-9/16	SOCKET 1/2"	1
7800DZ-19/32	SOCKET 1/2"	1
7809M-4	SOCKET 1/2"	1
7809M-5	SOCKET 1/2"	1
7809M-6	SOCKET 1/2"	1
7809M-7	SOCKET 1/2"	1
7809M-8	SOCKET 1/2"	1
7809M-10	SOCKET 1/2"	1
7809M-12	SOCKET 1/2"	1
7809M-14	SOCKET 1/2"	1
7809M-5-100	SOCKET 1/2"	1
7809M-6-100	SOCKET 1/2"	1
7809M-7-100	SOCKET 1/2"	1
7809M-8-120	SOCKET 1/2"	1
7809M-10-140	SOCKET 1/2"	1
K6650-1/2-1P	ADAPTOR 1/4" 50 mm 1/2 W/PIN	1
S1612L	SG40 SOCKET SET 1/2" DEEP	12
8967	FLAT ADAPTER 1/2"-3/4"	1
S240	SOCKET SET 1/2"	24



XLARGE

Tool trolley general purpose tool kit - 560 pcs



FF1A197LM - IMPACT SOCKETS 1/2" AND CUTTING TOOLS		
1150-1/2H/P	CALIPER 150 mm	1
2744	MULTI-PURPOSE SNIP	1
426TOR9	9" TORPEDO ALU LEVEL	1
K7801M-13	POWER SOCKET 1/2"	1
K7801M-15	POWER SOCKET 1/2"	1
K7801M-16	POWER SOCKET 1/2"	1
K7801M-17	POWER SOCKET 1/2"	1
K7801M-18	POWER SOCKET 1/2"	1
K7801M-19	POWER SOCKET 1/2"	1
K7801M-21	POWER SOCKET 1/2"	1
K7801M-22	POWER SOCKET 1/2"	1
K7801M-24	POWER SOCKET 1/2"	1
K8160D-2	POWER SOCKET EXTENSION 1/2"	1
K7806M-13	POWER SOCKET 1/2"	1
K7806M-14	POWER SOCKET 1/2"	1
K7806M-16	POWER SOCKET 1/2"	1
K7806M-17	POWER SOCKET 1/2"	1
K7806M-18	POWER SOCKET 1/2"	1
K7806M-19	POWER SOCKET 1/2"	1
K7806M-21	POWER SOCKET 1/2"	1
K7806M-22	POWER SOCKET 1/2"	1
K7806M-24	POWER SOCKET 1/2"	1
KBGU-10P-DISPEN	UTIL. KNIFE BLADE 10P DISPENSER	10
KERU-01	ERGO RETRACTABLE UTILITY KNIFE	1
MTC-5-16-C1	5M SLIM TAPE 16 mm CARDED_CLASS1	1
325	HACKSAW FRAME ERGO	1
1544	FEELER GAUGE	1

FF1A199LM - WRENCHES		
1RM-8	RATCHET WRENCH	1
1RM-9	RATCHET WRENCH	1
1RM-10	RATCHET WRENCH	1
1RM-11	RATCHET WRENCH	1
1RM-12	RATCHET WRENCH	1
1RM-13	RATCHET WRENCH	1
1RM-14	RATCHET WRENCH	1
1RM-15	RATCHET WRENCH	1
1RM-16	RATCHET WRENCH	1
1RM-17	RATCHET WRENCH	1
1RM-18	RATCHET WRENCH	1
1RM-19	RATCHET WRENCH	1
1RM-21	RATCHET WRENCH	1
1RM-22	RATCHET WRENCH	1
1RM-24	RATCHET WRENCH	1
4040M-8-9	FLEX. HEAD WRENCH	1
4040M-10-11	FLEX. HEAD WRENCH	1
4040M-12-13	FLEX. HEAD WRENCH	1
4040M-14-15	FLEX. HEAD WRENCH	1
4040M-16-17	FLEX. HEAD WRENCH	1
4040M-18-19	FLEX. HEAD WRENCH	1
9029	ADJUSTABLE WRENCH	1
9031	ADJUSTABLE WRENCH	1



FF1A198LM - WRENCHES		Qty
111M-8	COMBINATION WRENCH	1
111M-9	COMBINATION WRENCH	1
111M-10	COMBINATION WRENCH	1
111M-11	COMBINATION WRENCH	1
111M-12	COMBINATION WRENCH	1
111M-13	COMBINATION WRENCH	1
111M-14	COMBINATION WRENCH	1
111M-15	COMBINATION WRENCH	1
111M-16	COMBINATION WRENCH	1
111M-17	COMBINATION WRENCH	1
111M-18	COMBINATION WRENCH	1
111M-19	COMBINATION WRENCH	1
111M-20	COMBINATION WRENCH	1
111M-21	COMBINATION WRENCH	1
111M-22	COMBINATION WRENCH	1
111M-24	COMBINATION WRENCH	1
111M-27	COMBINATION WRENCH	1
111M-30	COMBINATION WRENCH	1
111M-32	COMBINATION WRENCH	1
111M-34	COMBINATION WRENCH	1



XLARGE

Tool trolley general purpose tool kit - 560 pcs



FF1A200LM - PLIERS		
1520 G	POWER CUTTER	1
1620	QUICK-ADJUST ERGO PIPE WRENCH	1
2101G-160	SIDE CUTTER	1
2223 S-150	STRIPPING PLIER	1
2233 D-160	CUTTING/STRIPPING PLIERS	1
2430 G-190HD	SNIPE NOSE CUTTING 200	1
2628 G-180	COMBINATION PLIER	1
2890-180	CIRCLIP PLIER	1
2990-180	CIRCLIP PLIER	1
C3330R	PRECISION DIAGONAL CUTTER T&R	1
C3530	ROUND NOSE PLIERS	1
C3230	PRECISION END CUTTER	1
C3640	NEEDLE NOSE PLIERS LONG	1
8224	SLIP JOINT PLIER	1



FF1A202LM - SCREWDRIVERS & L KEYS		
900T-025-100	HEXAGONAL T-HANDLE 2.5x100	1
900T-030-100	HEXAGONAL T-HANDLE 3x100	1
900T-040-150	HEXAGONAL T-HANDLE 4x150	1
900T-050-150	HEXAGONAL T-HANDLE 5x150	1
900T-060-200	HEXAGONAL T-HANDLE 6x200	1
900T-080-200	HEXAGONAL T-HANDLE 8x200	1
BE-8907	SCREWDRIVER ERGO TX 7x75	1
BE-8908	SCREWDRIVER ERGO TX 8x75	1
BE-8909	SCREWDRIVER ERGO TX 9x75	1
BE-8910	SCREWDRIVER ERGO TX 10x75	1
BE-8915	SCREWDRIVER ERGO TX 15x100	1
BE-8920	SCREWDRIVER ERGO TX 20x100	1
BE-8925	SCREWDRIVER ERGO TX 25x125	1
BE-8927	SCREWDRIVER ERGO TX 27x125	1
BE-8930	SCREWDRIVER ERGO TX 30x150	1
BE-8702	SCREWDRIVER ERGO HEX BALL 2x100	1
BE-8725	SCREWDRIVER ERGO HEX BALL 2.5x100	1
BE-9770	SCREWDRIVER SET HEX 1.5-10	9
BE-9785	SCREWDRIVER SET HEX 0.050-3/8	13



FF1A201LM - SCREWDRIVERS		
BE-8256TB	ERGO THROUGH BLADE 1.6x8.0x150	1
BE-8620TB	ERGO THROUGH BLADE PH2x100	1
BE-8623TB	ERGO THROUGH BLADE PH3x150	1
700-2-50	PRECISION SCREWDRIVER FLAT 2x50	1
701-00-50	PRECISION SCREWDRIVER PH 00x50	1
701-0-50	PRECISION SCREWDRIVER PH 0x50	1
701-1-75	PRECISION SCREWDRIVER PH 1x75	1
703-10-50	PRECISION SCREWDRIVER TORX 10x50	1
703-15-75	PRECISION SCREWDRIVER TORX 15x75	1
703-6-50	PRECISION SCREWDRIVER TORX 6x50	1
703-7-50	PRECISION SCREWDRIVER TORX 7x50	1
703-8-50	PRECISION SCREWDRIVER TORX 8x50	1
703-9-50	PRECISION SCREWDRIVER TORX 9x50	1
BE-8040SL	ERGO 1000V SLIM 0.8x4.0x100	1
BE-8040	SCREWDRIVER ERGO 0.8x4.0x100	1
BE-8150	SCREWDRIVER ERGO 1.0x5.5x100	1
BE-8155	SCREWDRIVER ERGO 1.2x6.5x125	1
BE-8256	SCREWDRIVER ERGO 1.6x8.0x150	1
BE-8355	SCREWDRIVER ERGO 1x6x25	1
BE-8600	SCREWDRIVER ERGO PH0x60	1
BE-8602	SCREWDRIVER ERGO PH2x25	1
BE-8611	SCREWDRIVER ERGO PH1x75	1
BE-8621	SCREWDRIVER ERGO PH2x100	1
BE-8623	SCREWDRIVER ERGO PH3x150	1
BE-8811	SCREWDRIVER ERGO PZ1x75	1
BE-8821	SCREWDRIVER ERGO PZ2x100	1
BE-8802	SCREWDRIVER ERGO PZ2x2	1
BE-8870	SCREWDRIVER ERGO 1.6x10x175	1
BE-9787	SCREWDRIVER SET HEX 3/32-3/8	9

XLARGE

Tool trolley general purpose tool kit - 560 pcs



FF1A203LM - SCREWDRIVERS & BITS		
59/S100BC	100 pcs COLOUR BIT SET RETAIL	100
808050L	RATCHETING BIT SCREWDRIVER W/ LEDS	6
2058-BR	BIT-RATCHET 1/4"	1
901T-010-100	TORX T-HANDLE 10x100	1
901T-015-150	TORX T-HANDLE 15x150	1
901T-020-150	TORX T-HANDLE 20x150	1
901T-025-150	TORX T-HANDLE 25x150	1
901T-027-150	TORX T-HANDLE 27x150	1
901T-030-200	TORX T-HANDLE 30x200	1
901T-040-200	TORX T-HANDLE 40x200	1

FF1A205LM - PRYBARS & INSPECTION		
2484-45	PRY BAR 450 mm	1
2633/S4	AWLS AND HOOKS, SET	4
2951-180	GRIP WITH WIRE CUTTER	1
5515T	TELESCOPIC MIRROR	1
BE66152	STRAP WRENCH 6"-150 mm	1
BE-8986	ERGO AWL STUBBY	1
BT10P330	MULTI POSITION PRYBAR 300	1
2681	RIVET GUN	1
1450D-ISO	DOUBLE THREAD RESTORER	1
806-1-3	AUTO TESTER 3x45 6-24V	1
5515FL	ORIENTABLE MIRROR W/LIGHT	1



FF1A204LM - SLUGGING TOOLS		
1-100-08-2-2	8" HAND, WITH HANDLE, CUT 2	1
1-170-08-2-2	8" 3 SQUARE, WITH HANDLE, CUT 2	1
1-210-08-2-2	8" 1/2 ROUND, WITH HANDLE, CUT 2	1
1-230-08-2-2	8" ROUND, WITH HANDLE, CUT 2	1
1435/5	STUD EXTRACTOR SET	5
3734-2	COTTER PIN PUNCH	1
3734-3	COTTER PIN PUNCH	1
3734-4	COTTER PIN PUNCH	1
3734-5	COTTER PIN PUNCH	1
3734-6	COTTER PIN PUNCH	1
3734-8	COTTER PIN PUNCH	1
3735-4-120	CENTRE PUNCH	1
3735-5-120	CENTRE PUNCH	1
3740-150	FLAT CHISEL	1
3740-250	FLAT CHISEL	1
481-400	GERMAN DIN-HAMMER	1
7865	IMPACT DRIVER SET	15
3625N-32	PLASTIC HAMMER	1
1418-4	STUD EXTRACTOR	1
1418-5	STUD EXTRACTOR	1
1418-6	STUD EXTRACTOR	1
1418-7.5	STUD EXTRACTOR	1

FF1A206LM - 3/4" DRIVE SOCKET SET		
SLX 17	SOCKET SET 3/4" 22-50 MM	17





XXL

53" Tool trolley general purpose tool kit - 488 pcs

- Heavy duty 53" tool trolley composed of 7 drawer trolley plus foam assortment
- Complete 53" foam laser marked inlays and drawers to hold extra large tools
- The unique 1DAAT system ensures that only one drawer can be opened at a time, avoiding any risk of tilting
- Lock&Go latching system prevents drawers from opening when the trolley is being moved
- Fully opening drawers with aluminium trim
- Scratchproof powder coating
- Double walled to ensure that the drawers still open after collision damage to the outer wall
- Sturdy steel construction: the double walled case is strengthened with strategically positioned welds
- Sturdy handle can be fitted on either side of the trolley
- Strong and secure cylindrical lock system protects the trolley against theft
- Noiseless rubber wheels 150x50 mm with two brakes ensure maximum stability: Castors (2 fixed and 2 swivel with brake)
- Replace the standard anti-slip rubber top with stainless steel or wood to meet the needs of every job
- Add a variety of accessories to the side

XXL	7314150504152	1	488	986x501x1430 mm	1089 kg	50/116 mm	1217 mm	445 mm	45 kg	150 mm	50 mm	9005



MODULE 1 - SOCKETRY

A6800DM-10	SOCKET 1/4", AEROSPACE
A6800DM-11	SOCKET 1/4", AEROSPACE
A6800DM-12	SOCKET 1/4", AEROSPACE
A6800DM-13	SOCKET 1/4", AEROSPACE
A6800DM-14	SOCKET 1/4", AEROSPACE
A6800DM-4	SOCKET 1/4", AEROSPACE
A6800DM-5	SOCKET 1/4", AEROSPACE
A6800DM-5.5	SOCKET 1/4", AEROSPACE
A6800DM-6	SOCKET 1/4", AEROSPACE
A6800DM-7	SOCKET 1/4", AEROSPACE
A6800DM-8	SOCKET 1/4", AEROSPACE
A6800DM-9	SOCKET 1/4", AEROSPACE
A7402DM-10	SOCKET 3/8", AEROSPACE
A7402DM-11	SOCKET 3/8", AEROSPACE
A7402DM-12	SOCKET 3/8", AEROSPACE
A7402DM-13	SOCKET 3/8", AEROSPACE
A7402DM-14	SOCKET 3/8", AEROSPACE
A7402DM-15	SOCKET 3/8", AEROSPACE
A7402DM-16	SOCKET 3/8", AEROSPACE
A7402DM-17	SOCKET 3/8", AEROSPACE
A7402DM-18	SOCKET 3/8", AEROSPACE
A7402DM-19	SOCKET 3/8", AEROSPACE
A7402DM-21	SOCKET 3/8", AEROSPACE
A7402DM-7	SOCKET 3/8", AEROSPACE
A7402DM-8	SOCKET 3/8", AEROSPACE
A7402DM-9	SOCKET 3/8", AEROSPACE
K6625-1/4-1P	1XADAPTOR 1/4 25MM 1/4 W/BALL
K6650-1/2-1P	1XADAPTOR 1/4 50MM 1/2 W/PIN
K6650-1/4-1P	BIT ADAPTOR 1/4 50MM RETAIL
K6650-3/8-1P	1XADAPTOR 1/4 50MM 3/8 W/PIN
2058-BR	BIT-RATCHET 1/4IN
6700SM-10	SOCKET 1/4
6700SM-11	SOCKET 1/4
6700SM-12	SOCKET 1/4
6700SM-13	SOCKET 1/4
6700SM-14	SOCKET 1/4
6700SM-4	SOCKET 1/4
6700SM-4.5	SOCKET 1/4
6700SM-5	SOCKET 1/4

6700SM-5.5	SOCKET 1/4
6700SM-6	SOCKET 1/4
6700SM-7	SOCKET 1/4
6700SM-8	SOCKET 1/4
6700SM-9	SOCKET 1/4
6700TORX-E10	SOCKET 1/4"
6700TORX-E4	SOCKET 1/4"
6700TORX-E5	SOCKET 1/4"
6700TORX-E6	SOCKET 1/4"
6700TORX-E7	SOCKET 1/4"
6700TORX-E8	SOCKET 1/4"
6950SL	RATCHET 1/4, SLIM HEAD 72T
6954	T-HANDLE
6956	SPINNER HANDLE 1/4
696EX-11	1/4 KNURLED EXTENSION
6960	EXTENSION 1/4 50MM
6962	EXTENSION 1/4 150MM
6962L	EXTENSION BAR 1/4IN 355 MM
6963	EXTENSION, FLEX., 1/4
6966	UNIVERSAL JOINT
6972H	POWER SOCKET HOLDER 1/4
7400SM-10	SOCKET 3/8
7400SM-11	SOCKET 3/8
7400SM-12	SOCKET 3/8
7400SM-13	SOCKET 3/8
7400SM-14	SOCKET 3/8
7400SM-15	SOCKET 3/8
7400SM-16	SOCKET 3/8
7400SM-17	SOCKET 3/8
7400SM-18	SOCKET 3/8
7400SM-19	SOCKET 3/8
7400SM-20	SOCKET 3/8
7400SM-21	SOCKET 3/8
7400SM-22	SOCKET 3/8
7400SM-6	SOCKET 3/8
7400SM-7	SOCKET 3/8
7400SM-8	SOCKET 3/8
7400SM-9	SOCKET 3/8
7400TORX-E10	SOCKET 3/8"
7400TORX-E11	SOCKET 3/8"
7400TORX-E12	SOCKET 3/8"
7400TORX-E14	SOCKET 3/8"
7400TORX-E16	SOCKET 3/8"
7400TORX-E18	SOCKET 3/8"
7400TORX-E8	SOCKET 3/8"
7406ZZ-16	SPARK PLUG SOCKET MAGNET 16MM

7406ZZ-21	SPARK PLUG SOCKET MAGNET 21MM
7409BH-10	SOCKET DRIVER L.3/8IN BALL HEX
7409BH-4	SOCKET DRIVER L. 3/8IN BALL HE
7409BH-5	SOCKET DRIVER L. 3/8IN BALL HE
7409BH-6	SOCKET DRIVER L. 3/8IN BALL HE
7409BH-8	SOCKET DRIVER L. 3/8IN BALL HE
7409F-10	SOCKET DRIVER 3/8IN FLAT TIP
7409F-6.5	SOCKET DRIVER 3/8IN SLOTTED 6,
7409F-8	SOCKET DRIVER 3/8IN SLOTTED 8
7409TORX-R-T27	SOCKET DRIVER 3/8" TAMPER-RES
7409TORX-R-T30	SOCKET DRIVER 3/8" TAMPER-RES
7409TORX-R-T40	SOCKET DRIVER 3/8" TAMPER-RES
7409TORX-R-T45	SOCKET DRIVER 3/8" TAMPER-RES
7409TORX-R-T50	SOCKET DRIVER 3/8" TAMPER-RES
7409TORX-T25	SOCKET DRIVER 3/8IN TORX 25
7409TORX-T27	SOCKET DRIVER 3/8IN TORX 27
7409TORX-T30	SOCKET DRIVER 3/8IN TORX 30
7409TORX-T40	SOCKET DRIVER 3/8IN TORX 40
7409TORX-T45	SOCKET DRIVER 3/8IN TORX 45
7409TORX-T50	SOCKET DRIVER 3/8IN TORX 50
7750SL	RATCHET 3/8, SLIM HEAD 72T
7757	NUT DRIVER
7758	BREAKER BAR
7759	EXTENSION, FLEX. 3/8 L208
776EX-11	3/8 KNURLED EXTENSION
7760	EXTENSION 3/8, 75MM
7761-W	WOBBLE EXTENSION 3/8"-150MM
7764	ADAPTOR 3/8IN TO 1/4IN
7765	ADAPTOR 1/4IN S.D., 3/8IN SOCK
7766	UNIVERSAL JOINT 3/8
7767	FLAT ADAPTOR 1/4-3/8"
7800SM-10	SOCKET 1/2
7800SM-11	SOCKET 1/2
7800SM-12	SOCKET 1/2
7800SM-13	SOCKET 1/2
7800SM-14	SOCKET 1/2
7800SM-15	SOCKET 1/2
7800SM-16	SOCKET 1/2
7800SM-17	SOCKET 1/2
7800SM-18	SOCKET 1/2
7800SM-19	SOCKET 1/2
7800SM-20	SOCKET 1/2
7800SM-21	SOCKET 1/2
7800SM-22	SOCKET 1/2
7800SM-23	SOCKET 1/2
7800SM-24	SOCKET 1/2

XXL**53" Tool trolley general purpose tool kit - 488 pcs**

7800SM-25	SOCKET 1/2
7800SM-26	SOCKET 1/2
7800SM-27	SOCKET 1/2
7800SM-28	SOCKET 1/2
7800SM-29	SOCKET 1/2
7800SM-30	SOCKET 1/2
7800SM-32	SOCKET 1/2
7800SM-33	1/2IN SOCKET 6P , 33 MM
7800SM-34	SOCKET 1/2IN
7800SM-36	SOCKET 1/2
7800SM-8	SOCKET 1/2
7800SM-9	SOCKET 1/2
7800TORX-E10	SOCKET 1/2IN
7800TORX-E11	SOCKET 1/2IN
7800TORX-E12	SOCKET 1/2"
7800TORX-E14	SOCKET 1/2"
7800TORX-E16	SOCKET 1/2"
7800TORX-E18	SOCKET 1/2"
7800TORX-E20	SOCKET 1/2"
7800TORX-E24	SOCKET 1/2"
7800TORX-E8	SOCKET 1/2IN
7805SM-10	SOCKET DEEP 1/2IN
7805SM-12	SOCKET DEEP 1/2IN
7805SM-13	SOCKET DEEP 1/2IN
7805SM-14	SOCKET DEEP 1/2IN
7805SM-15	SOCKET DEEP 1/2IN
7805SM-16	SOCKET DEEP 1/2IN
7805SM-17	SOCKET DEEP 1/2IN
7805SM-18	SOCKET DEEP 1/2IN
7805SM-19	SOCKET DEEP 1/2IN
7805SM-20	SOCKET DEEP 1/2IN
7805SM-21	SOCKET DEEP 1/2IN
7805SM-22	SOCKET DEEP 1/2IN
7805SM-23	SOCKET DEEP 1/2IN
7805SM-24	SOCKET DEEP 1/2IN
7805SM-25	SOCKET DEEP 1/2IN
7805SM-26	SOCKET DEEP 1/2IN

7805SM-27	SOCKET DEEP 1/2IN
7805SM-28	SOCKET DEEP 1/2IN
7805SM-29	SOCKET DEEP 1/2IN
7805SM-30	SOCKET DEEP 1/2IN
7805SM-32	SOCKET DEEP 1/2IN
7809M-10	SOCKET DRIVER 1/2, HEX 10
7809M-10-140	SOCKET DRIVER 1/2IN HEX.LONG
7809M-12	SOCKET DRIVER 1/2, HEX 12
7809M-14	SOCKET DRIVER 1/2, HEX 14
7809M-4	SOCKET DRIVER 1/2, HEX 4
7809M-5	SOCKET DRIVER 1/2, HEX 5
7809M-5-100	SOCKET DRIVER 1/2, HEX 5
7809M-6	SOCKET DRIVER 1/2, HEX 6
7809M-6-100	SOCKET DRIVER 1/2, HEX 6
7809M-7	SOCKET DRIVER 1/2, HEX 7
7809M-7-100	SOCKET DRIVER 1/2IN HEX.LONG
7809M-8	SOCKET DRIVER 1/2, HEX 8
7809M-8-120	SOCKET DRIVER 1/2IN HEX.LONG
7809XZN-10	SOCKET DRIVER 1/2
7809XZN-10-100	SOCKET DRIVER 1/2
7809XZN-12	SOCKET DRIVER 1/2
7809XZN-12-100	SOCKET DRIVER 1/2
7809XZN-14	SOCKET DRIVER 1/2
7809XZN-14-100	SOCKET DRIVER 1/2
7809XZN-16	SOCKET DRIVER 1/2, XZN 16
7809XZN-18	SOCKET DRIVER 1/2, XZN 18
7809XZN-6	SOCKET DRIVER 1/2, XZN 6
7809XZN-8	SOCKET DRIVER 1/2
7809XZN-8-100	SOCKET DRIVER 1/2
8150SL	RATCHET 1/2, SLIM HEAD 72T
8160-3	EXTENSION 1/2 75MM 3IN
8160-5	EXTENSION 1/2 125MM 5IN
8162-W	WOBBLE EXTENSION 1/2"-250MM
8164-1/2	ADAPTORF 3/8" - M 1/2"
8165-1/2	ADAPTOR
8166	UNIVERSAL JOINT 1/2
8167	FLAT ADAPTER 3/8-1/2"

**MODULE 2 - PLIERS**

BE256-155	HOSE CLAMP L:155MM
BE256-178	HOSE CLAMP L:178MM
BE256-250	HOSE CLAMP L:250MM
BLTS7P	7+1 SMD PEN LIGHT
CR W 01	CRIMPING PLIER INSULATED TERM.
2101G-160	SIDE CUTTER 2101G-160
2421 G-140IP	FLAT NOSE PL LONG 140
2421 G-180	FLAT NOSE PL LONG 180
2427 G-200	SNIPE NOSE BENT G 200
2430 G-160	SNIPE NOSE CUTTING 2430G-160
2628 G-180	COMB PLIER 2628 G-180
2800-140	CIRCLIP PLIER INT.STR
2800-180	CIRCLIP PLIER 2800-180
2800-225	CIRCLIP PLIER 2800-225
2890-125	CIRCLIP PLIER INT.BENT.
2890-180	CIRCLIP PLIER 2890-180
2890-210	CIRCLIP PLIER 2890-210
2900-140	EXT.RING PLIER-STRAIGHT 3-10
2900-180	CIRCLIP PLIER 2900-180
2900-215	CIRCLIP PLIER 2900-215
2951-250	GRIP WITH WIRE CUTTER 250
2952-165	GRIP WITH EXTRA LONG NOSE
2990-140	CIRCLIP PLIER 2990-140
2990-180	CIRCLIP PLIER 2990-180
2990-200	CIRCLIP PLIER 2990-200
3416 A	AUT. WIRE STRIPPER (0,2-6MM)
4130	DIAGONAL CUTTER 4130
7224	SLIP JOINT PLIER 250MM



XXL

53" Tool trolley general purpose tool kit - 488 pcs



MODULE 3 - SCREWDRIVERS

BE-7607	NUT DRIVER ERGO
BE-8020L	SCREWDRIVER ERGO 0,5X3X75
BE-8155TB	ERGO THROUGH BLADE 1,2X6,5X125
BE-8256TB	ERGO THROUGH BLADE 1,6X8,0X150
BE-8258TB	ERGO THROUGH BLADE 1,6X10X175
BE-8355	SSCREWDRIVER ERGO 1X6X25
BE-8600	SCREWDRIVER ERGO PH0X60
BE-8602	SCREWDRIVER ERGO PH2X25
BE-8610TB	ERGO THROUGH BLADE PH1X100
BE-8620TB	ERGO THROUGH BLADE PH2X100
BE-8623TB	ERGO THROUGH BLADE PH3X150
BE-8624TB	ERGO THROUGH BLADE PH4X175
BE-8802	SCREW.DR ERGO PZ2X25
BE-8810TB	ERGO THROUGH BLADE PZ1X100
BE-8820TB	ERGO THROUGH BLADE PZ2X100
BE-8823TB	ERGO THROUGH BLADE PZ3X150
BE-8824TB	ERGO THROUGH BLADE PZ4X175
BE-8907	SCREWDRIVER ERGO TX 7X75
BE-8908	SCREWDRIVER ERGO TX 8X75
BE-8909	SCREWDRIVER ERGO TX 9X75
BE-8910	SCREWDRIVER ERGO TX 10X75
BE-8915	SCREWDRIVER ERGO TX 15X100
BE-8920	SCREWDRIVER ERGO TX 20X100
BE-8925	SCREWDRIVER ERGO TX 25X125
BE-8927	SCREWDRIVER ERGO TX 27X125
BE-8930	SCREWDRIVER ERGO TX 30X150
BE-8940	SCREWDRIVER ERGO TX 40X150
BE-8986	ERGO AWL STUBBY
BE-9770	SCREWDRIVER SET HEX 1,5-10
BE-9785	SCREWDRIVER SET HEX 0,050-3/8
MTC-5-16-C1	5M SLIM TAPE 16MMCARDED_CLASS1
1150-1/2H/P	CALIPER 150MM
1544	FEELER GAUCHE
2633/S4	AWLS AND HOOKS, SET
59/S100BC	100 PCS COLOUR BIT SET RETAIL
806-1-3	AUTO TESTER 3X45 6-24V
808050L	RATCHETING BIT SCREW.WITH LEDS

MODULE 4 - MIX

1-170-08-2-2	8" 3 SQUARE,WITH HANDLE,CUT 2
1-210-08-2-2	8" 1/2 ROUND,WITH HANDLE,CUT 2
1-230-08-2-2	8" ROUND,WITH HANDLE,CUT 2
208	HACKSAW FRAMES
2484T-30	PRY BAR 300 MM THROUGH BLADE
2484T-60	PRY BAR 600 MM THROUGH BLADE
2509	FLEX. PICK UP
2535L	MAGNETIC PICK-UP WITH LEDLIGHT
319	HACKSAWFRAM CAMBIAR X 319-3906
3625N-32	PLASTIC HAMMER
3681-16	PRY BAR
3734-2	COTTER PIN PUNCH
3734-3	COTTER PIN PUNCH
3734-4	COTTER PIN PUNCH
3734-5	COTTER PIN PUNCH
3734-6	COTTER PIN PUNCH
3734-8	COTTER PIN PUNCH
3735-4-120	CENTRE PUNCH
3735-5-120	CENTER PUNCH
3740-150	FLAT CHISEL
3740-250	FLAT CHISEL
3906-300-32-5P	HAND HACK SANDFLEX, 5-PACK
479-08	BALL PEIN HAMMER
481-1000	GERMAN DIN-HAMMER
481-400	GERMAN DIN-HAMMER
5515T	TELESCOPIC MIRROR
782-U	UTILITY WIRE BRUSH
8157-36	BREAKERBAR 1/2 36IN METAL HNDL
KBGU-5P-DISPEN	UTILITY KNIFE BLADE 5P DISPENS
KERU-01	1-HAND ERGO PRUNER

MODULE 5 - WRENCHES

1RM-6	RATCHET COMB.SPANNER
1RM-7	RATCHET COMB.SPANNER
1RM-8	RATCHET COMB.SPANNER
1RM-9	RATCHET COMB.SPANNER
1RM-10	RATCHET COMB.SPANNER
1RM-11	RATCHET COMB.SPANNER
1RM-12	RATCHET COMB.SPANNER
1RM-13	RATCHET COMB.SPANNER
1RM-14	RATCHET COMB.SPANNER
1RM-15	RATCHET COMB.SPANNER
1RM-16	RATCHET COMB.SPANNER
1RM-17	RATCHET COMB.SPANNER
1RM-18	RATCHET COMB.SPANNER
1RM-19	RATCHET COMB.SPANNER
1RM-21	RATCHET COMB.SPANNER
1RM-22	RATCHET COMB.SPANNER
1RM-24	RATCHET COMB.SPANNER
1RM-27	RATCHET COMB.SPANNER
1RM-30	RATCHET COMB.SPANNER
1RM-32	RATCHET COMB.SPANNER
111M-10	COMBINATION WRENCH
111M-11	COMBINATION WRENCH
111M-12	COMBINATION WRENCH
111M-13	COMBINATION WRENCH
111M-14	COMBINATION WRENCH
111M-15	COMBINATION WRENCH
111M-16	COMBINATION WRENCH
111M-17	COMBINATION WRENCH
111M-18	COMBINATION WRENCH
111M-19	COMBINATION WRENCH
111M-20	COMBINATION WRENCH
111M-21	COMBINATION WRENCH
111M-22	COMBINATION WRENCH
111M-23	COMBINATION WRENCH
111M-24	COMBINATION WRENCH
111M-25	COMBINATION WRENCH
111M-26	COMBINATION WRENCH
111M-27	COMBINATION WRENCH
111M-28	COMBINATION WRENCH
111M-29	COMBINATION WRENCH
111M-30	COMBINATION WRENCH
111M-32	COMBINATION WRENCH
111M-33	COMBINATION WRENCH
111M-34	COMBINATION WRENCH
111M-36	COMBINATION WRENCH
111M-6	COMBINATION WRENCH
111M-7	COMBINATION WRENCH
111M-8	COMBINATION WRENCH
111M-9	COMBINATION WRENCH
4040M-10-11	FLEX HEAD SPANNER 10-11 MM
4040M-12-13	FLEX HEAD SPANNER 12-13 MM
4040M-14-15	FLEX HEAD SPANNER 14-15 MM
4040M-16-17	FLEX HEAD SPANNER 16-17 MM
4040M-18-19	FLEX HEAD SPANNER 18-19 MM
4040M-8-9	FLEX HEAD SPANNER 8-9 MM
8069	ADJUSTABLE WRENCH 8069 4"
8071	ADJUSTABLE WRENCH 8071 8"
8073	ADJUSTABLE WRENCH 8073 12"



MONSTER

Tool trolley general purpose tool kit - 758 pcs

- Heavy duty 40" tool trolley composed of 8 drawer C75 trolley plus 4 drawer E85 top chest plus foam assortment
- Lock&Go latching system prevents drawers from opening when the trolley is being moved
- Fully opening drawers with aluminium trim
- Scratchproof powder coating
- Sturdy steel construction: The double walled case is strengthened with strategically positioned welds
- A solid handle that can be fixed in both side of the trolley
- Strong and secure cylindrical locking system protects the trolley against theft
- Noiseless rubber wheels 150x50 mm with 2 brakes ensure maximum stability: 2 fixed and 2 swivel with brake
- Replace the standard anti-slip rubber top with stainless steel, MDF or chestnut to meet the needs of every job
- Contents: FF1BSET-MONSTER



MONSTER 7314150437405 1 758 1370x501x100 mm 1300 kg 50/116 mm 445 mm 880 mm 30 kg 150 mm 50 mm 9005

FF1B01LM - SOCKETRY		Qty
6700SM-13	SOCKET 1/4"	1
6700SM-14	SOCKET 1/4"	1
6700SM-4	SOCKET 1/4"	1
6700SM-4.5	SOCKET 1/4"	1
6700SM-5	SOCKET 1/4"	1
6700SM-5.5	SOCKET 1/4"	1
6700SM-6	SOCKET 1/4"	1
6700SM-7	SOCKET 1/4"	1
6700SM-8	SOCKET 1/4"	1
6700SM-9	SOCKET 1/4"	1
6700SM-10	SOCKET 1/4"	1
6700SM-11	SOCKET 1/4"	1
6700SM-12	SOCKET 1/4"	1
6700SZ-1/2	SOCKET 1/4"	1
6700SZ-1/8	SOCKET 1/4"	1
6700SZ-9/16	SOCKET 1/4"	1
6700SZ-1/4	SOCKET 1/4"	1
6700SZ-11/32	SOCKET 1/4"	1
6700SZ-3/16	SOCKET 1/4"	1
6700SZ-3/8	SOCKET 1/4"	1
6700SZ-5/16	SOCKET 1/4"	1
6700SZ-7/16	SOCKET 1/4"	1
6700SZ-7/32	SOCKET 1/4"	1
6700SZ-9/32	SOCKET 1/4"	1
6700SZ-5/32	SOCKET 1/4"	1
6700TORX-E4	SOCKET 1/4"	1
6700TORX-E5	SOCKET 1/4"	1
6700TORX-E6	SOCKET 1/4"	1
6700TORX-E7	SOCKET 1/4"	1
6700TORX-E8	SOCKET 1/4"	1
6700TORX-E10	SOCKET 1/4"	1
6950SL	RATCHET 1/4", SLIM HEAD 72T	1
6962L	EXTENSION BAR 1/4" 355 mm	1
6972H	POWER SOCKET HOLDER 1/4"	1
7400SM-6	SOCKET 3/8"	1
7400SM-7	SOCKET 3/8"	1
7400SM-8	SOCKET 3/8"	1
7400SM-9	SOCKET 3/8"	1
7400SM-10	SOCKET 3/8"	1
7400SM-11	SOCKET 3/8"	1
7400SM-12	SOCKET 3/8"	1
7400SM-13	SOCKET 3/8"	1
7400SM-14	SOCKET 3/8"	1
7400SM-15	SOCKET 3/8"	1
7400SM-16	SOCKET 3/8"	1
7400SM-17	SOCKET 3/8"	1
7400SM-18	SOCKET 3/8"	1

		Qty
7400SM-19	SOCKET 3/8"	1
7400SM-20	SOCKET 3/8"	1
7400SM-21	SOCKET 3/8"	1
7400SM-22	SOCKET 3/8"	1
7400TORX-E10	SOCKET 3/8"	1
7400TORX-E11	SOCKET 3/8"	1
7400TORX-E12	SOCKET 3/8"	1
7400TORX-E14	SOCKET 3/8"	1
7400TORX-E16	SOCKET 3/8"	1
7400TORX-E18	SOCKET 3/8"	1
7406ZZ-16	SPARK PLUG SOCKET MAGNETIC	1
7406ZZ-21	SPARK PLUG SOCKET MAGNETIC	1
7409TORX-R-T27	SOCKET DRIVER 3/8" TAMPER-RES.	1
7409TORX-R-T30	SOCKET DRIVER 3/8" TAMPER-RES.	1
7409TORX-R-T40	SOCKET DRIVER 3/8" TAMPER-RES.	1
7409TORX-R-T45	SOCKET DRIVER 3/8" TAMPER-RES.	1
7409TORX-R-T50	SOCKET DRIVER 3/8" TAMPER-RES.	1
7409TORX-T25	SOCKET DRIVER 3/8"	1
7409TORX-T27	SOCKET DRIVER 3/8"	1
7409TORX-T30	SOCKET DRIVER 3/8"	1
7409TORX-T40	SOCKET DRIVER 3/8"	1
7409TORX-T45	SOCKET DRIVER 3/8"	1
7409TORX-T50	SOCKET DRIVER 3/8"	1
7750SL	RATCHET 3/8, SLIM HEAD 72T	1
2058-BR	BIT-RATCHET 1/4"	1
8164-1/2	ADAPTORF 3/8" - M 1/2"	1
A6800DM-4	SOCKET 1/4"	1
A6800DM-5	SOCKET 1/4"	1
A6800DM-5.5	SOCKET 1/4"	1
A6800DM-6	SOCKET 1/4"	1
A6800DM-7	SOCKET 1/4"	1
A6800DM-8	SOCKET 1/4"	1
A6800DM-9	SOCKET 1/4"	1
A6800DM-10	SOCKET 1/4"	1
A6800DM-11	SOCKET 1/4"	1
A6800DM-12	SOCKET 1/4"	1
A6800DM-13	SOCKET 1/4"	1
A6800DM-14	SOCKET 1/4"	1
A6800DZ-9/16	SOCKET 1/4"	1
A6800DZ-1/2	SOCKET 1/4"	1
A6800DZ-1/4	SOCKET 1/4"	1
A6800DZ-11/32	SOCKET 1/4"	1
A6800DZ-3/16	SOCKET 1/4"	1
A6800DZ-3/8	SOCKET 1/4"	1
A6800DZ-5/16	SOCKET 1/4"	1
A6800DZ-7/16	SOCKET 1/4"	1
A6800DZ-7/32	SOCKET 1/4"	1

		Qty
A6800DZ-9/32	SOCKET 1/4"	1
A7400DZ-1/2	SOCKET 3/8"	1
A7400DZ-11/16	SOCKET 3/8"	1
A7400DZ-3/4	SOCKET 3/8"	1
A7400DZ-3/8	SOCKET 3/8"	1
A7400DZ-5/8	SOCKET 3/8"	1
A7400DZ-7/16	SOCKET 3/8"	1
A7400DZ-17/32	SOCKET 3/8"	1
A7400DZ-9/16	SOCKET 3/8"	1
A7400DZ-19/32	SOCKET 3/8"	1
A7400DZ-13/16	SOCKET 3/8"	1
A7400DZ-7/8	SOCKET 3/8"	1
A7400DZ-1/4	SOCKET 3/8"	1
A7400DZ-5/16	SOCKET 3/8"	1
K6650-1/4-1P	BIT ADAPTOR 1/4" 50 mm RETAIL	1
K6625-1/4-1P	1x ADAPTOR 1/4" 25 mm 1/4" W/BALL	1
6954	T-HANDLE	1
6956	NUT DRIVER	1
6960	EXTENSION	1
6961	EXTENSION	1
6963	EXTENSION, FLEX.	1
6966	UNIVERSAL JOINT	1
7760	EXTENSION	1
7761	EXTENSION	1
7762	EXTENSION	1
7764	ADAPTOR	1
7765	ADAPTOR	1
7766	UNIVERSAL JOINT	1
7409BH-4	SOCKET DRIVER L. 3/8" BALL HEX	1
7409BH-5	SOCKET DRIVER L. 3/8" BALL HEX	1
7409BH-6	SOCKET DRIVER L. 3/8" BALL HEX	1
7409BH-8	SOCKET DRIVER L. 3/8" BALL HEX	1
7409BH-10	SOCKET DRIVER L. 3/8" BALL HEX	1
A7402DM-10	SOCKET 3/8"	1
A7402DM-11	SOCKET 3/8"	1
A7402DM-12	SOCKET 3/8"	1
A7402DM-13	SOCKET 3/8"	1
A7402DM-14	SOCKET 3/8"	1
A7402DM-15	SOCKET 3/8"	1
A7402DM-16	SOCKET 3/8"	1
A7402DM-17	SOCKET 3/8"	1
A7402DM-18	SOCKET 3/8"	1
A7402DM-19	SOCKET 3/8"	1
A7402DM-8	SOCKET 3/8"	1
A7402DM-9	SOCKET 3/8"	1
K6650-3/8-1P	1x ADAPTOR 1/4" 50 mm 3/8" W/PIN	1
7756	3/8 SPINNER HANDLE 150 mm	1

MONSTER

Tool trolley general purpose tool kit - 758 pcs



FF1B02LM - SOCKETS AND ACCESSORIES 1/2"			Qty
7800DM-10	SOCKET 1/2"		1
7800DM-11	SOCKET 1/2"		1
7800DM-12	SOCKET 1/2"		1
7800DM-13	SOCKET 1/2"		1
7800DM-14	SOCKET 1/2"		1
7800DM-15	SOCKET 1/2"		1
7800DM-16	SOCKET 1/2"		1
7800DM-17	SOCKET 1/2"		1
7800DM-18	SOCKET 1/2"		1
7800DM-19	SOCKET 1/2"		1
7800DM-20	SOCKET 1/2"		1
7800DM-21	SOCKET 1/2"		1
7800DM-22	SOCKET 1/2"		1
7800DM-24	SOCKET 1/2"		1
7800DM-27	SOCKET 1/2"		1
7800DM-30	SOCKET 1/2"		1
7800DM-32	SOCKET 1/2"		1
7800DM-34	SOCKET 1/2"		1
7800DM-36	SOCKET 1/2"		1
7800DZ-1	SOCKET 1/2"		1
7800DZ-1.1/16	SOCKET 1/2"		1
7800DZ-1.1/4	SOCKET 1/2"		1
7800DZ-1.1/8	SOCKET 1/2"		1
7800DZ-1.3/16	SOCKET 1/2"		1
7800DZ-1/2	SOCKET 1/2"		1
7800DZ-11/16	SOCKET 1/2"		1
7800DZ-13/16	SOCKET 1/2"		1
7800DZ-15/16	SOCKET 1/2"		1
7800DZ-25/32	SOCKET 1/2"		1
7800DZ-3/4	SOCKET 1/2"		1
7800DZ-3/8	SOCKET 1/2"		1
7800DZ-5/8	SOCKET 1/2"		1
7800DZ-7/16	SOCKET 1/2"		1
7800DZ-7/8	SOCKET 1/2"		1
7800DZ-9/16	SOCKET 1/2"		1
7800DZ-19/32	SOCKET 1/2"		1
7809M-4	SOCKET 1/2"		1
7809M-5	SOCKET 1/2"		1
7809M-6	SOCKET 1/2"		1
7809M-7	SOCKET 1/2"		1
7809M-8	SOCKET 1/2"		1
7809M-10	SOCKET 1/2"		1
7809M-12	SOCKET 1/2"		1
7809M-14	SOCKET 1/2"		1
8150SL	RATCHET 1/2, SLIM HEAD 72T		1
SBS87	BAHCO BREAKER BAR 400 mm 1/2"		1
K7801M-13	POWER SOCKET 1/2"		1
K7801M-15	POWER SOCKET 1/2"		1
K7801M-16	POWER SOCKET 1/2"		1
K7801M-17	POWER SOCKET 1/2"		1
K7801M-18	POWER SOCKET 1/2"		1
K7801M-19	POWER SOCKET 1/2"		1
K7801M-21	POWER SOCKET 1/2"		1
K7801M-22	POWER SOCKET 1/2"		1
K7801M-24	POWER SOCKET 1/2"		1
K8160D-2	POWER SOCKET EXTENSION 1/2"		1
K7806M-13	POWER SOCKET 1/2"		1
K7806M-14	POWER SOCKET 1/2"		1
K7806M-16	POWER SOCKET 1/2"		1
K7806M-17	POWER SOCKET 1/2"		1

			Qty
K7806M-18	POWER SOCKET 1/2"		1
K7806M-19	POWER SOCKET 1/2"		1
K7806M-21	POWER SOCKET 1/2"		1
K7806M-22	POWER SOCKET 1/2"		1
K7806M-24	POWER SOCKET 1/2"		1
7809M-5-100	SOCKET 1/2"		1
7809M-6-100	SOCKET 1/2"		1
7809M-7-100	SOCKET 1/2"		1
7809M-8-120	SOCKET 1/2"		1
7809M-10-140	SOCKET 1/2"		1
K6650-1/2-1P	1x ADAPTOR 1/4" 50 mm 1/2" W/PIN		1
8160-3	EXTENSION 1/2" 75 mm 3"		1
8160-5	EXTENSION 1/2" 125 mm 5"		1
8160-10	EXTENSION 1/2" 250 mm 10"		1
8171	ADAPTOR FEM 1/2" TO MALE 3/8"		1
8166	UNIVERSAL JOINT 1/2"		1



FF1B03LM - WRENCHES			Qty
111M-8	COMBINATION WRENCH		1
111M-9	COMBINATION WRENCH		1
111M-10	COMBINATION WRENCH		1
111M-11	COMBINATION WRENCH		1
111M-12	COMBINATION WRENCH		1
111M-13	COMBINATION WRENCH		1
111M-14	COMBINATION WRENCH		1
111M-15	COMBINATION WRENCH		1
111M-16	COMBINATION WRENCH		1
111M-17	COMBINATION WRENCH		1
111M-18	COMBINATION WRENCH		1
111M-19	COMBINATION WRENCH		1
111M-20	COMBINATION WRENCH		1
111M-21	COMBINATION WRENCH		1
111M-22	COMBINATION WRENCH		1
111M-24	COMBINATION WRENCH		1
111M-27	COMBINATION WRENCH		1
111M-30	COMBINATION WRENCH		1
111M-32	COMBINATION WRENCH		1
111M-34	COMBINATION WRENCH		1
1RM-8	RATCHET WRENCH		1
1RM-9	RATCHET WRENCH		1
1RM-10	RATCHET WRENCH		1
1RM-11	RATCHET WRENCH		1
1RM-12	RATCHET WRENCH		1
1RM-13	RATCHET WRENCH		1
1RM-14	RATCHET WRENCH		1
1RM-15	RATCHET WRENCH		1
1RM-16	RATCHET WRENCH		1
1RM-17	RATCHET WRENCH		1
1RM-18	RATCHET WRENCH		1
1RM-19	RATCHET WRENCH		1
1RM-21	RATCHET WRENCH		1
1RM-22	RATCHET WRENCH		1
1RM-24	RATCHET WRENCH		1
1RM-27	RATCHET WRENCH		1

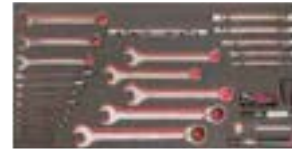

FF1B04LM - WRENCHES			Qty
1RM-30	RATCHET COMB. SPANNER		1
1RM-32	RATCHET COMB. SPANNER		1
111Z-1	COMBINATION WRENCH		1
111Z-1.1/16	COMBINATION WRENCH		1
111Z-1.1/4	COMBINATION WRENCH		1
111Z-1.1/8	COMBINATION WRENCH		1
111Z-1/2	COMBINATION WRENCH		1
111Z-11/16	COMBINATION WRENCH		1
111Z-13/16	COMBINATION WRENCH		1
111Z-15/16	COMBINATION WRENCH		1
111Z-3/4	COMBINATION WRENCH		1
111Z-3/8	COMBINATION WRENCH		1
111Z-5/16	COMBINATION WRENCH		1
111Z-5/8	COMBINATION WRENCH		1
111Z-7/16	COMBINATION WRENCH		1
111Z-7/8	COMBINATION WRENCH		1
111Z-9/16	COMBINATION WRENCH		1
4040M-8-9	FLEX. HEAD WRENCH		1
4040M-10-11	FLEX. HEAD WRENCH		1
4040M-12-13	FLEX. HEAD WRENCH		1
4040M-14-15	FLEX. HEAD WRENCH		1
4040M-16-17	FLEX. HEAD WRENCH		1
4040M-18-19	FLEX. HEAD WRENCH		1
5515T	TELESCOPIC MIRROR		1
BLTS7P	7+1 SMD PEN LIGHT		1
2535L	MAGNETIC PICK-UP WITH LIGHT		1



FF1B05LM - PLIERS			Qty
1150-1/2H/P	CALIPER 150 mm		1
1520 G	POWER CUTTER		1
1620	QUICK-ADJUST ERGO PIPE WRENCH		1
21015-160	SIDE CUTTER		1
21HDG-160	ERGO SIDE CUTTER HD		1
2223 S-150	STRIPPING PLIER		1
2430 G-160	SNIFE NOSE CUTTING		1
2430 S-200	SNIFE NOSE CUTTER		1
2628 G-180	COMB PLIER		1
2628 S-180	COMB PLIER		1
2744	MULTI-PURPOSE SNIP		1
426TOR9	9" TORPEDO ALU LEVEL		1
KBGU-10P-DISPEN	UTIL. KNIFE BLADE 10P DISPENSER		10
KERU-01	ERGO RETRACTABLE UTILITY KNIFE		1
MTC-5-16-C1	5M SLIM TAPE 16 mm CARDED_ CLASS1		1
8224	SLIP JOINT PLIER 8224		1
9029	ADJUSTABLE WRENCH		1
9031	ADJUSTABLE WRENCH		1
806-1-3	AUTO TESTER 3x45 6-24V		1
C3330R	PRECISION DIAGONAL CUTTER T&R		1
C3530	ROUND NOSE PLIERS		1
C3230	PRECISION END CUTTER		1
C3640	NEEDLE NOSE PLIERS LONG		1

MONSTER

Tool trolley general purpose tool kit - 758 pcs



FF1B06LM - SCREWDRIVERS		Qty
700-2.5-50	PRECISION SCREW. FLAT 2.5x50	1
700-2-50	PRECISION SCREW. FLAT 2x50	1
700-3-50	PRECISION SCREW. FLAT 3x50	1
701-00-50	PRECISION SCREW. PH 00x50	1
701-0-50	PRECISION SCREW. PH 0x50	1
701-1-75	PRECISION SCREW. PH 1x75	1
703-10-50	PRECISION SCREW. TORX 10x50	1
703-15-75	PRECISION SCREW. TORX 15x75	1
703-6-50	PRECISION SCREW. TORX 6x50	1
703-7-50	PRECISION SCREW. TORX 6x50	1
703-8-50	PRECISION SCREW. TORX 8x50	1
703-9-50	PRECISION SCREW. TORX 9x50	1
808050L	RATCHETING BIT SCREW. WITH LEDS	6
BE-8010S	SCREWDRIVER ERGO IEC 0.4x2.5x75	1
BE-8020	SCREWDRIVER ERGO 0.5x3.0x60	1
BE-8040SL	ERGO 1000V SLIM 0.8x4.0x100	1
BE-8050SL	ERGO 1000V SLIM 1.0x5.5x125	1
BE-8040	SCREWDRIVER ERGO 0.8x4.0x100	1
BE-8150	SCREWDRIVER ERGO 1.0x5.5x100	1
BE-8155	SCREWDRIVER ERGO 1.2x6.5x125	1
BE-8256	SCREWDRIVER ERGO 1.2x8.0x150	1
BE-8355	SCREWDRIVER ERGO 1.2x6.5x25	1
BE-8600	SCREWDRIVER ERGO PH0x60	1
BE-8600S	SCREWDRIVER ERGO IEC PH0x75	1
BE-8602	SCREWDRIVER ERGO PH2x25	1
BE-8611	SCREWDRIVER ERGO PH1x75	1
BE-8610SL	ERGO 1000V SLIM PH1x80	1
BE-8621	SCREWDRIVER ERGO PH2x100	1
BE-8620SL	ERGO 1000V SLIM PH2x100	1
BE-8623	SCREWDRIVER ERGO PH3x150	1
BE-8702	SCREWDRIVER ERGO HEX BALL 2x110	1
BE-8725	SCREWDRIVER ERGO HEX BALL 2.5x110	1
BE-8820SL	ERGO 1000V SLIM PZ2 x 100	1
BE-8870	SCREWDRIVER ERGO 1.6x10.0x175	1
BE-8975B	HEX KEY FOLDER TX9-40	8
BE-9777B	HEX KEY FOLDER HEX 2.5-10 mm	7
BE-9787	SCREWDRIVER SET HEX 3/32-3/8"	7
BE-9770	SCREWDRIVER SET HEX 1.5-10 mm	9
BE-9785	SCREWDRIVER SET HEX 0.050-3/8"	13



FF1B07LM - SCREWDRIVERS AND BITS		Qty
BE-8256TB	ERGO THROUGH BLADE 1.6x8.0x150	1
BE-8258TB	ERGO THROUGH BLADE 1.6x10.0x175	1
BE-8620TB	ERGO THROUGH BLADE PH2x100	1
BE-8623TB	ERGO THROUGH BLADE PH3x150	1
59/S100BC	100 pcs COLOUR BIT SET RETAIL	100
7455-200	1/2" CLICK TORQUE WRENCH 200 N-m	1
BE-8907	SCREWDRIVER ERGO TX 7x55	1
BE-8908	SCREWDRIVER ERGO TX 8x60	1
BE-8909	SCREWDRIVER ERGO TX 9x60	1
BE-8910	SCREWDRIVER ERGO TX 10x65	1
BE-8915	SCREWDRIVER ERGO TX 15x70	1
BE-8920	SCREWDRIVER ERGO TX 20x80	1
BE-8925	SCREWDRIVER ERGO TX 25x80	1
BE-8927	SCREWDRIVER ERGO TX 27x100	1
BE-8930	SCREWDRIVER ERGO TX 30x100	1
BE-8940	SCREWDRIVER ERGO TX 40x130	1
BE-8811	SCREWDRIVER ERGO PZ1x75	1
BE-8821	SCREWDRIVER ERGO PZ2x100	1
BE-8830	SCREWDRIVER ERGO PZ3x150	1
BE-8802	SCREWDRIVER ERGO PZ2x25	1
BE5049T	SET OF BITS	49
BE-7607	NUT DRIVER ERGO	1



FF1B08LM - FILES, PUNCHES AND EXTRACTORS		Qty
1-100-08-2-2	8" HAND, WITH HANDLE, CUT 2	1
1-170-08-2-2	8" 3 SQUARE, WITH HANDLE, CUT 1	1
1-210-08-2-2	8" 1/2 ROUND, WITH HANDLE, CUT 2	1
1-230-08-2-2	8" ROUND, WITH HANDLE, CUT 2	1
1435/5	STUD EXTRACTOR SET	5
2484-30	PRY BAR 300 mm	1
2484-45	PRY BAR 450 mm	1
2484-60	PRY BAR 600 mm	1
3734-2	COTTER PIN PUNCH	1
3734-3	COTTER PIN PUNCH	1
3734-4	COTTER PIN PUNCH	1
3734-5	COTTER PIN PUNCH	1
3734-6	COTTER PIN PUNCH	1
3734-8	COTTER PIN PUNCH	1
3735-4-120	CENTRE PUNCH	1
3735-5-120	CENTRE PUNCH	1
3740-150	FLAT CHISEL	1
3740-250	FLAT CHISEL	1
4543-3	TWO-ARM PULLER	1
4611-3	NUT SPLITTER 6-36 mm	1
481-400	GERMAN DIN-HAMMER	1
7865	IMPACT DRIVER SET	15
3625N-32	PLASTIC HAMMER	1
1418-4	STUD EXTRACTOR (pin+nut)	1
1418-5	STUD EXTRACTOR (pin+nut)	1
1418-6	STUD EXTRACTOR (pin+nut)	1
1418-7.5	STUD EXTRACTOR (pin+nut)	1

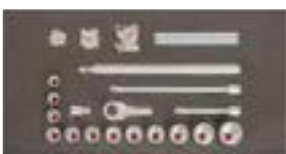

FF1B11LM - SOCKETS		Qty
RAIL-264	METAL RAIL 264 mm	12
CLIPS-1/4	METAL CLIPS FOR 1/4" SOCKETS	25
CLIPS-3/8	METAL CLIPS FOR 3/8" SOCKETS	25
CLIPS-1/2	METAL CLIPS FOR 1/2" SOCKETS	25
SLX 17	SOCKET SET 3/4" - 22>50 mm	17



FF1B10LM - PLIERS		Qty
2633/S4	AWLS AND HOOKS, SET	4
2800-140	CIRCLIP PLIER INT. STRAIGHT 8-15 130	1
2800-180	CIRCLIP PLIER	1
2890-125	CIRCLIP PLIER INT. BENT. 8-15	1
2890-180	CIRCLIP PLIER	1
2900-140	EXT. RING PLIER-STRAIGHT 3-10	1
2900-180	CIRCLIP PLIER	1
2951-180	GRIP WITH WIRE CUTTER 180	1
2952-165	GRIP WITH EXTRA LONG NOSE	1
2963-280	C-CLAMP GRIP 280	1
2965-200	STEEL U CLAMP 300 mm	1
2990-125	EXT.RING PLIER-CURVED 3-10 mm	1
2990-180	CIRCLIP PLIER	1
BE-8986	ERGO AWL STUBBY	1
325	HAND HACK SAW	1
2681	RIVET GUN	1
CR B 02	TERMINAL PLIER RED HANDL 220 mm	1



FF1B09LM - T-HANDLE AND PRY BARS		Qty
900T-025-100	HEXAGONAL T-HANDLE 2.5x100	1
900T-025-100	HEXAGONAL T-HANDLE 2.5x100	1
900T-030-100	HEXAGONAL T-HANDLE 3x100	1
900T-040-150	HEXAGONAL T-HANDLE 4x150	1
900T-050-150	HEXAGONAL T-HANDLE 5x150	1
900T-060-200	HEXAGONAL T-HANDLE 6x200	1
900T-080-200	HEXAGONAL T-HANDLE 8x200	1
901T-010-100	TORX T_HANDLE 10x100	1
901T-015-150	TORX T_HANDLE 15x150	1
901T-020-150	TORX T_HANDLE 20x150	1
901T-025-150	TORX T-HANDLE 25x150	1
901T-027-150	TORX T-HANDLE 27x150	1
901T-030-200	TORX T-HANDLE 30x200	1
901T-040-200	TORX T-HANDLE 40x200	1
BE256-155	HOSE CLAMP L: 155 mm	1
BE256-178	HOSE CLAMP L: 178 mm	1
BE256-250	HOSE CLAMP L: 250 mm	1
BE66152	STRAP WRENCH 6" - 150 mm	1
BT10P325	MULTI POSITION PRYBAR 250	1
BT10P330	MULTI POSITION PRYBAR 300	1
BT10P338	MULTI POSITION PRYBAR 380	1
1544	FEELER GAUCHE	1



1472K7FF28
Tool trolley heavy vehicle maintenance - 302 pcs

- 7 drawers heavy-duty tool trolley is based on a solid steel dual-walled case construction
- Fully opening drawers equipped with ball-bearing sliders that glide very smoothly and have a capacity up to 30 kg
- Rubber wheels ensure maximum stability, making the trolley easy to manoeuvre, even on irregular surfaces
- Perforated side panels allow end-user add different Xpand accessories
- Strong and secure round locking system protects the tool trolley against theft
- Scratchproof powder coating outside and inside assures a high protection against rust
- Shock protecting corner bumpers minimise the chance of injuries and damage to surrounding objects
- Dual-walled case ensures that the drawers always open after a collision damages the outside wall
- A wide range of Fit&Go ready-to-use foam inlays with tools is available
- Content: FF1A08, FF1A117, FF1A170, FF1A150, FF1A2301, FF1A4003, BETMS2330000571.

1472K7FF28	7314150430529	1	302	952x510x782 mm	600 kg	445 mm	543 mm	30 kg	125 mm	30 mm	2009



FF1A08 - SOCKETS	
A6800DM-5.5	SOCKET 1/4IN, AEROSPACE
A6800DM-6	SOCKET 1/4", AEROSPACE
A6800DM-7	SOCKET 1/4", AEROSPACE
A6800DM-8	SOCKET 1/4", AEROSPACE
A6800DM-9	SOCKET 1/4", AEROSPACE
A6800DM-10	SOCKET 1/4", AEROSPACE
A6800DM-11	SOCKET 1/4", AEROSPACE
A6800DM-12	SOCKET 1/4", AEROSPACE
A6800DM-13	SOCKET 1/4", AEROSPACE
A7402DM-10	SOCKET 3/8", AEROSPACE
A7402DM-11	SOCKET 3/8", AEROSPACE
A7402DM-12	SOCKET 3/8", AEROSPACE
A7402DM-13	SOCKET 3/8", AEROSPACE
A7402DM-14	SOCKET 3/8", AEROSPACE
A7402DM-15	SOCKET 3/8IN, AEROSPACE
A7402DM-16	SOCKET 3/8", AEROSPACE
A7402DM-17	SOCKET 3/8", AEROSPACE
A7402DM-18	SOCKET 3/8IN, AEROSPACE
A7402DM-19	SOCKET 3/8", AEROSPACE
1544	FEELER GAUCHE
6950CBR	8MM COMBINATION BITRATCHET 1/4
6700SM-5.5	SOCKET 1/4
6700SM-6	SOCKET 1/4
6700SM-7	SOCKET 1/4
6700SM-8	SOCKET 1/4
6700SM-9	SOCKET 1/4
6700SM-10	SOCKET 1/4
6700SM-11	SOCKET 1/4
6700SM-12	SOCKET 1/4
6700SM-13	SOCKET 1/4
6709M-3	SOCKET DRIVER 1/4IN HEX 3 MM
6709M-4	SOCKET DRIVER 1/4IN HEX 4 MM
6709M-5	SOCKET DRIVER 1/4IN HEX 5 MM
6709M-6	SOCKET DRIVER 1/4IN HEX 6 MM
6709M-8	SOCKET DRIVER 1/4IN HEX 8 MM
6709PH-1	SOCKET DRIVER 1/4IN FOR PH 1
6709PH-2	SOCKET DRIVER 1/4IN FOR PH 2
6709PH-3	SOCKET DRIVER 1/4IN FOR PH 3
6709TORX-T10	SOCKET DRIVER 1/4IN TORX 10
6709TORX-T15	SOCKET 1/4
6709TORX-T20	SOCKET 1/4
6709TORX-T25	SOCKET DRIVER 1/4IN TORX 25
6709TORX-T27	SOCKET DRIVER 1/4IN TORX 27
6709TORX-T30	SOCKET DRIVER 1/4IN TORX 30
6709TORX-T40	SOCKET DRIVER
6709TORX-T8	SOCKET DRIVER 1/4IN TORX 8

6709TORX-T9	SOCKET 1/4
6950SL	RATCHET 1/4, SLIM HEAD 72T
6954-5	1/4 T-HANDLE 125MM
6956	SPINNER HANDLE 1/4
6958-6	1/4" BREAKER BAR 150MM PLASTIC
6960-2	1/4" EXTENSION BAR 50MM - 2
6960-4	1/4" EXTENSION BAR 100MM - 4
6960-6	1/4" EXTENSION BAR 150MM - 6
6960-14	1/4" EXTENSION BAR 355MM-14
6966-CHN	1/4 UNIVERSAL JOINT
6972H	POWER SOCKET HOLDER 1/4
7400SM-6	SOCKET 3/8
7400SM-7	SOCKET 3/8
7400SM-8	SOCKET 3/8
7400SM-9	SOCKET 3/8
7400SM-10	SOCKET 3/8
7400SM-11	SOCKET 3/8
7400SM-12	SOCKET 3/8
7400SM-13	SOCKET 3/8
7400SM-14	SOCKET 3/8
7400SM-15	SOCKET 3/8
7400SM-16	SOCKET 3/8
7400SM-17	SOCKET 3/8
7400SM-18	SOCKET 3/8
7400SM-19	SOCKET 3/8
7400SM-22	SOCKET 3/8
7407H	POWER SOCKET HOLDER 3/8
7409M-10	SOCKET DRIVER 3/8IN HEX 10
7409M-3	SOCKET DRIVER 3/8IN HEX 3
7409M-4	SOCKET DRIVER 3/8IN HEX 4
7409M-5	SOCKET DRIVER 3/8IN HEX 5
7409M-6	SOCKET DRIVER 3/8IN
7409M-7	SOCKET DRIVER 3/8IN HEX 7
7409M-8	SOCKET DRIVER 3/8IN HEX 8
7409TORX-T25	SOCKET DRIVER 3/8IN TORX 25
7409TORX-T27	SOCKET DRIVER 3/8IN TORX 27
7409TORX-T30	SOCKET DRIVER 3/8IN TORX 30
7409TORX-T40	SOCKET DRIVER 3/8IN TORX 40
7409TORX-T45	SOCKET DRIVER 3/8IN TORX 45
7409TORX-T50	SOCKET DRIVER 3/8IN TORX 50
7750SL	RATCHET 3/8, SLIM HEAD 72T
7754-8	3/8 T-HANDLE 200MM - 8 INCH
7758-10	3/8" BREAKER BAR 250MM PLASTIC
7760-3	3/8 EXTENSION BAR 75MM / 3INCH
7760-5	3/8 EXTENSION BAR 125MM / 5INC
7760-10	3/8 EXTENSION BAR 250MM / 10IN

7771	3/8 FEMALE ADAPTOR TO 1/4 MALE
6972	1/4 FEMALE ADAPT. TO MALE 3/8
7766	3/8 UNIVERSAL JOINT
7800SM-10	SOCKET 1/2
7800SM-11	SOCKET 1/2
7800SM-12	SOCKET 1/2
7800SM-13	SOCKET 1/2
7800SM-14	SOCKET 1/2
7800SM-15	SOCKET 1/2
7800SM-16	SOCKET 1/2
7800SM-17	SOCKET 1/2
7800SM-18	SOCKET 1/2
7800SM-19	SOCKET 1/2
7800SM-21	SOCKET 1/2
7800SM-22	SOCKET 1/2
7800SM-24	SOCKET 1/2
7800SM-27	SOCKET 1/2
7800SM-30	SOCKET 1/2
7800SM-32	SOCKET 1/2
7807H	POWER SOCKET HOLDER 1/2
7809M-5	SOCKET DRIVER 1/2, HEX 5
7809M-6	SOCKET DRIVER 1/2, HEX 6
7809M-7	SOCKET DRIVER 1/2, HEX 7
7809M-8	SOCKET DRIVER 1/2, HEX 8
7809M-10	SOCKET DRIVER 1/2, HEX 10
7809M-12	SOCKET DRIVER 1/2, HEX 12
7809M-14	SOCKET DRIVER 1/2, HEX 14
7809M-17	SOCKET DRIVER 1/2IN HEX.
7809M-19	SOCKET DRIVER 1/2IN HEX.
7809TORX-T20	SOCKET 1/2
7809TORX-T25	SOCKET 1/2
7809TORX-T27	SOCKET 1/2
7809TORX-T30	SOCKET 1/2
7809TORX-T40	SOCKET 1/2
7809TORX-T45	SOCKET 1/2
7809TORX-T50	SOCKET 1/2
7809TORX-T55	SOCKET 1/2
7809TORX-T60	SOCKET 1/2
8150SL	RATCHET 1/2, SLIM HEAD 72T
8154-11	SLIDING T-HANDLE 283MM 11IN
8160-5	EXTENSION 1/2 125MM 5IN
8160-10	EXTENSION 1/2 250MM 10IN
7772	3/8 FEMALE ADAPTOR TO 1/2 MALE
8171	ADAPTOR FEM 1/2 TO MALE 3/8
8166	UNIVERSAL JOINT 1/2
8172	ADAPTOR FEM 1/2 TO MALE 3/4

1472K7FF28

Tool trolley heavy vehicle maintenance - 302 pcs



FF1A117 - WRENCHES, ADJ. WRENCHES, SCREWDR.

B191.040.100	SCREWDRIV STRAIGHT 4.0X0.8X100
B190.055.125	SCREWDRIVER SLOTTED 5.5X1X125
B190.065.150	SCREWDRIVER SLOT 6.5X1.2X150
B192.000.075	SCREWDRIVER PH0X75
B192.001.100	SCREWDRIVER PH1X100
B192.002.125	SCREWDRIVER PH2X125
111M-6	COMBINATION WRENCH
111M-7	COMBINATION WRENCH
111M-8	COMBINATION WRENCH
111M-9	COMBINATION WRENCH
111M-10	COMBINATION WRENCH
111M-11	COMBINATION WRENCH
111M-12	COMBINATION WRENCH
111M-13	COMBINATION WRENCH
111M-14	COMBINATION WRENCH
111M-15	COMBINATION WRENCH
111M-16	COMBINATION WRENCH
111M-17	COMBINATION WRENCH
111M-18	COMBINATION WRENCH
111M-19	COMBINATION WRENCH
111M-21	COMBINATION WRENCH
111M-22	COMBINATION WRENCH
111M-24	COMBINATION WRENCH
111M-27	COMBINATION WRENCH
111M-32	COMBINATION WRENCH
8073 IP	ADJUSTABLE WRENCH 8073 IP 12"

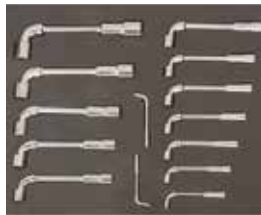

FF1A170 - WRENCHES

28M-8	DOUBLE END SOCKET WRENCH
28M-9	DOUBLE END SOCKET WRENCH
28M-10	DOUBLE END SOCKET WRENCH
28M-11	DOUBLE END SOCKET WRENCH
28M-12	DOUBLE END SOCKET WRENCH
28M-13	DOUBLE END SOCKET WRENCH
28M-14	DOUBLE END SOCKET WRENCH
28M-15	DOUBLE END SOCKET WRENCH
28M-16	DOUBLE END SOCKET WRENCH
28M-17	DOUBLE END SOCKET WRENCH
28M-18	DOUBLE END SOCKET WRENCH
28M-19	DOUBLE END SOCKET WRENCH
28M-22	DOUBLE END SOCKET WRENCH
28M-24	DOUBLE END SOCKET WRENCH



FF1A150 - STRIKING & CUTTING TOOL

3734S/6-T	COTTER PIN PUNCHES TROLLEY SET
481-300	GERMAN DIN-HAMMER
KB18-01	18MM SNAP OFF BLADE KNIFETPR
KSBG18-10DISPEN	18MM SNAPOFF BLADE10 DISPENSER
MTG-3-16	3M TAPE MEASURE 16MM CARDED
2101G-180IP	SIDE CUTTER 2101G-180
2628 G-180IP	COMB PLIER 2628 G-180IP
8224 IP	SLIP JOINT PLIER 8224 W/O CARD
BE-9770	SCREW.DR.SET HEX 1,5-10
482-30	RIVOIR HAMMER
3625W-28	NYLON TIP MALLET 28 MM.
3740-200	FLAT CHISEL
2427 G-200 IP	SNIP NOSE BENT G 200 IP



FF1A2301 - SOCKETRY 3/4 1- 26 PCS3/3

8900DM-19	SOCKET 3/4 BI-HEX. 19 MM
8900DM-22	SOCKET 3/4 BI-HEX. 22 MM
8900DM-23	SOCKET 3/4 BI-HEX. 23 MM
8900DM-24	SOCKET 3/4 BI-HEX. 24 MM
8900DM-25	SOCKET 3/4 BI-HEX. 25 MM
8900DM-26	SOCKET 3/4 BI-HEX. 26 MM
8900DM-27	SOCKET 3/4 BI-HEX. 27 MM
8900DM-28	SOCKET 3/4 BI-HEX. 28 MM
8900DM-29	SOCKET 3/4 BI-HEX. 29 MM
8900DM-30	SOCKET 3/4 BI-HEX. 30 MM
8900DM-32	SOCKET 3/4 BI-HEX. 32 MM
8900DM-33	SOCKET 3/4 BI-HEX. 33 MM
8900DM-34	SOCKET 3/4 BI-HEX. 34 MM
8900DM-36	SOCKET 3/4 BI-HEX. 36 MM
8900DM-41	SOCKET 3/4 BI-HEX. 41 MM
8900DM-46	SOCKET 3/4 BI-HEX. 46 MM
8900DM-50	SOCKET 3/4 BI-HEX. 50 MM
8900DM-55	SOCKET 3/4 BI-HEX. 55 MM
8900DM-60	SOCKET 3/4 BI-HEX. 60 MM
8955N/B	UNIVERSAL HANDLE 3/4"
8954A	SLIDING HEAD3/4 FOR T HANDLE
8957A	3/4 BREAKER BAR HEAD
8960-8	3/4 EXTENSION BAR 200MM 8IN
8971	3/4DECREASING ADAPTOR TO 1/2IN
8966	UNIVERSAL JOINT



BETMS2330000571 - IMPACT WRENCH AND SOCKETS

BPC817	3/4"IMPACT WRENCH
K560F-6	POWER SOCKET ACCESSORY 3/4"
K8164F	POWER SOCKET ADAPTOR 3/4
K8906M-24	IMPACT SOCKET 3/4
K8906M-27	IMPACT SOCKET 3/4
K8906M-30	IMPACT SOCKET 3/4
K8906M-32	IMPACT SOCKET 3/4
K8906M-33	IMPACT SOCKET 3/4
K8906M-36	POWER SOCKET 3/4
K8906M-36	IMPACT SOCKET 3/4
K8906M-41	POWER SOCKET 3/4
K8906M-46	3/4 IMPACT SOCKET L/S 46MM"
K8960F-3	POWER SOCKET EXTENSION 3/4
K8960F-4	IMPACT.EXTENSI.BAR 3/4"-325 MM
K8967S	POWER SOCKET UNIVERS.JOINT 3/4
K9564F	POWER SOCKET ADAPTOR 3/4
7993T0120	HEX BIT IMP.SOCKET 3/4- 12 MM
7993T0140	HEX BIT IMP.SOCKET 3/4- 14 MM
7993T0170	HEX BIT IMP.SOCKET 3/4- 17 MM
7993T0190	HEX BIT IMP.SOCKET 3/4- 19 MM
7993T0220	HEX BIT IMP.SOCKET 3/4- 22 MM
7993T0240	HEX BIT IMP.SOCKET 3/4- 24 MM

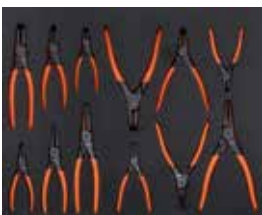

FF1A4003 - MIX PLIERS 2- 12 PCS3/3

2800-150	CIRCLIP PLIER 2800-150
2800-180	CIRCLIP PLIER 2800-180
2800-225	CIRCLIP PLIER 2800-225
2890-140	CIRCLIP PLIER 2890-140
2890-180	CIRCLIP PLIER 2890-180
2890-210	CIRCLIP PLIER 2890-210
2900-150	CIRCLIP PLIER 2900-150
2900-180	CIRCLIP PLIER 2900-180
2900-215	CIRCLIP PLIER 2900-215
2990-140	CIRCLIP PLIER 2990-140
2990-180	CIRCLIP PLIER 2990-180
2990-200	CIRCLIP PLIER 2990-200



1472K7FF13

Tool trolley car body work - 153 pcs

- 7 drawers heavy-duty tool trolley is based on a solid steel dual-walled case construction
- Fully opening drawers equipped with ball-bearing sliders that glide very smoothly and have a capacity up to 30 kg
- Rubber wheels ensure maximum stability, making the trolley easy to manoeuvre, even on irregular surfaces
- Perforated side panels allow end-user add different Xpand accessories
- Strong and secure round locking system protects the tool trolley against theft
- Scratchproof powder coating outside and inside assures a high protection against rust
- Shock protecting corner bumpers minimise the chance of injuries and damage to surrounding objects
- Dual-walled case ensures that the drawers always open after a collision damages the outside wall
- A wide range of Fit&Go ready-to-use foam inlays with tools is available

1472K7FF13	7314150401123	1	153	952x510x782 mm	600 kg	445 mm	543 mm	30 kg	125 mm	30 mm	2009



MODULE 1 - 48 PCS	
479-16	BALL PEIN HAMMER
3625N-32	PLASTIC HAMMER
3735-4-120	CENTRE PUNCH
3734-2	COTTER PIN PUNCH
3734-3	COTTER PIN PUNCH
3734-4	COTTER PIN PUNCH
3734-5	COTTER PIN PUNCH
3734-6	COTTER PIN PUNCH
3734-8	COTTER PIN PUNCH
MTB-3-16	3M TAPE MEASURE 16MM
6700SM-10	SOCKET 1/4"
6700SM-11	SOCKET 1/4"
6700SM-12	SOCKET 1/4"
6700SM-13	SOCKET 1/4"
6700SM-4	SOCKET 1/4"
6700SM-4.5	SOCKET 1/4"
6700SM-5	SOCKET 1/4"
6700SM-5.5	SOCKET 1/4"
6700SM-6	SOCKET 1/4"
6700SM-7	SOCKET 1/4"
6700SM-8	SOCKET 1/4"
6700SM-9	SOCKET 1/4"
6950SL	RATCHET 1/4, SLIM HEAD 72T
6954-5	1/4 T-HANDLE 125MM
6960-2	1/4" EXTENSION BAR 50MM - 2
6960-6	1/4" EXTENSION BAR 150MM - 6
6966-CHN	1/4 UNIVERSAL JOINT
7800SM-10	SOCKET 1/2"
7800SM-12	SOCKET 1/2"
7800SM-13	SOCKET 1/2"
7800SM-14	SOCKET 1/2"
7800SM-15	SOCKET 1/2"
7800SM-16	SOCKET 1/2"
7800SM-17	SOCKET 1/2"
7800SM-18	SOCKET 1/2"
7800SM-19	SOCKET 1/2"
7800SM-21	SOCKET 1/2"
7800SM-22	SOCKET 1/2"
7800SM-23	SOCKET 1/2"
7800SM-24	SOCKET 1/2"
7800SM-27	SOCKET 1/2"
7800SM-30	SOCKET 1/2"
7800SM-32	SOCKET 1/2"
8150SL	RATCHET 1/2, SLIM HEAD 72T
8154-11	SLIDING T-HANDLE 283MM 11IN
8160-3	EXTENSION 1/2 75MM 3IN
8160-5	EXTENSION 1/2 125MM 5IN
8166	UNIVERSAL JOINT 1/2

MODULE 2 - 27 PCS	
111M-6	COMBINATION WRENCH
111M-7	COMBINATION WRENCH
111M-8	COMBINATION WRENCH
111M-9	COMBINATION WRENCH
111M-10	COMBINATION WRENCH
111M-11	COMBINATION WRENCH
111M-12	COMBINATION WRENCH
111M-13	COMBINATION WRENCH
111M-14	COMBINATION WRENCH
111M-15	COMBINATION WRENCH
111M-16	COMBINATION WRENCH
111M-17	COMBINATION WRENCH
111M-18	COMBINATION WRENCH
111M-19	COMBINATION WRENCH
111M-20	COMBINATION WRENCH
111M-21	COMBINATION WRENCH
111M-22	COMBINATION WRENCH
111M-24	COMBINATION WRENCH
111M-27	COMBINATION WRENCH
111M-30	COMBINATION WRENCH
111M-32	COMBINATION WRENCH
2630GC-180IP	COMBINATION PLIER 180MM ERGO
2430	SNIPER NOSE CUTTING PLIER
7224	SLIP JOINT PLIER 7224
2953-250	UNIV.LOCKING CURVED PLIER 250
2101GC-160IP	SIDE CUTTER
SC127	SCISSORS 1000V 125 MM



1472K7FF13**Tool trolley car body work - 153 pcs****MODULE 3 - 45 PCS**

B190.055.125	SCREWDRIVER SLOTTED 5.5X1X125
B191.030.075	SCREWDRIVER STRAIGHT 3.0X0.5X75
B191.040.100	SCREWDRIVER STRAIGHT 4.0X0.8X100
B192.001.100	SCREWDRIVER PH1X100
B192.002.125	SCREWDRIVER PH2X125
B705.1/4.125	BIT HOLDER SCREWDRIVER 1/4"
901T-010-100	TORX T-HANDLE 10 X 100
901T-015-150	TORX T-HANDLE 15 X 150
901T-020-150	TORX T-HANDLE 20 X 150
901T-025-150	TORX T-HANDLE 25 X 150
901T-027-150	TORX T-HANDLE 27 X 150
901T-030-200	TORX T-HANDLE 30 X 200
901T-040-200	TORX T-HANDLE 40 X 200
901T-045-200	TORX T-HANDLE 45 X 200
901T-050-200	TORX T-HANDLE 50 X 200
59S/31-1	BITS SET 31 PCS PH,PZ,T,HEX,SL

**MODULE 4 - 8 PCS**

319-3906	HACKSAW FRAME 319
BBSDA	AMERICAN DOLLY
BBSDC	COMMA DOLLY
BBSDW	WEDGE DOLLY
BBSH1F	DRESSING DOLLY N°3
BBSH2F	DRESSING HAMMER N°4
BBSH3CF	DINGING HAMMER N°1
BBSS1	NARROW SPOON N°2

**MODULE 5 - 18 PCS**

BBS20P12	TRIM REMOVER SET 12P
1-110-08-2-2	8" FLAT, WITH HANDLE, CUT2
1-230-08-2-2	8" ROUND, WITH HANDLE, CUT 2
1178-SCRIBE	SCRIBER CARG.TUNGSTEN
2485	TRIM PAD REMOVER
3740-100	FLAT CHISEL
3740-200	FLAT CHISEL
3750	SLITTING CHISEL

**MODULE 6 - 7 PCS**

2535F1	MAGNETIC PICK UP1 KGR
1419-MD	MAGNETIC DISH
BBSS2	DOUBLE SPOON SHORT
SB-2444	STAINLESS STEEL CARPENTER KNIFE
3-331-14-1-0	14",1/2ROUND PANSAR BLADE,CUT1
9-462-14-0-0	14IN HOLDER FOR 14IN FLAT PANS
1468-M6	NUT RIVETER M3-M6





3149-ORTS1

Cantilever metallic box general purpose tool kit - 69 pcs

- Cantilever metal box filled with tools
- Lid with provision for a padlock
- Tough powder coated finish
- Foldable handle for compact storing
- Box opens easily by pulling handle, providing immediate access to all tool compartments
- With five compartments
- Easy access tool box
- Excellent storage capacity for a range of hand tools and fittings
- Opens up to expose storage trays, no trays to lift out and no drawers to open
- Includes sockets, spanners, wrenches, pliers, etc.

			PCS/STK
3149-ORTS1	7314150292066	1	69

BULK PACKED - 69 PCS		Qty
111M-8	COMBINATION WRENCH	1
111M-9	COMBINATION WRENCH	1
111M-10	COMBINATION WRENCH	1
111M-11	COMBINATION WRENCH	1
111M-12	COMBINATION WRENCH	1
111M-13	COMBINATION WRENCH	1
111M-14	COMBINATION WRENCH	1
111M-15	COMBINATION WRENCH	1
111M-16	COMBINATION WRENCH	1
111M-17	COMBINATION WRENCH	1
111M-18	COMBINATION WRENCH	1
111M-19	COMBINATION WRENCH	1
2171G-160	SIDE CUTTER 2171G-160	1
224 D	SLIP JOINT PLIER 224 D	1
2470 G-200	SNIPE NOSE PLIER 2470G-200	1
2678 G-200	COMB PLIER 2678 G-200	1
2953-250	UNIV. LOCKING CURVED PLIER 250	1
3149-OR	GARAGE TOOL BOX 5 COMP.	1
3625W-28	NYLON TIP MALLET 28 MM.	1

		Qty
3734-3	COTTER PIN PUNCH	1
3734-5	COTTER PIN PUNCH	1
3735-5-120	CENTRE PUNCH	1
3740-150	FLAT CHISEL 18 MM OVAL SHANK	1
3745-150	CAPE CHISEL	1
482-30	RIVOIR HAMMER	1
611-3.5-75	SCRWDRIVER FLAT 3.5X75	1
611-5.5-125	SCRWDRIVER FLAT 5.5X125	1
611-6.5-150	SCRWDRIVER FLAT 6.5X150	1
613-3-100	SCRWDRIVER STRAIGHT 3X100	1
613-4-125	SCRWDRIVER STRAIGHT 4X125	1
615-1-100	SCRWDRIVER PH 1X100	1
615-2-125	SCRWDRIVER PH 2X125	1
615-2-25	SCRWDRIVER PH 2X25	1
615-3-150	SCRWDRIVER PH 3X150	1
BE-9770	SCRWDRIVER SET HEX 1,5-10	9
KBSK-01	SPORTS KNIFE 75MM/3IN BLADE	1
MTG-5-19-E	5M TAPE MEASURE 19MM ENGLISH	1
S240	SOCKET SET 1/2"	24

3149-ORFF1**Cantilever metallic box with foams general purpose tool kit - 69 pcs**

- Cantilever metal box filled with foams and tools
- Lid with provision for a padlock
- Tough powder coated finish
- Foldable handle for compact storing
- Box opens easily by pulling handle, providing immediate access to all tool compartments
- With five compartments
- Easy access tool box
- Excellent storage capacity for a range of hand tools and fittings
- Opens up to expose storage trays; no trays to lift out and no drawers to open
- Includes sockets, spanners, wrenches, pliers, etc.

			PCS/STK				
3149-ORFF1	7314150292479	1	69	220 mm	560 mm	220 mm	14 kg

GENERAL PURPOSE TOOL KIT - 69 PCS

111M-19	COMBINATION WRENCH
111M-18	COMBINATION WRENCH
111M-17	COMBINATION WRENCH
111M-16	COMBINATION WRENCH
111M-15	COMBINATION WRENCH
111M-14	COMBINATION WRENCH
111M-13	COMBINATION WRENCH
111M-12	COMBINATION WRENCH
111M-11	COMBINATION WRENCH
111M-10	COMBINATION WRENCH
111M-8	COMBINATION WRENCH
111M-9	COMBINATION WRENCH
2953-250	UNIV.LOCKING CURVED PLIER 250
224 D	SLIP JOINT PLIER
2171G-160	SIDE CUTTER
2470 G-200	SNIPER NOSE PLIER
BE-9770	SCREW.DR SET HEX 1,5-10
611-3.5-75	SCRWD FLAT 3,5X75
611-5.5-125	SCRWD FLAT 5,5X125
611-6.5-150	SCRWD FLAT 6,5X150
613-3-100	SCRWD STRAIGHT 3X100
613-4-125	SCRWD STRAIGHT 4X125
615-2-25	SCRWD PH 2X25
615-1-100	SCRWD PH 1X100
615-2-125	SCRWD PH 2X125
615-3-150	SCRWD PH 3X150
KBSK-01	SPORTS KNIFE75MM/3IN BLADE
MTG-5-19-E	5M TAPE MEASURE 19MM ENGLISH
482-30	RIVOIR HAMMER
3625W-28	NYLON TIP MALLET 28 MM.
3745-150	CAPE CHISEL
3740-150	FLAT CHISEL 18 MM OVAL SHANK
3734-3	COTTER PIN PUNCH
3734-5	COTTER PIN PUNCH
3735-5-120	CENTRE PUNCH
3149-OR	GARAGE TOOL BOX 5 COMP.
2678 G-200	COMB PLIER 2678 G-200
8160-10	EXTENSION 1/2" 250MM 10"
8160-5	EXTENSION 1/2" 250MM 5"
8158-10	1/2" BREAK.BAR 250MM PLAS.HAND
SBS81	BAHCO REVERSIBLE RATCHET 1/2"
8166	UNIVERSAL JOINT 1/2"
7772H	3/8" TO 1/2" SLIDING ADAPTOR
7800SM-15	SOCKET 1/2"
7800SM-16	SOCKET 1/2"
7800SM-13	SOCKET 1/2"
7800SM-14	SOCKET 1/2"
7800SM-19	SOCKET 1/2"
7800SM-20	SOCKET 1/2"
7800SM-17	SOCKET 1/2"

7800SM-18	SOCKET 1/2"
7800SM-23	SOCKET 1/2"
7800SM-24	SOCKET 1/2"
7800SM-21	SOCKET 1/2"
7800SM-22	SOCKET 1/2"
7800SM-27	SOCKET 1/2"
7800SM-32	SOCKET 1/2"
7800SM-30	SOCKET 1/2"
7800SM-11	SOCKET 1/2"
7800SM-12	SOCKET 1/2"
7800SM-10	SOCKET 1/2"

4750FB2-19ATS1

Electrician tool kit - 46 pcs



- Extremely resistant 19" textile tool bag made of combination of Denier 600 & 1680 polyester fabrics
- 100% waterproof PP hard bottom for isolation and easy cleaning
- Internal detachable extra extra tool panel for better tool distribution
- Pockets, mini- pockets, elastics & dividers outside and inside the bag that fit the different tools
- Hand saw special pocket
- Measuring tape, card and phone holder section
- Spirit level adjustable holder straps
- Velcro straps for long tools & others
- Soft grip handle made of rubberized material provides a User friendly grip and isolates from touching any cold material
- Padded shoulder strap with clicking adjustment
- PVC overmolded zips for easy actioning even with gloves

			PCS/STK
4750FB2-19ATS1	7314150428359	1	46

ELECTRICIAN TOOL KIT - 46 PCS	
BE-9678	GU-SCREW.DR SET HEX BALL 9 PCS
B142.001.080	INSULATED SCREWDRIVER PZ1X80
B142.002.100	INSULATED SCREWDRIVER PZ2X100
B196.035.100	INSULATED SDR SLOT 3.5X0.6X100
B196.040.100	INSULATED SDR SLOT 4.0X0.8X100
B196.055.125	INSULATED SDR SLOT 5.5X1.0X125
B196.065.150	INSULATED SDR SLOT 6.5X1.2X150
B197.001.080	INSULATED SCREWDRIVER PH1X80
B197.002.100	INSULATED SCREWDRIVER PH2X100
CR B 01	TERMINAL PLIER YELLOW 220 MM
MK9	MULTIFITTING 9 MASTER KEY
MTB-3-16	3M TAPE MEASURE 16MM

SCB140G	ELEC. GROOVE SCISSOR 140MM_HD
2101S-160	SIDE CUTTER 2101S-160
2223 S-150	STRIPPING PLIER 2223 S-150
2233 D-200	CUTTING/STRIPPING PLIERS
224 D	ALICATE ARTICULADO 300G
2430 S-160	SNIPE NOSE CUTTER 2430S-160
2628S-160N	COMBI PLIERS 2628S-160
2820EF2	ELEC-KNIFE PLASTIC HNDLE 200MM
3734-2	COTTER PIN PUNCH
3734-3	COTTER PIN PUNCH
3734-4	COTTER PIN PUNCH
3735-5-150	CENTRE PUNCH
4750FB2-19A	19" CLOSED BAG-HARD BOTTOM
483-20	MARTILLO EBANISTA
6M-10-11	OPEN END WRENCH
6M-12-13	OPEN END WRENCH
6M-14-15	OPEN END WRENCH
6M-16-17	OPEN END WRENCH
6M-18-19	OPEN END WRENCH
6M-4-5-5.5	OPEN END WRENCH
6M-4-5	OPEN END WRENCH
6M-6-7	OPEN END WRENCH
6M-8-9	OPEN END WRENCH
806-1-1	MAINS TESTER 3X65150-250V
8072 C IP	ADJUSTABLE WRENCH 8072 C 10"
874602000	MASON'S POINTED CHISEL 200X14
876002000	ELECTRICIAN COLD CHISEL 200X10





FF1A170

Fit&Go 3/3 foam inlay metric double head offset socket spanners set - 14 pcs



- 28M double end socket wrench 8, 9, 10, 11, 12, 13, 14, 15, 16, 17, 18, 19, 22, 24 mm
- Foam available with laser marking
- For general purpose use
- Foam inlay resists Skydrol, petrol, water and UV
- Environmentally friendly foam inlay
- Push system for easy tool extraction
- Foam inlay system for neat and tidy tool organisation
- FOD system: two-colour foam inlays help in identifying missing tools

			PCS/STK				
FF1A170	7314150351800	1	14	40 mm	445 mm	543 mm	6 kg

28M-16, 28M-15, 28M-18, 28M-17, 28M-12, 28M-11, 28M-14, 28M-13, 28M-24, 28M-19, 28M-22, 28M-8, 28M-10, 28M-9



FF1A4003

Fit&Go 3/3 foam inlay circlip pliers set - 12 pcs



- 28M double end socket wrench 8, 9, 10, 11, 12, 13, 14, 15, 16, 17, 18, 19, 22, 24 mm
- Foam available with laser marking
- For general purpose use
- Foam inlay resists Skydrol, petrol, water and UV
- Environmentally friendly foam inlay
- Push system for easy tool extraction
- Foam inlay system for neat and tidy tool organisation
- FOD system: two-colour foam inlays help in identifying missing tools

			PCS/STK				
FF1A4003	7314150286706	1	12	35 mm	445 mm	543 mm	2.41 kg

2800-150, 2800-180, 2800-225

2890-140, 2890-180, 2890-210

2900-150, 2900-180, 2900-215

2990-140, 2990-180, 2990-200

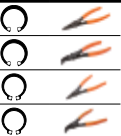

FF1A1011

Fit&Go 3/3 Hex/TORX T-handle screwdriver set - 12 pcs

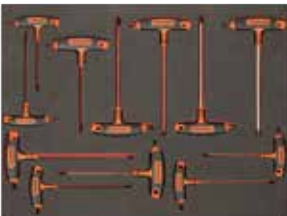

- 903T-2 TORX® and 903T-1 hex screwdrivers
- Offers premium hand tools, quality tool storage and a wide assortment of inlays to suit every need
- Foam available with laser marked

			PCS/STK				
FF1A1011	7314150339068	1	12	35 mm	445 mm	543 mm	1.42 kg

903T-2

903T-1





FF1A2301

Fit&Go 3/3 foam inlay 3/4" socket set - 26 pcs



- 8954-15 sliding T-handle
- 8960-8 extension bar
- 8971 adaptor, 3/4" to 1/2"
- 8966 universal joint
- 8900DM-19 3/4" socket bi-hex 19 mm
- 8900DM-22 3/4" socket bi-hex 22 mm
- 8900DM-23 3/4" socket bi-hex 23 mm
- 8900DM-24 3/4" socket bi-hex 24 mm
- 8900DM-25 3/4" socket bi-hex 25 mm
- 8900DM-26 3/4" socket bi-hex 26 mm
- 8900DM-27 3/4" socket bi-hex 27 mm
- 8900DM-28 3/4" socket bi-hex 28 mm
- 8900DM-29 3/4" socket bi-hex 29 mm
- 8900DM-30 3/4" socket bi-hex 30 mm
- 8900DM-32 3/4" socket bi-hex 32 mm
- 8900DM-33 3/4" socket bi-hex 33 mm
- 8900DM-34 3/4" socket bi-hex 34 mm
- 8900DM-36 3/4" socket bi-hex 36 mm
- 8900DM-41 3/4" socket bi-hex 41 mm
- 8900DM-46 3/4" socket bi-hex 46 mm
- 8900DM-50 3/4" socket bi-hex 50 mm
- 8900DM-55 3/4" socket bi-hex 55 mm
- 8900DM-60 3/4" socket bi-hex 60 mm
- 8955N/B handle universal for 8955N/A
- 8954-15A sliding head for 8955N/B
- 8957-19A head for articulated handle 3/4"
- Foam available with laser marked

			PCS/STK				
FF1A2301	7314150286508	1	26	70 mm	445 mm	543 mm	12.69 kg

8900DM-19, 8900DM-22, 8900DM-23, 8900DM-24, 8900DM-25, 8900DM-26, 8900DM-27, 8900DM-28, 8900DM-29, 8900DM-30, 8900DM-32, 8900DM-33, 8900DM-34, 8900DM-36, 8900DM-41, 8900DM-46, 8900DM-50, 8900DM-55, 8900DM-60		
8954, 8954-15		
8954A		
8958A		
8961		
8965, 8971		
8966		
8955N/B		
8957A		
8960-8		

1000 V **FF1ASET-AUTO12A****1000V tools for hybrids and electrical cars - 45 pcs**

- 45 1000V insulated tools for hybrids and electrical cars



			PCS/STK
FF1ASET-AUTO12A	7314150506446	1	45

FOAM CONTENT

B150.010.100	INSULATED SCREWDRIVER T10X100
B150.015.125	INSULATED SCREWDRIVER T15X125
B150.020.125	INSULATED SCREWDRIVER T20X125
B150.025.150	INSULATED SCREWDRIVER T25X150
B196.030.100	INSULATED SCREWDRIVER SLOT 3X0.5X100
B196.040.100	INSULATED SCREWDRIVER SLOT 4.0X0.8X100
B196.055.125	INSULATED SCREWDRIVER SLOT 5.5X1.0X125
B197.001.080	INSULATED SCREWDRIVER PH1X80
B197.002.100	INSULATED SCREWDRIVER PH2X100
SC127V	SCISSORS 1000V 125 MM
2MV-10	SAFETY S. BOX-END WRENCH
2MV-12	SAFETY S. BOX-END WRENCH
2101S-160	SIDE CUTTER 2101S-160
2430 S-200	SNIP NOSE CUTTER 2430S-200
2630SC-180	COMBI HD PLIERS 2630SC-180
2820VDE	VDE CABLE KNIFE
2820VGCOT	COTTON GLOVES FOR INS.GLOVES
2820VG10	INSULATING GLOVES 1000V-S10
6MV-10	SAFETY OPEN END WRENCH
6MV-11	SAFETY OPEN END WRENCH
6MV-12	SAFETY OPEN END WRENCH
6MV-13	SAFETY OPEN END WRENCH
6MV-14	SAFETY OPEN END WRENCH
6MV-17	SAFETY OPEN END WRENCH
6MV-19	SAFETY OPEN END WRENCH
6MV-7	SAFETY OPEN END WRENCH
6MV-8	SAFETY OPEN END WRENCH
7800DMV-10	1/2" SAFETY SOCKET
7800DMV-11	1/2" SAFETY SOCKET
7800DMV-12	1/2" SAFETY SOCKET
7800DMV-13	1/2" SAFETY SOCKET
7800DMV-14	1/2" SAFETY SOCKET
7800DMV-15	1/2" SAFETY SOCKET
7800DMV-16	1/2" SAFETY SOCKET
7800DMV-17	1/2" SAFETY SOCKET
7800DMV-18	1/2" SAFETY SOCKET
7800DMV-19	1/2" SAFETY SOCKET
7800DMV-20	1/2" SAFETY SOCKET
7800DMV-21	1/2" SAFETY SOCKET
7800DMV-22	1/2" SAFETY SOCKET
7800DMV-8	1/2" SAFETY SOCKET
8150-1/2V	REV.RATCHET WRENCH SAFETY
8154-1/2V	SAFETY T HAND 1/2" SQ.H
8160-1/2V	1/2" SAFETY SHORT.EXT.BA
8162-1/2V	1/2" SAFETY LONG EXT.BAR



1495TP-AUTO-M1

Tool panel auto repair tool kit - 62 pcs

- Tool panel filled with tools ideal for bearing work
- Tools and hooks included
- Silk screen markings give users a clear indication of where to locate tools and hooks
- Top part allows the panel to be hung on a rail
- Rail compatible with the panel available for screw mounting on a wall - code 1495TP09-RAIL

				PCS/STK			
1495TP-AUTO-M1		7314150438266	1	62	500 mm	25 mm	900 mm
1495TP09							
BP910							
BP909TH							
BE-9678							
BE-9675							
29M-30							
2997-250							
1995LM-9, 1995LM-8, 1995LM-6							
3750							
1177-SCRIBE							
K7801M-9, K7801M-10, K7801M-11, K7801M-12, K7801M-13, K7801M-14, K7801M-15, K7801M-16, K7801M-17, K7801M-18, K7801M-19, K7801M-21, K7801M-22, K7801M-23, K7801M-24, K7801M-30, K7801M-32							
K7806M-15, K7806M-21, K7806M-24, K7806M-27							
K8901M-32, K8901M-34, K8901M-36							
K8964D							
K8167S							
K8160D-3							
2800-150							
2900-150							
3734S/6							
BE-8258TB							
1495TP-ACHL40x 9, 1495TP-ACHL65x 9, 1495TP-ACHL20x 33							



1495TP-AUTO-M2

Tool panel auto repair tool kit - 53 pcs

- Tool panel filled with tools ideal for transmission and clutch work
- Tools and hooks included
- Silk screen markings give users a clear indication of where to locate the tools and hooks
- Top part allows the panel to be hung on a rail
- Rail compatible with the panel available for screw mounting on a wall - code 1495TP09-RAIL

				PCS/STK			
1495TP-AUTO-M2		7314150438273	1	53	500 mm	25 mm	900 mm
1495TP09							
BE301							
K7801TORX-E10, K7801TORX-E12, K7801TORX-E14, K7801TORX-E16, K7801TORX-E18, K7801TORX-E20							
K8160D-2							
BE301CM							
BWHEPSSH8							
BE51038, BE510310, BE510312							
BP822							
BP825							
1495TP-ACHL40x 25, 1495TP-ACHL65x 4, 1495TP-ACHL20x 29							
1495TP-AC4							



1495TP-AUTO-M3

Tool panel auto repair tool kit - 34 pcs

- Tool panel filled with tools ideal for maintenance work
- Tools and hooks included
- Silk screen markings give users a clear indication of where to locate the tools and hooks
- Top part allows the panel to be hung on a rail
- Rail compatible with the panel available for screw mounting on a wall - code 1495TP09-RAIL

			PCS/STK			
1495TP-AUTO-M3	7314150438280	1	34	500 mm	25 mm	900 mm

1495TP09	
BE1GP5-T	
6968	
BE1SP1F	
BE60F108	
BE6307414F	
BE60FW	
BE1FFWF	
BE63064514F1	
BE6810Z, BE6810	
BE6FCP	
52	
1546	
2421GC-160, 7764, 6962-W, 6954, 8166-1/2	
5515M	
BE1P	
7455-60	
BE1FLD2, BE1FLD1, BE1FLD3	
BE65F65120	
8164-1/2	
BE6302712F	
BE6701VAG	
BE62110	
BE1310P427	
7406ZZ-21, 7406ZZ-16	
BE1SP14L	
BE1GP5	
1495TP-AC3	
1495TP-ACHL20x 38, 1495TP-ACHL40, 1495TP-ACHL65	



1495TP-AUTO-M4

Tool panel auto repair tool kit - 23 pcs

- Tool panel filled with tools ideal for geometry work
- Tools and hooks included
- Silk screen markings give users a clear indication of where to locate the tools and hooks
- Top part allows the panel to be hung on a rail
- Rail compatible with the panel available for screw mounting on a wall - code 1495TP09-RAIL

				PCS/STK			
1495TP-AUTO-M4		7314150438297	1	23	500 mm	25 mm	900 mm
1495TP09							
BS618							
4545-N1, 4545-N11							
4545-1, 4545-2							
MTB-3-16							
361-14							
8900SM-41							
BS52							
8169-1/2, 8165-1/2							
747-22, 747-21, 747-19, 747-17, 747-15, 747-14, 747-13, 747-12							
BS40VAG							
BS56							
BS100PSA1							
BS45BMW							
1495TP-ACHL40x 10, 1495TP-ACHL65x 5, 1495TP-ACHL20x 20							



1495TP-AUTO-M5

Tool panel auto repair tool kit - 32 pcs

- Tool panel filled with tools ideal for geometry work
- Tools and hooks included
- Silk screen markings give users a clear indication of where to locate the tools and hooks
- Top part allows the panel to be hung on a rail
- Rail compatible with the panel available for screw mounting on a wall - code 1495TP09-RAIL

				PCS/STK			
1495TP-AUTO-M5		7314150438303	1	32	500 mm	25 mm	900 mm
1495TP09							
319							
484-1000							
SB3654BM-20							
3625S-44							
B192.004.200							
BE-8258TB							
2484/S4							
B194.030.150, B194.025.125, B194.020.100, B194.010.075							
600.005.012							
BBS165							
K7801TORX-E10, K7801TORX-E12, K7801TORX-E14, K7801TORX-E16, K7801TORX-E18, K7801TORX-E20, K7801TORX-E24							
BBR203P920, BBR203P925, BBR203P930, BBR203P940, BBR203P945, BBR203P950, BBR203P955, BBR203P960							
1495TP-ACHL40x 13, 1495TP-ACHL20x 38							
8226							



1495TP-AUTO-M6

Tool panel auto repair tool kit - 42 pcs

- Tool panel filled with tools ideal for brake work
- Tools and hooks included
- Silk screen markings give users a clear indication of where to locate the tools and hooks
- Top part allows the panel to be hung on a rail
- Rail compatible with the panel available for screw mounting on a wall - code 1495TP09-RAIL

				PCS/STK			
1495TP-AUTO-M4		7314150438310	1	42	500 mm	25 mm	900 mm
1495TP09							
FM10							
782-U							
BBR405							
BBR400							
BBR210P3							
BBR6131							
BBR204							
BBR1501							
BBR501011, BBR50121314							
2900-215							
7823							
BBR100							
1154							
6M-16-17, 6M-14-15							
1949M-17-19, 1949M-12-13, 1949M-10-11, 1949M-8-9							
1495TP-ACHL40x 2, 1495TP-ACHL20x 29							
1495TP-AC3							



1495CD60TS1

Tool cabinets with 2 doors general purpose toolkit - 110 pcs

- Tool cabinet with two doors, tools and hooks
- Doors open to 180° for complete accessibility
- Round lock system with 2 keys included
- Can be hung from wall or placed on the trolley
- Metal panels 1 mm & 2 mm thick
- Built-in practical fully opening drawer 525 mm x 200 mm x 65 mm
- Panel with square 10 mm x 10 mm pattern in front and sides providing flexibility for hook layout
- Compact structure and highly robust
- Includes 1495CD60 2-door wall cabinet
- Includes general purpose composition for panels and cabinets (981001100)

				PCS/STK			
1495CD60TS1		7314150325627	1	110	500 mm	25 mm	900 mm
1495CD60							
981001100							
1495CD-AC1							
1495TP-AC10							



1495CS18TS1

1800 mm tool cabinets with shutter general purpose toolkit - 110 pcs

- Tool cabinet with shutter, tools and hooks
- Steel structure with square hole panel 1 mm thick
- A professional way to store a lot of tools in a limited amount of space
- All of your tools are immediately visible and right at your fingertips
- Spring rolling system and two handles for easier shutter opening/closing
- Panel with square 10x10 mm pattern providing more flexibility for hooks
- Specific holes for hanging on the wall and/or assembling on a workbench for safety
- Includes general purpose composition for panels and cabinets (981001100)
- Round lock system with two keys included

			PCS/STK			
1495CS18TS1	7314150325603	1	110	1800 mm	170 mm	900 mm

1495CS18	
981001100	
1495CS-AC1	
1495TP-AC10	

981001100

General purpose tool kit - 109 pcs



- For general purpose use
- Includes striking and cutting tools, screwdrivers, spanners, wrenches, files, etc.

			PCS/STK
981001100	7314150219902	1	109

1546	FEELER GAUGE 0.05-1.00 13BLADE
2101D-140IP	SIDE CUTTER
2521GC-160	LONG ROUND NOSE PL.160MM PVC
2630GC-180IP	COMBINATION PLIER 180MM ERGO
2630GC-200IP	COMBINATION PLIER 200MM ERGO
2101GC-200HL	SIDE CUTTER
2430 GC-160 IP	SNIPE NOSE CUTTING CHROME 160
2421GC-160	FLAT PLIER
2427 GC-200IP	LONG,ROUND NOSE CHROMED PL 200
2951-250	GRIP WITH WIRE CUTTER 250
2800-180	CIRCLIP PLIER 2800-180
2900-180	CIRCLIP PLIER 2900-180
6224	BOX JOINT SJP 250MM
6M-12-13	OPEN END WRENCH
6M-14-15	OPEN END WRENCH
6M-10-11	OPEN END WRENCH
6M-6-7	OPEN END WRENCH
6M-8-9	OPEN END WRENCH
6M-20-22	OPEN END WRENCH
6M-21-23	OPEN END WRENCH
6M-24-27	OPEN END WRENCH
6M-25-28	OPEN END WRENCH
2M-6-7	RING WRENCH
2M-8-9	RING WRENCH
2M-10-11	RING WRENCH
2M-12-13	RING WRENCH
2M-14-15	RING WRENCH
2M-16-17	RING WRENCH
2M-18-19	RING WRENCH
2M-20-22	RING WRENCH
2M-21-23	RING WRENCH

2M-24-27	RING WRENCH
9-469-00-0-0	FILE CLEANING CARD
1-100-08-2-2	8" HAND,WITH HANDLE,CUT 2
1-100-10-2-2	10" HAND,WITH HANDLE,CUT 2
1-230-08-1-2	8" ROUND,WITH HANDLE,CUT 1
1-170-08-2-2	8" 3 SQUARE,WITH HANDLE,CUT 2
1-210-08-2-2	8" 1/2 ROUND,WITH HANDLE,CUT 2
9048-400	400MM SQUARE
3733-4	DRIFT PUNCH
3734-4	COTTER PIN PUNCH
1998M/10T	OFFSET KEYS SET 10PCS NICKEL
813VDE-3-100	SCREWDRIVER
813-3-75	SCREWDRIVER
813-4-100	SCREWDRIVER
813-5-5-125	SCREWDRIVER
814-100	SCREWDRIVER
815-2-25	SCREWDRIVER
815-1-100	SCREWDRIVER
815-2-125	SCREWDRIVER
9710-8-150	SCREWDR 9710 1,2 X 8 X 150
9710-6.5-125	SCREWDR 9710 1,2 X 6,5 X 125
SC127	ELECTRICIAN'S SCISSORS 127MM
1150-1/2H/P	CALIPER 150MM
2535F1	MAGNETIC PICK UP
3906-300-24-2P	HAND HACK SANDFLEX, 2-PACK
3645-150-C	CHISEL
4544-10	THREE ARM PULLER
3735-4-120	CENTRE PUNCH
3625W-35	NYLON TIP MALLET 35 MM.
479-16	BALL PEIN HAMMER
8150RN-1/2	RATCHET 1/2

8154-1/2	t HANDLE 1/23
8160-1/2	EXTENSION 1/2 250MM 10IN
8162-1/2	EXTENSION 1/2"-250MM
8166-1/2	UNIVERSAL JOINT
869102500	PUNCH SNIP 200 MM
8072 C	ADJUSTABLE WRENCH 8072 C 10"
8071 C	ADJUSTABLE WRENCH 8071 C 8"
225-PLUS	HACKSAW FRAMES
3640-150-C	COLD CHISELS 150 MM
7800DM-18	SOCKET 1/2
7800DM-17	SOCKET 1/2
7800DM-16	SOCKET 1/2
7800DM-11	SOCKET 1/2
7800DM-10	SOCKET 1/2
7800DM-15	SOCKET 1/2
7800DM-14	SOCKET 1/2
7800DM-13	SOCKET 1/2
7800DM-12	SOCKET 1/2
7800DM-19	SOCKET 1/2
7800DM-23	SOCKET 1/2
7800DM-22	SOCKET 1/2
7800DM-21	SOCKET 1/2
7800DM-20	SOCKET 1/2
7800DM-24	SOCKET 1/2
7800DM-26	SOCKET 1/2
7800DM-28	SOCKET 1/2
7800DM-30	SOCKET 1/2
7800DM-32	SOCKET 1/2
7800DM-27	SOCKET 1/2



4750ALC01FF1

Aluminium tool box general purpose toolkit - 145 pcs

- Two inlays for general purpose in Heavy Duty Aluminum case
- Injection moulded ABS walls with strong aluminum construction frame
- Two metal locks with keys
- Ergonomic soft grip handle
- Two special safety hinges
- Includes two tool pallets with elastics
- Document wallet with tool storage room
- Large variety of tools included: combination wrenches, screwdrivers, 1/4" and 1/2" sockets HEX, striking and cutting tools, pliers, bits

4750ALC01FF1	7314150508884	1	145	160 mm	450 mm	320 mm	13.85 kg

111M-14, 111M-15, 111M-16, 111M-17, 111M-18, 111M-19, 111M-8, 111M-9, 111M-10, 111M-11, 111M-12, 111M-13	
BE-9678	
8072 C IP	
224 D	
217IG-160	
2339-220IP	
2678 G-180	
2470 G-160	
SCB140	
B191.030.075, B191.040.125	
B190.055.125, B190.065.150	
B192.001.100, B192.002.125	
806-1-1	
482F-30	
MTB-5-25	
208	
KB18-01	
808050TS	
59S/0.6-4.5-3P, 59S/1.0-5.5-3P, 59S/1.2-6.5-3P	
59S/PH1-3P, 59S/PH2-3P, 59S/PH3-3P, 59S/PH0-3P	
59S/PH2G-3P	
59S/PZ2-3P, 59S/PZ3-3P, 59S/PZ0-3P, 59S/PZ1-3P	
66IM/T20C-2P, 66IM/T15C-2P, 66IM/T10C-2P, 66IM/T40C-2P, 66IM/T30C-2P, 66IM/T27C-2P, 66IM/T25C-2P	
59S/H1.5-3P, 59S/H3-3P, 59S/H2.5-3P, 59S/H4-3P, 59S/H5-3P, 59S/H2-3P, 59S/H6-3P, 59S/H8-3P	
KM6750-11, KM6750-6, KM6750-7, KM6750-8	
KM6750-10, KM6750-13, K6650-1/4-1P, SB6963	
KM653-1P	
KSBG18-10DISPEN	
700-1.5-50, 700-1.2-50, 700-1-50, 700-1.8-50	
701-00-50, 701-0-50	
3906-250-24-5P, 3906-250-32-5P	
3735N-4-120	
3734N-2-150, 3734N-4-150, 3734N-6-150	
SBS60-9, SBS60-10, SBS60-11, SBS60-12, SBS60-13, SBS60-4, SBS60-4.5, SBS60-5, SBS60-5.5, SBS60-6, SBS60-7, SBS60-8	
SBS61	
SBS64	
6960-3	
8160-10, 8160-5	
8158-10	
7800SM-20, 7800SM-21, 7800SM-22, 7800SM-23, 7800SM-24, 7800SM-27, 7800SM-12, 7800SM-13, 7800SM-14, 7800SM-15, 7800SM-16, 7800SM-17, 7800SM-18, 7800SM-19, 7800SM-10, 7800SM-11, 7800SM-30, 7800SM-32	
SBS81	
8166	
7772H	



1483KHD3RB-FF4

Metallic tool box general purpose toolkit - 146 pcs



- Heavy duty rigid case with 146 pieces and 3 drawers
- Metallic case composition aviation mechanics foam set
- Drawers open 100%
- Drawer blocking system for greater safety
- Reinforced aluminium cover
- Contents: FF3A10, FF3A11, FF3A12 & FF3A13 foams
- Suitable for all large airplanes
- 481-500 DIN hammer 500 mm, 3625N-32 plastic hammer, 2509 flexible pick-up tool 525 mm, 2535F2 magnetic pick-up tool 1 kg
- 7800SM 1/2" socket short series 10, 11, 12, 13, 14, 15, 16, 17, 18, 19, 21, 22, 24, 27, 30, 32 mm
- 7809M 1/2" socket driver hex 5, 6, 7, 8, 10, 12, 14, 17, 19 mm
- 7809 1/2" TORX® socket driver, TORX® T20, T25, T27, T30, T40, T45, T50, T55, T60
- 8154-1/2 1/2" T-handle, 8150SL 1/2" ratchet and slim head, 8160-1/2 1/2" extension bar, 125 mm 8162-1/2 1/2" extension bar 250 mm
- 8164-1/2 F 3/8" - M 1/2" adaptor, 8166-1/2 1/2" universal joint, 8165-1/2 F 1/2" - M 3/8" adaptor
- 8964 F1/2" - M 3/8" adaptor, 7807H 1/2" socket holder
- 111M combination wrench 24, 27, 30, 32 mm
- 6M open end wrench 24x27, 30x32
- 808050P pistol handle ratcheting screwdriver, 808050S ratcheting screwdriver, stubby
- 59S/31-1 bit set, Phillips, Pozidriv, TORX®, slotted
- 2047-0.8-4 offset screwdriver 0.8 mm x 4 mm x 100 mm
- 2047PR-1-2 double offset key for Phillips screws PH1-PH2
- BE-8020L ERGO™ screwdriver slotted 0.5 mm x 3 mm x 75 mm
- BE-8030 ERGO™ screwdriver slotted 0.6 mm x 3.5 mm x 75 mm
- BE-8155 ERGO™ screwdriver slotted 1.2 mm x 6.5 mm x 125 mm
- BE-8260 ERGO™ hex profile bolster screwdriver slotted 1.6 mm x 8 mm x 175 mm
- BE-8350 ERGO™ stubby slotted screwdriver 1 mm x 5.5 mm x 25 mm
- BE-8601 / BE-8602 ERGO™ stubby screwdriver Phillips PH1 x 25 mm, PH2 x 25 mm
- BE-8610 / BE-8620 ERGO™ screwdriver Phillips PH1 x 75 mm, PH2 x 100 mm
- BE-9770 black hex L-key set, long ball end 9 pieces, 1.5, 2, 2.5, 3, 4, 5, 6, 8, 10 mm
- MTB-3-16 ERGO™ measuring tape 3 m, 2101GC side cutter 160 mm, 2427 GC-200IP ERGO™ long round nose chromed pliers 200 mm
- 2430 GC-200 IP ERGO™ snipe nose chromed pliers 200 mm, 2628 GC-160IP ERGO™ combination chromed pliers 160 mm
- 8224CIP ERGO™ slip joint pliers
- 3734 Drift punch 3, 5, 8 mm
- 3735-4-120 Centre punch 120 mm, 1177-scribe offset scriber 230 mm, 1150-1/2H/P calliper 150 mm
- 111M combination wrench 6, 7, 8, 9, 10, 11, 12, 13, 14, 15, 16, 17, 18, 19, 21, 22 mm
- 6M open end wrench 6 x 7, 8 x 9, 10 x 11, 12 x 13, 14 x 15, 16 x 17, 18 x 19, 20 mm x 22 mm
- 9070C ERGO™ adjustable wrench chromed 6", 158 mm x 20 mm
- 5515T-52 telescopic swivel head mirror Ø50 mm, 2820EF2 electricians' knife, BFLA01 Q3 LED-torch

1483KHD3RB-FF4	7314150233595	1	146	335 mm	565 mm	260 mm	28.47 kg

1483KHD3RB	
FF3A10	
FF3A11	
FF3A12	
FF3A13	



LIFTING EQUIPMENT





BH12000
Extra low entry trolley jack, 2T

- 2T trolley jack designed for lifting a wide range of standard vehicles
- 70 mm extra low entrance height and 490 mm elevation achievable height
- Dual piston system decreases the number of necessary strokes by 50%
- Extra large foot pedal and composite curved handle for quick, safe and comfortable use
- Steel and PU wheels ensure both excellent durability and silent handling
- Dust cover protects the pistons and spring from being damaged
- Rubber saddle protects vehicle surfaces and prevents slipping
- Foam on the handle prevents damaging the vehicle body
- Equipped with a safety pressure valve and descent speed control system
- CE certified by Official Independent Technical Inspection Association

BH12000	7314150178803	1	2000 kg	70 mm	490 mm	790 mm	+/- 10	119 mm	x	780 mm	364 mm	1270 mm	42.7 kg

	A (mm)	B (mm)	C (mm)	D (mm)	E (mm)	F (mm)	G (mm)	H (mm)	I (mm)
BH12000	1270	364	780	695	282	70	490	155	120

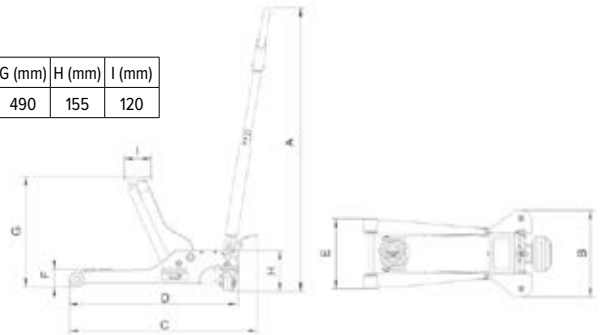

BH15000B
Extra long trolley jack, 5T

- 5T extra long trolley jack allows long reach under the vehicle
- Heavy duty steel construction for maximum durability
- Sturdy steel wheels
- Large and comfortable pedal for easy access from right or left side of lifting points
- Composite curved handle for safe and comfortable use
- Large inbuilt tray for storage of tools, screws, bolts, etc.
- Ø130 steel saddle
- Equipped with a safety pressure valve and descent speed control system
- CE certified by Official Independent Technical Inspection Association

BH15000B	7314150516407	1	5000 kg	150 mm	685 mm	1430 mm	49	130 mm	X	330x520x1670 mm	70 kg



BH110000B
Extra long trolley jack, 10T

- 10T extra long trolley jack allows long reach under the vehicle
- Heavy duty steel construction for maximum durability
- Sturdy steel wheels
- Large and comfortable pedal for easy access from right or left side of lifting points
- Composite curved handle for safe and comfortable use
- Large inbuilt tray for storage of tools, screws, bolts, etc.
- Ø150 steel saddle
- Equipped with a safety pressure valve and descent speed control system
- CE certified according to Directive 2006/42/EC

BH110000B	7314150516414	1	10000 kg	160 mm	685 mm	1550 mm	85	130 mm	X	270x520x1670 mm	117 kg

BH1A1500A

Aluminium trolley jack, 1.5 T

- 1.5 T trolley jack with 100% aluminium structure for racing and road service
- Weighs just 12.8 kg
- Low entry height 85 mm
- High lifting height 415 mm
- Supplied with a nylon carry bag
- Quick approach to the load thanks to the dual piston system
- Equipped with a handy tool tray
- Foam and rubber sleeves on the handle prevents damage to vehicle bodies
- Wheels made of aluminium
- CE certified by Official Independent Technical Inspection Association



										A	B	C	D	E	F	G	H	
BH1A1500A	7314150460946	1	1500 kg	85 mm	415 mm	542 mm	5	97 mm	Yes	1060 mm	250 mm	218 mm	542 mm	85 mm	415 mm	130 mm	97 mm	12.8 kg



BH1A2500A

Aluminium trolley jack, 2.5 T

- 2.5 T trolley jack with 100% aluminium structure for road and indoor workshop services
- Weighs just 24.4 kg
- Low entry height 100 mm
- High lifting height 485 mm
- Quick approach to the load thanks to the dual piston system
- Dust cover protects the pistons and spring from being damaged
- Equipped with a handy tool tray
- Foam and rubber sleeves on the handle prevents damaging vehicle bodies
- Nylon front and rear wheels ensure both excellent durability and silent handling
- CE certified by Official Independent Technical Inspection Association



										A	B	C	D	E	F	G	H	
BH1A2500A	7314150460953	1	2500 kg	100 mm	485 mm	655 mm	6	116 mm	Yes	1380 mm	350 mm	278 mm	655 mm	100 mm	485 mm	163 mm	116 mm	24.4 kg



BH23015

Air-hydraulic jack 30T/15T

- 30T maximum load capacity
- Heavy duty design ensures durability and long tool life
- The support wheel located on the lever prevents injuries when positioning
- PU protection on the steel lever helps prevent scratches to the vehicle
- Soft grip transport handle
- Extra large and thick Nylon+PU wheels easily overcome any obstacle and increase manoeuvrability
- Two height adaptors included, 45 and 75 mm, to increase the possible elevation
- Safety pressure valve system prevents overloading
- CE certified by Official Independent Technical Inspection Association



					BAR													
BH23015	7314150178759	1	30000 kg	1/4 in	8-12 bar	150 mm	289 mm	223 /30 T mm	289 /15 T mm	1250x282x810 mm	54.5 kg							

**BH2402010*****Low entry air-hydraulic jack 40/20/10T***

- 40T/20T/10T extra low entry hydro-pneumatic jack
- 40T maximum load capacity
- Extremely low entry level: 125 mm
- Heavy duty design ensures durability and long tool life
- The support wheel located on the lever prevents injuries when positioning
- PU protection on the steel lever helps prevent scratches to the vehicle
- Extra-large and thick Nylon + PU wheels easily overcome any obstacle and increase manoeuvrability
- Two height adaptors included, 45 and 75 mm, to increase the possible elevation
- Safety pressure valve system prevents overloading
- CE certified by Official Independent Technical Inspection Association

					BAR								
BH2402010	7314150178766	1	40000 kg	1/4 in	8-12 bar	125 mm	406 mm	183 /40 T mm	233 /20 T mm	287 /10 T mm	1225x302x825 mm	53 kg	

**BH2604020*****Air-hydraulic jack 60/40/20T***

- 60T/40T/20T hydro-pneumatic jack
- 60T maximum load capacity
- Heavy duty design ensures durability and long tool life
- The support wheel located on the lever prevents injuries when positioning
- PU protection on the steel lever helps prevent scratches to the vehicle
- Soft grip transport handle
- Extra large and thick Nylon+PU wheels easily overcome any obstacle and increase manoeuvrability
- Two height adaptors included, 45 and 75 mm, to increase the possible elevation
- Safety pressure valve system prevents overloading
- CE certified by Official Independent Technical Inspection Association

					BAR								
BH2604020	7314150178773	1	60000 kg	1/4 in	8-12 bar	150 mm	312 mm	206 /60 T mm	255 /40 T mm	312 /20 T mm	1250x295x875 mm	73 kg	

**BH230*****Air hydraulic jack, 30T***

- High elevation hydro-pneumatic jack specially designed for vehicles with higher lifting points, such as agricultural vehicles
- 30T maximum load capacity
- 627 mm maximum achievable elevation height
- Heavy duty design ensures durability and long tool life
- The support wheel located on the lever prevents injuries when positioning
- PU protection on the steel lever helps prevent scratches to the vehicle
- Soft grip transport handle
- Extra-large steel+rubber castors easily overcome any obstacle and increase manoeuvrability
- Three height adaptors included, 45, 100 and 250 mm, to increase the possible elevation
- Safety pressure valve system prevents overloading
- CE certified by Official Independent Technical Inspection Association

					BAR								
BH230	7314150264070	1	30000 kg	1/4 in	8-12 bar	360 mm	627 mm	1500x282x840 mm	95 kg				



BH28050

Air Hydraulic Jacks 80/50T

- 80T maximum load capacity
- Heavy duty design ensures durability and long tool life
- The support wheel on the lever prevents injuries and increases jack manoeuvrability
- PU protection on the steel lever helps prevent scratches to the vehicle
- Soft grip transport handle
- The extra-large and thick steel+rubber wheels easily overcome any obstacles, such as hoses
- Two adaptors included to increase the possible elevation:
 - - 45 mm
 - - 75 mm
- Weight: 106 kg
- Safety pressure valve prevents overloading
- CE certified by Official Independent Technical Inspection Association

					BAR						
BH28050	7314150472222	1	80000 kg	1/4 in	9-12 bar	230 mm	443 mm	341 / 80T mm	443 / 50T mm	380x470x1200 mm	106 kg



BH1S45

Scissor jack, 4T - 5T

- 4T and 5T Scissor jack specially designed for fork lifts, agricultural and industrial vehicles, etc.
- Two-position lift pad allows handling configurations with flat or edged surfaces
- 2 lifting capacities and possibilities
- 4T on the scissor with a 65 mm minimum height and 406 mm maximum height
- 5T on the cylinder with 350 mm minimum height and 710 mm maximum height
- Heavy duty hard chrome plated pump piston and ram for good corrosion resistance
- CE certified according to Directive 2006/42/EC

BH1S45	7314150292295	1	4000 kg	65 mm	425-724 mm	680 mm	22	90 mm	1194 mm	680 mm	212 mm	42 kg



BH4G

Hydraulic bottle jacks

- Welded structure ensures better performance and prevents oil leakages
- Steel forged base for great wear and impact resistance
- Extension screw (N/A BH4G50) allow precise height adjustment
- Serrated saddle provides a secure lifting grip
- Safety valve prevents the ram from being overextended, which would cause damage to the piston
- Suitable to work only in vertical position
- Operating conditions: -20°C to 50°C
- CE certified by Official Independent Technical Inspection Association

BH4G2	7314150557929	6	2000 kg	181 mm	344 mm	105 mm	105 mm	200 mm	2.4 kg
BH4G4	7314150557967	6	4000 kg	193 mm	373 mm	125 mm	110 mm	215 mm	2.9 kg
BH4G6	7314150558001	4	6000 kg	210 mm	416 mm	130 mm	120 mm	230 mm	3.9 kg
BH4G8	7314150558025	2	8000 kg	230 mm	460 mm	140 mm	130 mm	245 mm	4.7 kg
BH4G12	7314150557905	2	12000 kg	230 mm	440 mm	150 mm	140 mm	240 mm	6.3 kg
BH4G20	7314150557943	2	20000 kg	242 mm	452 mm	175 mm	155 mm	245 mm	9.1 kg
BH4G50	7314150557981	1	50000 kg	265 mm	425 mm	225 mm	200 mm	290 mm	25.3 kg

BH4B**Premium hydraulic bottle jacks**

- Designed for intensive and heavy duty use and high demands
- Suitable to work in vertical and horizontal position
- Larger base for increase stability
- Hard chromed lifting piston with nickel plating finish provides longer durability
- Welded structure ensures best performance and prevents oil leakages
- Steel forged base for great wear and impact resistance
- Extension screw (N/A BH4B20 & BH4B30) allows precise height adjustment
- Serrated saddle provides a secure lifting grip
- Safety valve prevents the ram from being overextended, which would cause damage to the piston
- Operating conditions: -20°C to 50°C
- CE certified by Official Independent Technical Inspection Association

BH4B2	7314150557820	10	2000 kg	178 mm	347 mm	135 mm	115 mm	195 mm	2.4 kg
BH4B5	7314150557868	4	5000 kg	198 mm	390 mm	155 mm	115 mm	220 mm	3.6 kg
BH4B8	7314150557882	4	8000 kg	198 mm	392 mm	175 mm	120 mm	220 mm	5.5 kg
BH4B12	7314150557806	2	12000 kg	240 mm	468 mm	200 mm	145 mm	260 mm	7.7 kg
BH4B20	7314150557844	1	20000 kg	270 mm	430 mm	230 mm	180 mm	290 mm	12.4 kg
BH4B30	7314150557783	1	30000 kg	280 mm	445 mm	240 mm	160 mm	335 mm	18.2 kg

BH33000/BH36000**Jack stands (pair)**

- Jack stand with ratcheting positioning system
- Extra large base area improves stability
- It also prevents the unit from sinking into the ground
- Two jack stand models available with different load capacities
- Safety pin locking system
- TÜV approved and GS certified
- Sold in pairs

BH33000	7314150178674	1	3000 kg	300 mm	435 mm	18,8 x 20,7 cm	3.33 kg
BH36000	7314150178681	1	6000 kg	400 mm	620 mm	25,1 x 28,2 cm	7.4 kg

BH3HD8000**Heavy duty jack stand**

- 8T maximum load capacity
- Safety pin locking system with rubber grip
- 600 mm maximum height achievable
- Special rubber coated round saddle makes load placement easier and secure
- TÜV approved and GS certified
- Sold individually

BH3HD8000	7314150170494	2	8000 kg	385 mm	600 mm	470 mm	430 mm	9.4 kg



BH3HD12000

Heavy duty jack stand

- 12T heavy duty jack stand
- Equipped with a knob bearing system for precise height adjustment
- 510 mm maximum height achievable
- Special rubber coated round saddle makes load placement easier and secure
- TÜV approved and GS certified
- Sold individually

BH3HD12000	7314150170500	1	12000 kg	350 mm	510 mm	362 mm	329 mm	12.38 kg



BH3HD16000

Heavy duty jack stand

- 16T heavy duty jack stand
- Safety pin locking system with rubber grip
- 715 mm maximum height achievable
- Special rubber coated round saddle makes load placement easier and secure
- TÜV approved and GS certified
- Sold individually

BH3HD16000	7314150170524	1	16000 kg	475 mm	715 mm	525 mm	466 mm	18.2 kg



BH3HD20000A

Heavy duty jack stand, 20T

- Specially designed for heavy duty applications
- Reinforced structure for increased safety when supporting loads
- Safety pin locking system with rubber grip
- 1150 mm maximum height achievable
- Special rubberised V-shape saddle for easy and secure loading
- Equipped with two wheels for convenient transport
- TÜV approved and GS certified
- Sold individually

BH3HD20000A	7314150337668	1	20000 kg	825 mm	1150 mm	47,5 x 47,5 cm	38.5 kg



BH5SP500QA

Hydraulic transmission jack single piston 500kg capacity



- Used in pits and beneath elevated vehicles for safely removing, installing or transporting transmissions
- Quick approach system enables reaching the full height in only 38 pump strokes
- Hard chrome plated rod and pump piston
- Large and comfortable pedal for easy lifting from right or left side
- Wide base for high stability during lifting and manoeuvring
- Saddle can be positioned upside down and thanks to the addition of our standard rubber and steel saddles BH11500-04 and BH11500-05 (options), the transmission jack can be used also for lifting car components such as exhaust pipes, fuel tanks, suspension springs or hubs when removing studs
- Sturdy steel swivel castors (75 mm diameter) covered with PU for greater durability and optimal manoeuvrability
- Two castors are equipped with brakes to prevent movement while loading/unloading
- CE certified by Official Independent Technical Inspection Association

BH5SP500QA	7314150270217	1	500 kg	1175 mm	1985 mm	38	66 cm	204x660x660 mm	34.85 kg	

BH5DP1000QA

Hydraulic transmission jack double piston 1000kg capacity



- 1000 kg transmission jack used in pits and beneath elevated vehicles, for safely removing, installing or transporting transmissions
- Quick approach system with double piston enables reaching the full height in only 36 pump strokes
- Hard chrome plated rod and pump piston
- Large and comfortable pedal for easy lifting from right or left side
- Wide base for high stability during lifting and manoeuvring
- Saddle can be positioned upside down and thanks to the addition of our standard rubber and steel saddles BH11500-04 and BH11500-05 (options), the transmission jack can be used also for lifting car components such as exhaust pipes, fuel tanks, suspension springs or hubs when removing studs
- Lowering mechanism with a foot pedal allows the user to keep their hands free for other operations
- Sturdy steel swivel castors (75 mm diameter) covered with PU for greater durability and optimal manoeuvrability
- Two castors are equipped with brakes to prevent movement while loading/unloading
- CE certified according to Directive 2006/42/EC

BH5DP1000QA	7314150270224	1	1000 kg	899 mm	1899 mm	1389 mm	36	75,9 cm	1954x759x759 mm	61 kg

BH5US1000

Universal saddle for transmission jacks



- Universal gyroscopic adjustable saddle with chains for securing the load
- 1000kg maximum load capacity
- Allows swiveling and positioning of the transmission at different angles
- Adjustable angle -6° to 12°
- Heavy duty solid mounting plates
- Fits on transmission jacks ref. BH5SP500QA and BH5DP1000QA

BH5US1000	7314150243174	1	260-510 mm	420 mm	340 mm	250 mm	18.1 kg	



BH6FC1000
Foldable crane 1T

- Used to lift and support a wide range of heavy vehicle parts, such as engines, transmissions, etc.
- 4 fixed positions of the lifting arm: 1,000, 750, 500 and 250 kg
- High flexibility and broad application area:
- Minimum entry height: 88 mm
- Maximum hook height: 2175 mm
- Foldable legs enable compact storage of the crane when not in use
- Dual piston system decreases the number of necessary strokes by 50%
- Steel and nylon wheels ensure both excellent durability and silent handling
- Swivelling PU pump lever for easy and comfortable pumping from any direction
- Increased safety due to the “dead man” safety mechanism, overload valve, swivel safety hook, etc.
- CE certified by Official Independent Technical Inspection Association

BH6FC1000	7314150178650	1	1000 kg	750 kg	500 kg	250 kg	88 mm	+/- 45	1480 mm	1030 mm	2175 mm	85 kg



BH6FC2000
Foldable crane, 2T

- Used to lift and support a wide range of heavy vehicle parts, such as engines, transmission boxes, etc.
- 4 fixed positions of the lifting arm: 2,000, 1,500, 1,000 and 500 kg
- High flexibility and broad application area:
- Minimum entry height: 130 mm
- Maximum hook height: 2640 mm
- Foldable legs enable compact storage of the crane when not in use
- Dual piston system decreases the number of necessary strokes by 50%
- Heavy duty steel castors ensure excellent durability
- Swivelling PU pump lever for easy and comfortable pumping from any direction
- Increased safety due to the “dead man” safety mechanism, overload valve, swivel safety hook, etc.
- CE certified by Official Independent Technical Inspection Association

BH6FC2000	7314150234639	1	2000 kg	1500 kg	1000 kg	500 kg	130 mm	+/- 75	1845 mm	1220 mm	2640 mm	170 kg



BH6AC1-680A
Engine hoist load balancer

- For easily lifting and balancing of engines or suspended loads with an offset centre of gravity
- 680 kg maximum load capacity
- Balance point adjustable by foldable handle, 190 mm either side of centre
- 640 mm length for easy attachment of larger engines
- Heavy duty welded chain (Ø7.5 mm) and solid mounting plates
- Suitable accessory for our range of cranes: BH6FC1000, BH6FC2000 and BH6PC600
- CE certified by Official Independent Technical Inspection Association

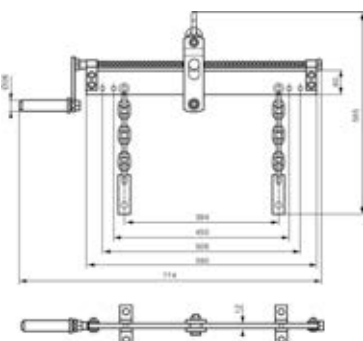

			A	B			
BH6AC1-680A	7314150433544	1	774 mm	195 mm	680 kg	565x12x774 mm	7.6 kg

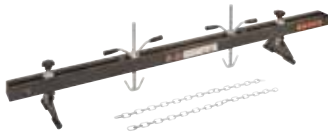

BH8AC1-500

Engine support bar

- Used to easily lift and move engines out of the engine bay
- 500kg maximum load capacity
- Adjustable width up to 1800 mm enables a wide range of use
- Tilting mechanism to allow easy transfer of centre of gravity
- Heavy duty construction for safe operation
- Suitable for all cars, including large SUVs
- Features two adjustable heavy duty hooks for chain mounting

BH8AC1-500	7314150170463	1	150 x 165 x 1800 mm	1800 mm	500 kg	20.71 kg



BH1CD680

Car dolly for vehicle manoeuvring

- Used to effortlessly lift and manoeuvre locked, blocked or disabled passenger or light commercial vehicles around a workshop, a showroom, a car park, an exhibition hall or in a tight space
- By stepping on the foot pedal, the ratcheting system squeezes the wheel of the vehicle between the two rollers and lifts it up in seconds
- Rollers made from sturdy plastic to prevent damage during lifting and moving
- Maximum load capacity per car dolly: 680 kg
- Equipped with a handle covered with PVC, providing comfort when transporting the car dolly
- 4 nylon multi-directional bearing swivel castors for effortless vehicle mobility and direction changes
- Rear castors are equipped with a braking system for safely locking the vehicle in position
- Maximum tire width: 325 mm
- Min./max. tire diameter: 450/810 mm
- Four units are required for moving a vehicle
- Sold individually
- CE certified by Official Independent Technical Inspection Association

BH1CD680	7314150330379	1	610 x 240 x 220 mm	16.22 kg

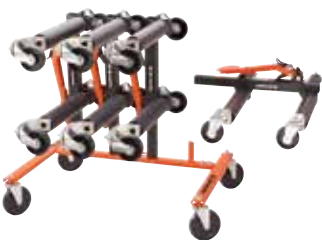

BH1CD680ST

Storage rack for car dollies

- Storage rack for up to 4 car dollies when not in use
- It enables you to store and roll the car dollies where you need them or out of the way for storage in seconds
- 4 nylon multi-directional swivel castors for easy and comfortable transport
- Rear castors are equipped with a braking system for safely locking this device into position
- Maximum load capacity: 135 kg

BH1CD680ST	7314150330386	1	715 x 130 x 155 mm	135 kg	11.044 kg



BH8AC3-600

Hydraulic wheel dolly 600kg capacity

- Hydraulic wheel dolly for helping users with tyre changing and maintenance
- Capable of lifting wheels up to 600kg weight
- Dolly wheel system allows tyre tilt to be changed up to 4.1 degrees, matching the vehicle's wheel angle
- Handle or foot pedal systems for wheel lifting
- Perfect balance between quick lift and accurate approach
- Equipped with a powerful hydraulic ram able to reach the maximum height in 40 pedal strokes
- Five position adjustable mechanical system allows fitting a wide range of tyre diameters, from 300 mm to 1300 mm
- Steel rollers allow the tyre to turn by itself to match the vehicle bolt positions
- Safety features
 - Foot pedal release, equipped with "dead man" safety feature
 - Foot stopper to ensure the safety of the user
 - Rear castors are equipped with a brake to secure the wheel dolly and prevent movement during tyre changing
- Steel rollers to allow the tire to turn so it is aligned with the vehicle bolt position
- Easy wheel transport thanks to the handles and four castors
- CE certified according to Directive 2006/42/EC

BH8AC3-600	7314150351893	1	600 kg	X	300-1300 mm	535 mm	45 mm	530 mm	1030x1050x1020 mm	93.5 kg



BH8AC3-1500A

Hydraulic wheel dolly, 1.5T

- Hydraulic wheel dolly for heavy agricultural and contractor equipment
- Able to lift wheels up to 1500 kg weight
- For easily mounting and dismounting wheels from 1.0 m to 2.2 m diameter
- Eight heavy duty bearing rollers and two wheel holding bars for easier wheel rotation when aligning bolt holes to studs
- Double-acting hydraulic pump provides safe and controlled wheel lifting and lowering
- Easy wheel transport thanks to the 4 steel castors covered by a 150 mm diameter PU belt
- Castors equipped with a braking system for easy and safe manoeuvring and storage
- CE certified according to Directive 2006/42/EC

BH8AC3-1500A	7314150516391	1	1500 kg	N/A	1000-2200 mm	- mm	- mm	250 - 804,5 mm	310x1070x 1345 mm	132 kg



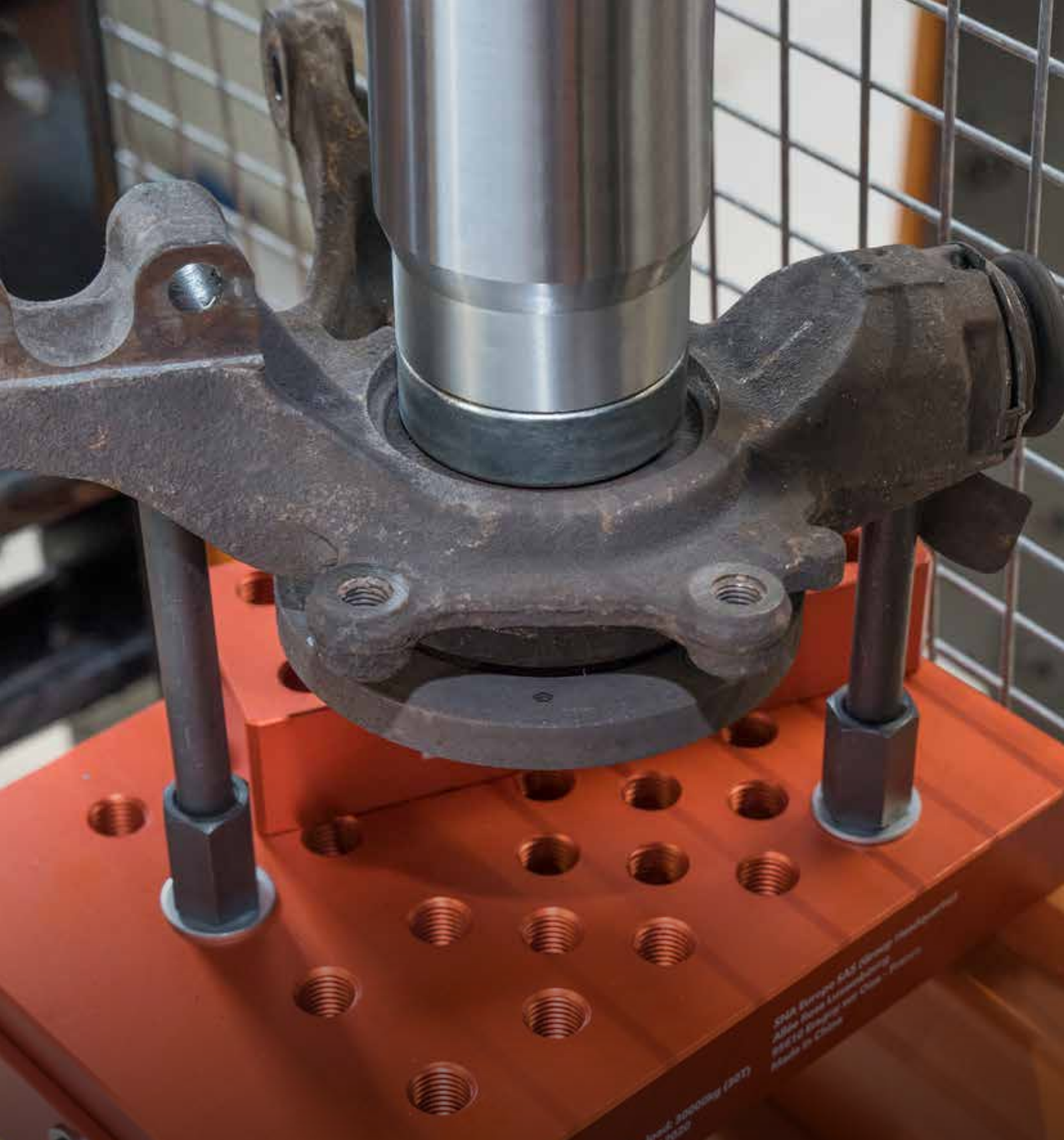

WORKSHOP EQUIPMENT



BAHCO

BH715

Bench Press, 15T



- Heavy duty construction with rounded shapes and exclusive design
- Large pressure gauge filled with glycerine for easy reading at convenient eye level
- Hard chrome plated slide and piston
- Rulers to facilitate centring the piston on the part to be extracted or inserted
- Two V-blocks included, usable on V or flat side as needed
- Auto-centring pins for the table
- Double speed pump with built-in safety overload valve
- Pressing punch set with six punch pins and a punch plate included
- Insulated handles
- Tool tray at the bottom
- Quick approach feature using the handle
- CE certified according to 2006/42/EC

				A	B	C	D	E	F1	F2	F	G	H	I	J	K	L	M	N	
BH715	7314150237555	1	15.000 kg	695 mm	500 mm	883 mm	970 mm	495 mm	99 mm	399 mm	117 mm	8 mm	136 mm	158 mm	595 mm	714 mm	50 mm	167 mm	8 mm	80 kg

BH720/BH730/BH750

Press, 20T, 30T and 50T

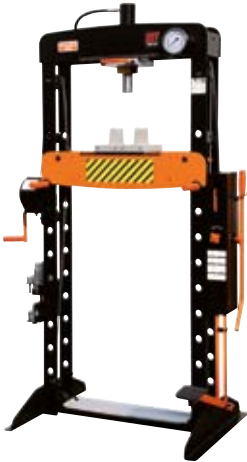

- 20T, 30T and 50T workshop presses
- Heavy duty construction with rounded shapes and exclusive design
- Large pressure gauge filled with glycerine for easy reading at convenient eye level
- Hard chrome plated slide and piston
- Quick approach feature using the pedal or the handle
- Rulers to facilitate centring the piston on the item to be extracted
- Two V-blocks included, usable on V or flat side as needed
- Auto-centring pins for the table
- Easy raising and lowering of the press table thanks to the winch with swivel handle
- Pedal with anti-slip rubber pad
- Pressing punch set with eight pins and a punch plate included
- Insulated handles
- Tool tray at the bottom
- CE certified by Official Independent Technical Inspection Association

				A	B	C	D	E	F1	F2	F	G	H	L	M	R	X	Y	
BH720	7314150235650	1	20.000 kg	880 mm	650 mm	1785 mm	1885 mm	645 mm	43 mm	1143 mm	129 mm	8 mm	165 mm	70 mm	211 mm	183 mm	785 mm	920 mm	151 kg
BH730	7314150235667	1	30.000 kg	960 mm	700 mm	1776 mm	1810 mm	695 mm	140 mm	1020 mm	137 mm	10 mm	200 mm	80 mm	195 mm	148 mm	855 mm	990 mm	189 kg
BH750	7314150235674	1	50.000 kg	1000 mm	770 mm	1832 mm	1855 mm	725 mm	173 mm	1013 mm	204 mm	12 mm	243 mm	90 mm	280 mm	198 mm	905 mm	1070 mm	309 kg

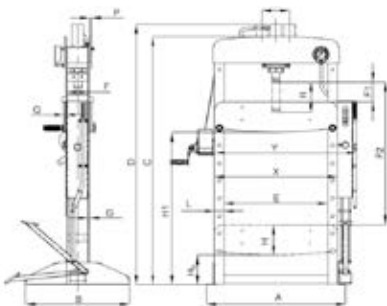

	H1/mm	H2/mm	H3/mm	H4/mm	H5/mm	H6/mm	H7/mm	H8/mm	H9/mm	H10/mm	H11/mm	H12/mm
BH720	1288 ⁺⁵	1178 ⁺⁵	1068 ⁺⁵	998 ⁺⁵	848 ⁺⁵	738 ⁺⁵	628 ⁺⁵	518 ⁺⁵	408 ⁺⁵	298 ⁺⁵	188 ⁺⁵	164.5 ⁺⁵
BH730	1108 ⁺⁵	998 ⁺⁵	888 ⁺⁵	778 ⁺⁵	668 ⁺⁵	558 ⁺⁵	448 ⁺⁵	338 ⁺⁵	228 ⁺⁵	/	/	199.5 ⁺⁵
BH750	1012 ⁺⁵	872 ⁺⁵	732 ⁺⁵	592 ⁺⁵	452 ⁺⁵	312 ⁺⁵	172 ⁺⁵	/	/	/	/	242.5 ⁺⁵



BH7100A
Hydro-pneumatic press 100T



- Double speed hydro-pneumatic pump controlled by pedal with built-in safety overload valve
- Sturdy welded frame with exclusive rounded shapes design
- Large pressure gauge with glycerine for easy reading at convenient eye level
- Slide and piston chrome plated
- Easy raising and lowering of the press table thanks to the winch with swivel handle
- Rulers to facilitate centring the piston on the item to be extracted
- Two V-blocks with handles included, usable on V or flat side depending as needed
- Auto-centring table pins incorporating "butterfly" locks to keep them engaged for greater safety
- All handles insulated
- Pressing pin set with 8 pins and a punch plate included.
- Tool tray at the bottom
- Working pressure: 7.5-8.5 bar 0.75-0.85 MPa Air connection: 1/4" NPT
- CE certified by Official Independent Technical Inspection Association

				BAR		A B C D E F1 F2 F G H L M R X Y	
BH7100A	7314150345908	1	100000 kg	7.5 - 8.5 bar	1/4" in	1 mm 1193 mm 940 mm 1830 mm 1865 mm 787 mm 85 mm 785 mm 268 mm 16 mm 325 mm 143 mm 250 mm 300 mm 1073 mm 1210 mm 674 kg	

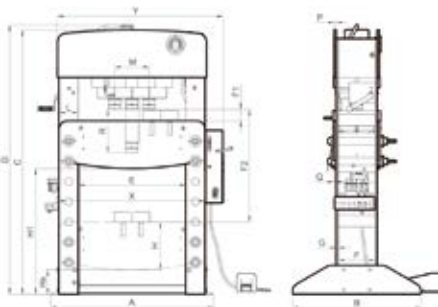

BH7PS30
Universal press supports 30T



- For removing/installing wheel bearings, hubs, bushings, etc. easily and safely
- 30T maximum load capacity
- Suitable for our presses BH715, BH720, BH730 and BH750
- Lateral safety retaining plates prevent slippage and accidental movement
- Five steel adjustment spindles and spacer block for precise support and versatility
- Block dimensions: 275 x 200 mm, 40 mm thick
- Blocks and lateral plates made of aluminium, weighing only 8.2 kg (including adjustment spindles)

BH7PS30	7314150474882	2	225 x 100 x 275 mm	30000 kg	275 x 200 mm 8.6 kg

BH7_SG
Safety grids for presses 20, 30 and 50T

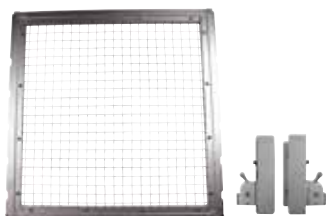

- Protects user against flying parts if the components break or jump during pressing
- Easy to install with only 4 screws
- Easily adjustable vertically by just sliding the guard on the lateral guides
- Made of aluminium
- Suitable for our BH720, BH730 and BH750 workshop presses

BH720SG	7314150238477	1	530 mm	20 mm	2.93 kg
BH730SG	7314150238484	1	590 mm	20 mm	3.15 kg
BH750SG	7314150238491	1	625 mm	20 mm	3.4 kg



BH7100SG
Safety grid for press 100T

- Protects user against flying parts if the components break or jump during pressing
- Easy to install with only 4 screws
- Easily adjustable vertically by just sliding the guard on the lateral guides
- Frame made of aluminium
- Guard made of sturdy polycarbonate

BH7100SG	7314150299782	1	200 x 730 x 775 mm	5.54 kg



BUCPE
Exhaust fume extractor

- Used to discharge fumes outside the workshop
- Foldable for easy and compact storage
- Pressure range: 5 - 8 bar
- Recommended air supply: 190 l/min
- Adjustable tube height to match many different vehicles
- Body made of aluminium for lightness and sturdiness
- Equipped with large rubber wheels and comfortable handle
- Hose extensions (BUCPE3SH and BUCPE3SDH) are available as options

							BAR	
BUCPE	7314150243259	1	300 mm	306 mm	1263 mm	5 - 8 bar	10.74 kg	



BUCPE3SH
Tube extension for BUCPE

- Exhaust hose extension for BUCPE
- Suitable for single exhaust system
- The desired number of individual products can be connected between them
- Made of nylon
- Hose length: 3 m
- Hose diameter: 63.5 mm
- Hose thickness: 0.35 mm

BUCPE3SH	7314150243471	1	3000 mm	63,5 mm	220 mm	530 mm	298 mm	2.0 kg



BUCPE3SDH
A dual exhaust pipe for BUCPE

- Suitable for dual exhaust system
- Made of nylon
- Hose length: 3 m
- Hose diameter: 63.5 mm
- Hose thickness: 0.35 mm
- To be used with BAHCO ref. BUCPE

BUCPE3SDH	7314153024183	1	420 x 530 x 3000 mm	3000 mm	3.88 kg

BLBT100

Dual laser headlamp tester



- Suitable for checking a very wide range of headlamps (high, low and fog lights), such as halogen, xenon, LED and matrix LED for Audi
- With the proper adjustment protocols and additional equipment, it is also suitable for headlamp adjustment according to vehicle manufacturer specifications
- Very lightweight device for very easy handling
- Suitable for use both in garages and in test lanes
- For light and heavy duty vehicles
- Internal adjustable measuring screen with scale for both right- and left-hand drive vehicles
- Laser alignment visor and central laser pointer for easy positioning of the unit in front of the vehicle
- Digital luxometer
- Height adjustment system with locking system from 240 mm to 1,400 mm
- Rotating mast allows a 360° turning of the headlamp tester unit
- Water scale level and knob to compensate/adjust for floor slope
- Base with 3 castors that makes rolling very easy
- High stability and allows locking of the rotating mast
- Convenient use due to positioning of the wheels. Sturdy anti-tip base
- Supplied with assembly, operation and calibration manuals
- CE certified and approved by UTAC and NFR63-801 in France
- Optional rail: BLBT100AC1

BLBT100	7314150179015	1	240-1400 mm	565 mm	500 mm	1650 mm	19.5 kg

BH8AC2-500

500 kg geared engine stand



- Designed for easy direct engine maintenance
- Its 500kg maximum load capacity allows supporting a wide range of engines
- A unique 70:1 gear ratio offers an optimal engine operating experience
- The rotation system is actuated by a swivel and retractable rubber-coated handle
- Features an ergonomic handle for better manoeuvrability
- Highly versatile and adjustable four locking pins
- The oil tray collects surplus oil and keep the floor clean
- Rear swivel castors with brakes for user safety
- Convenient metallic tray for holding tools

					A	B	
BH8AC2-500	7314150412532	1	937 x 712 x 813 mm	500 kg	808 mm	1090 mm	43.2 kg

BLE300

Pneumatic stool



- Cushioned adjustable pneumatic workshop stool
- Adjustable height thanks to the pneumatic system, from 435 mm to 555 mm
- Load capacity: 136 kg
- Three easily accessible drawers for storage of tools, parts, accessories or other items
- Equipped with a handy tray to hold tools or parts
- Rotatable, comfortable high density PU foam pad for high durability
- Four 360° PVC swivel castors with 75 mm diameter and 25 mm width

BLE300	7314150227648	1	550 mm	380 mm	380 mm	136 kg	11 kg



BLE301

Low profile creeper

- Extremely low height: 120 mm
- Adjustable headrest with three positions for increased comfort
- Capacity: 136 kg
- High density foam pad for high durability and good comfort
- Hanger at the back for easy storage in the garage
- Four 360° PVC swivel castors with 75 mm diameter and 25 mm width

BLE301	7314150227662	1	1020 mm	590 mm	120 mm	136 kg	10 kg



BLE302

Creeper and stool combo

- Three comfortable working positions: creeper, seat or stool
- Capacity: 136 kg
- Low height: 135 mm
- High density foam pad for high durability and good comfort
- Six 360° PP swivel castors with 60 mm diameter and 10 mm width

BLE302	7314150227679	1	1010 mm	490 mm	135 mm	136 kg	12 kg



BLE304

Creeper and stool set

- Creeper
- Capacity: 116 kg
- Low height: 135 mm
- High density foam pad for high durability and good comfort
- Foam with greater thickness in the head area for increased comfort
- Six 360° PP swivel castors with 60 mm diameter and 10 mm width
- Seat
- Capacity: 100 kg
- Fixed height
- Equipped with two pouches and a tray to hold tools, parts or accessories
- Large high density foam pad for high durability and good comfort
- Four 360° PP swivel castors with 60 mm diameter and 10 mm width

BLE304	7314150249572	1	135 mm	1020 mm	460 mm	116 / 100 kg	11 kg



STORAGE



**1477K6****26" E77 Premium Storage HUB Tool Trolleys with 6 Drawers**

- 6 drawers heavy-duty tool trolley is based on a solid steel dual-walled case construction
- The unique one DAAT-system ensures that only one drawer can be opened at a time avoiding any risk of tilting
- Fully opening drawers with individual shock-protecting corner bumpers
- The pivoting latching system avoids open the drawers unintentionally
- Wheels with dual braking system secure the trolley solidly to the ground, preventing movement in any direction
- Unrivalled customization possibilities thanks to perforated side panels and top specific design
- Xpand accessories modular system available to provide the end-user the option of configuring the perfect workstation
- Ultimate locking system with electronic access control available
- Scratchproof powder coating outside and inside assures a high protection against rust

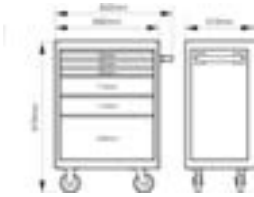

1477K6	7314150350391	1	976 x 510 x 820 mm	1000 kg	6	445 mm	543 mm	45 kg	125 mm	36 mm	81.40 kg	2009					
1477K6BLACK	7314150351091	1	976 x 510 x 820 mm	1000 kg	6	445 mm	543 mm	45 kg	125 mm	36 mm	81.40 kg	9005					
1477K6GREY	7314150351138	1	976 x 510 x 820 mm	1000 kg	6	445 mm	543 mm	45 kg	125 mm	36 mm	81.40 kg	9022					

**1477K7****26" E77 Premium Storage HUB Tool Trolleys with 7 Drawers**

- 7 drawers heavy-duty tool trolley is based on a solid steel dual-walled case construction
- The unique one DAAT-system ensures that only one drawer can be opened at a time avoiding any risk of tilting
- Fully opening drawers with individual shock-protecting corner bumpers
- The pivoting latching system avoids open the drawers unintentionally
- Wheels with dual braking system secure the trolley solidly to the ground, preventing movement in any direction
- Unrivalled customization possibilities thanks to perforated side panels and top specific design
- Xpand accessories modular system available to provide the end-user the option of configuring the perfect workstation
- Ultimate locking system with electronic access control available
- Scratchproof powder coating outside and inside assures a high protection against rust

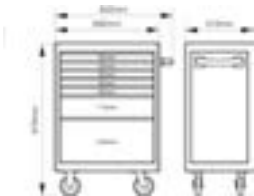

1477K7	7314150350407	1	976 x 510 x 820 mm	1000 kg	7	445 mm	543 mm	45 kg	125 mm	36 mm	84.60 kg	2009					
1477K7BLACK	7314150351107	1	976 x 510 x 820 mm	1000 kg	7	445 mm	543 mm	45 kg	125 mm	36 mm	84.60 kg	9005					
1477K7GREY	7314150351145	1	976 x 510 x 820 mm	1000 kg	7	445 mm	543 mm	45 kg	125 mm	36 mm	84.60 kg	9022					

**1477K8****26" E77 Premium Storage HUB Tool Trolleys with 8 Drawers**

- 8 drawers heavy-duty tool trolley is based on a solid steel dual-walled case construction
- The unique one DAAT-system ensures that only one drawer can be opened at a time avoiding any risk of tilting
- Fully opening drawers with individual shock-protecting corner bumpers
- The pivoting latching system avoids open the drawers unintentionally
- Wheels with dual braking system secure the trolley solidly to the ground, preventing movement in any direction
- Unrivalled customization possibilities thanks to perforated side panels and top specific design
- Xpand accessories modular system available to provide the end-user the option of configuring the perfect workstation
- Ultimate locking system with electronic access control available
- Scratchproof powder coating outside and inside assures a high protection against rust

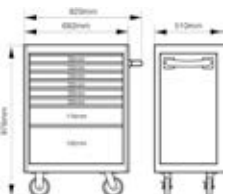

1477K8	7314150350414	1	976 x 510 x 820 mm	1000 kg	8	445 mm	543 mm	45 kg	125 mm	36 mm	85.60 kg	2009					
1477K8BLACK	7314150351114	1	976 x 510 x 820 mm	1000 kg	8	445 mm	543 mm	45 kg	125 mm	36 mm	85.60 kg	9005					
1477K8GREY	7314150351183	1	976 x 510 x 820 mm	1000 kg	8	445 mm	543 mm	45 kg	125 mm	36 mm	85.60 kg	9022					

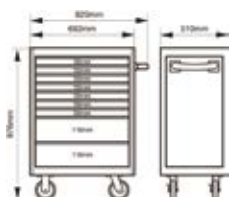
**1477K9****26" E77 Premium Storage HUB Tool Trolleys with 9 Drawers**

- 9 drawers heavy-duty tool trolley is based on a solid steel dual-walled case construction
- The unique one DAAT-system ensures that only one drawer can be opened at a time avoiding any risk of tilting
- Fully opening drawers with individual shock-protecting corner bumpers
- The pivoting latching system avoids open the drawers unintentionally
- Wheels with dual braking system secure the trolley solidly to the ground, preventing movement in any direction
- Unrivalled customization possibilities thanks to perforated side panels and top specific design
- Xpand accessories modular system available to provide the end-user the option of configuring the perfect workstation
- Ultimate locking system with electronic access control available
- Scratchproof powder coating outside and inside assures a high protection against rust

												RAL
1477K9	7314150350940	1	976 x 510 x 820 mm	1000 kg	9	445 mm	543 mm	45 kg	125 mm	36 mm	91 kg	2009
1477K9BLACK	7314150351121	1	976 x 510 x 820 mm	1000 kg	9	445 mm	543 mm	45 kg	125 mm	36 mm	91 kg	9005
1477K9GREY	7314150351190	1	976 x 510 x 820 mm	1000 kg	9	445 mm	543 mm	45 kg	125 mm	36 mm	91 kg	9022

1487K4W**Premium E87 Storage HUB Top Chests on Wheels with 4 Drawers**

- E87 Top chest on wheels with 4 drawers
- 1DAAT system ensures that only one drawer can open at a time
- Fully opening drawers and individual shock-protection corner bumpers for defending against unexpected collisions
- The pivoting latching system avoids unintentional drawer opening
- Wheels with dual braking system secure the trolley solidly to the ground, preventing movement in any direction
- Sturdy steel dual-walled case construction
- Ultimate locking system with electronic access control available
- Xpand modular accessories system available
- Scratchproof powder coating available in orange and black
- Dual-walled case ensures that the drawers still open after collision damage to the outer wall
- Replace the standard composite top with stainless steel, MDF or chestnut to meet the needs of every job
- A wide range of Fit&Go ready-to-use foam inlays with tools are available

												RAL
1487K4W	7314150425181	1	564 x 510 x 692 mm	400 kg	4	543 mm	445 mm	45 kg	125 mm	36 mm	52 kg	2009
1487K4BKW	7314150426133	1	564 x 510 x 692 mm	400 kg	4	543 mm	445 mm	45 kg	125 mm	36 mm	52 kg	9005

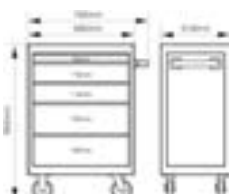
1472K5**26" E72 Storage HUB Tool Trolleys with 5 Drawers**

- 5 drawers heavy-duty tool trolley is based on a solid steel dual-walled case construction
- Fully opening drawers equipped with ball-bearing sliders that glide very smoothly and have a capacity up to 30 kg
- Rubber wheels ensure maximum stability, making the trolley easy to manoeuvre, even on irregular surfaces
- Perforated side panels allow end-user add different Xpand accessories
- Strong and secure round locking system protects the tool trolley against theft
- Scratchproof powder coating outside and inside assures a high protection against rust
- Shock protecting corner bumpers minimise the chance of injuries and damage to surrounding objects
- Dual-walled case ensures that the drawers always open after a collision damages the outside wall
- A wide range of Fit&Go ready-to-use foam inlays with tools is available

												RAL
1472K5	7314150349463	1	952 x 510 x 782 mm	600 kg	5	445 mm	543 mm	30 kg	125 mm	30 mm	65 kg	2009
1472K5BLACK	7314150349500	1	952 x 510 x 782 mm	600 kg	5	445 mm	543 mm	30 kg	125 mm	30 mm	65 kg	9005
1472K5RED	7314150349562	1	952 x 510 x 782 mm	600 kg	5	445 mm	543 mm	30 kg	125 mm	30 mm	65 kg	3001
1472K5BLUE	7314150349616	1	952 x 510 x 782 mm	600 kg	5	445 mm	543 mm	30 kg	125 mm	30 mm	65 kg	5002

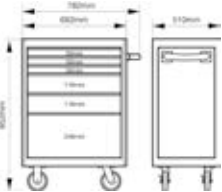
**1472K6****26" E72 Storage HUB Tool Trolleys with 6 Drawers**

- 6 drawers heavy-duty tool trolley is based on a solid steel dual-walled case construction
- Fully opening drawers equipped with ball-bearing sliders that glide very smoothly and have a capacity up to 30 kg
- Rubber wheels ensure maximum stability, making the trolley easy to manoeuvre, even on irregular surfaces
- Perforated side panels allow end-user add different Xpand accessories
- Strong and secure round locking system protects the tool trolley against theft
- Scratchproof powder coating outside and inside assures a high protection against rust
- Shock protecting corner bumpers minimise the chance of injuries and damage to surrounding objects
- Dual-walled case ensures that the drawers always open after a collision damages the outside wall
- A wide range of Fit&Go ready-to-use foam inlays with tools is available

1472K6	7314150349470	1	952 x 510 x 782 mm	600 kg	6	445 mm	543 mm	30 kg	125 mm	30 mm	68 kg	2009			
1472K6BLACK	7314150349531	1	952 x 510 x 782 mm	600 kg	6	445 mm	543 mm	30 kg	125 mm	30 mm	68 kg	9005			
1472K6RED	7314150349579	1	952 x 510 x 782 mm	600 kg	6	445 mm	543 mm	30 kg	125 mm	30 mm	68 kg	3001			
1472K6BLUE	7314150349623	1	952 x 510 x 782 mm	600 kg	6	445 mm	543 mm	30 kg	125 mm	30 mm	68 kg	5002			

1472K7**26" E72 Storage HUB Tool Trolleys with 7 Drawers**

- 7 drawers heavy-duty tool trolley is based on a solid steel dual-walled case construction
- Fully opening drawers equipped with ball-bearing sliders that glide very smoothly and have a capacity up to 30 kg
- Rubber wheels ensure maximum stability, making the trolley easy to manoeuvre, even on irregular surfaces
- Perforated side panels allow end-user add different Xpand accessories
- Strong and secure round locking system protects the tool trolley against theft
- Scratchproof powder coating outside and inside assures a high protection against rust
- Shock protecting corner bumpers minimise the chance of injuries and damage to surrounding objects
- Dual-walled case ensures that the drawers always open after a collision damages the outside wall
- A wide range of Fit&Go ready-to-use foam inlays with tools is available

1472K7	7314150349487	1	952 x 510 x 782 mm	600 kg	7	445 mm	543 mm	30 kg	125 mm	30 mm	71.20 kg	2009			
1472K7BLACK	7314150349548	1	952 x 510 x 782 mm	600 kg	7	445 mm	543 mm	30 kg	125 mm	30 mm	71.20 kg	9005			
1472K7RED	7314150349586	1	952 x 510 x 782 mm	600 kg	7	445 mm	543 mm	30 kg	125 mm	30 mm	71.20 kg	3001			
1472K7BLUE	7314150349630	1	952 x 510 x 782 mm	600 kg	7	445 mm	543 mm	30 kg	125 mm	30 mm	71.20 kg	5002			

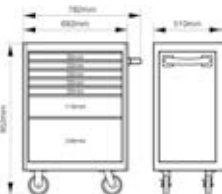
**1472K8****26" E72 Storage HUB Tool Trolleys with 8 Drawers**

- 8 drawers heavy-duty tool trolley is based on a solid steel dual-walled case construction
- Fully opening drawers equipped with ball-bearing sliders that glide very smoothly and have a capacity up to 30 kg
- Rubber wheels ensure maximum stability, making the trolley easy to manoeuvre, even on irregular surfaces
- Perforated side panels allow end-user add different Xpand accessories
- Strong and secure round locking system protects the tool trolley against theft
- Scratchproof powder coating outside and inside assures a high protection against rust
- Shock protecting corner bumpers minimise the chance of injuries and damage to surrounding objects
- Dual-walled case ensures that the drawers always open after a collision damages the outside wall
- A wide range of Fit&Go ready-to-use foam inlays with tools is available

1472K8	7314150349494	1	952 x 510 x 782 mm	600 kg	8	445 mm	543 mm	30 kg	125 mm	30 mm	75.40 kg	2009			
1472K8BLACK	7314150349555	1	952 x 510 x 782 mm	600 kg	8	445 mm	543 mm	30 kg	125 mm	30 mm	75.40 kg	9005			
1472K8RED	7314150349593	1	952 x 510 x 782 mm	600 kg	8	445 mm	543 mm	30 kg	125 mm	30 mm	75.40 kg	3001			
1472K8BLUE	7314150349647	1	952 x 510 x 782 mm	600 kg	8	445 mm	543 mm	30 kg	125 mm	30 mm	75.40 kg	5002			

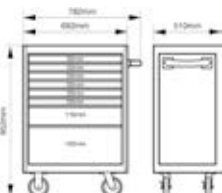



1482K4W

26" E72 Storage HUB Top Chests on Wheels with 4 Drawers

- E82 top chest on wheels with 4 drawers based on a sturdy steel dual-walled case construction
- Fully opening drawers equipped with ball-bearing slides that glide very smoothly and have a capacity up to 30 kg
- Rubber wheels ensure maximum stability, making the trolley easy to manoeuvre, even on irregular surfaces
- Perforated side panels allow users to add various Xpand accessories
- Strong and secure cylindrical locking system protects the tool trolley against theft
- Scratchproof powder coating outside and inside ensures high protection against rust
- Shock protection corner bumpers minimise the risk of injuries and damage to surrounding objects
- Dual-walled case ensures that the drawers still open after collision damage to the outer wall
- Top in stainless steel, MDF or chestnut available to meet the needs of every job
- Foldable handle for easy carrying
- A wide range of Fit&Go ready-to-use foam inlays with tools are available
- Available in orange and black

1482K4W	7314150425174	1	542 x 515 x 699 mm	400 kg	4	543 mm	445 mm	30 kg	125 mm	30 mm	45 kg	2009
1482K4BKW	7314150426126	1	542 x 515 x 699 mm	400 kg	4	543 mm	445 mm	30 kg	125 mm	30 mm	45 kg	9005



1477K-AC24

Pin Code Locking Systems for 1477K Storage HUB Tool Trolleys

- External charger for emergency opening
- Lock has a 10 button keypad and button

1477K-AC24	7314150370429	1	135 mm	62 mm	36 mm	270 g	



1477K-AC25

Mifare Locking Systems for 1477K Storage HUB Tool Trolleys

- Smart Cardlocker lock and supports Mifare based smart cards
- The cabinet lock uses 2XAAA 1.5V batteries
- 1 Master Card and several user cards
- External charger for emergency opening

1477K-AC25	7314150370436	1	135 mm	62 mm	36 mm	270 g	



1477K-ACTP

Composite Bench Tops for 1477K Storage HUB Tool Trolley

- The composite bench top is built-in storage chambers
- A heavy-duty PP structure has been designed to provide strength
- TPR provides a soft-touch finish
- Its work area is resistant to the most common lubricants
- High capacity to absorb impacts

1477K-ACTP	7314150383764	1	550 mm	510 mm	20 mm	2.84 kg



1477K-ACTW

Wooden Top Middle Parts for 1477K & 1487K Storage HUB Tool Trolleys

- Resistant to the most common lubricants
- Its varnish finishing makes this top very resistant to liquids
- The assembly is easy and quick and based in four points
- It has an easy maintenance and long useful life

1477K-ACTW	7314150370467	1	550 mm	510 mm	20 mm	3.97 kg



1472K-ACTW

Chestnut Wood Tops for 1472K & 1482K Storage HUB Tool Trolley

- Excellent shock absorbing ability
- It is also resistant to the most common lubricants
- Its varnish finishing makes this top very resistant to liquids
- The assembly is easy and quick
- It has an easy maintenance and long useful life

1472K-ACTW	7314150393152	1	680 mm	501 mm	30 mm	6.88 kg



1477K-ACTD

MDF Top Middle Parts for 1477K Storage HUB Tool Trolleys

- This MDF top is as strong as the chestnut wood top
- It is more uniform than natural woods
- Surface is excellent as a workplace.

1477K-ACTD	7314150370474	1	20 mm	550 mm	510 mm	8.8 kg



1477K-ACTSS

Stainless Steel Top Middle Parts for 1477K & 1487K Storage HUB Tool Trolleys

- The stainless steel top is ideal for sterile environments
- The inside is made of MDF
- The assembly is easy and quick and based in four points
- Ideal for highly corrosive environments

1477K-ACTSS	7314150370450	1	550 mm	510 mm	20 mm	12.89 kg

**1472K-ACTD****MDF Tops for 1472K & 1482K Storage HUB Tool Trolley**

- This MDF top is as strong as the chestnut wood top
- One of its main advantages is that it doesn't contain knots or rings
- It is more uniform than natural woods
- Its surface is excellent as a workplace

1472K-ACTD	7314150399345	1	682 mm	501 mm	30 mm	7.4 kg

**1472K-ACTSS****Stainless Steel Tops for 1472K & 1482K Storage HUB Tool Trolley**

- The stainless steel top is ideal for sterile environments
- The inside is made of MDF
- It's perfect for absorbing shocks
- The assembly is easy and quick and based in four points
- Ideal for highly corrosive environments

1472K-ACTSS	7314150399338	1	682 mm	501 mm	30 mm	11.6 kg

**1477K-AC10****Bottom Drawers for 1477K Storage HUB Tool Trolleys**

- Create extra storage capacity for the STORAGE HUB E77 PREMIUM with this bottom drawer
- Ideal for your robust tools
- The plastic drawer can carry up to 20 kg, is easy to install and is supplied with stainless steel sliders and screws

1477K-AC10	7314150353163	1	495 mm	110 mm	390 mm	2.31 kg

**1477K-AC11****Solid Claw and Ring Mountings for 1477K Storage HUB Tool Trolleys**

- All the top accessories can be mounted with a strong claw and adjustable ring
- The unique, patented and functional claw lets you attach all your accessories to the trolley in an instant

1477K-AC11	7314150369874	1	30 mm	68 mm	39 mm	60 g

**1477K-AC12****Top Tool Panels for 1477K Storage HUB Tool Trolleys**

- This panel adds storage capacity on top of your trolley using the existing Bahco hooking system
- Made of steel and coated in a neutral black colour

1477K-AC12	7314150369195	1	396 mm	610 mm	25 mm	1800 g

**1477K-AC13****Top Side Tool Panels for 1477K Storage HUB Tool Trolleys**

- The top side tool panel provides extra storage for your small tools on the top of your Storage HUB
- Use the panel in combination with the Bahco hooking system in different positions
- Manufactured from steel and coated in a neutral black colour

1477K-AC13	7314150369218	1	400 mm	365 mm	25 mm		1160 g

**1477K-AC14****Work Document Boards for 1477K Storage HUB Tool Trolleys**

- Thanks to this document board you will always find pen and paper in the right place
- It's height-adjustable, can tilt up to 90 degrees and rotate through 360 degrees
- The holder is supplied with four magnets
- Manufactured from steel and coated in a neutral black colour

1477K-AC14	7314150369225	1	327 mm	240 mm	25 mm		770 g

**1477K-AC15****Laptop Boards for 1477K Storage HUB Tool Trolleys**

- The flexible laptop board can tilt up to 90 degrees and rotate through 360 degrees
- The curved flaps prevent your laptop from falling
- Made from steel and coated in a neutral black colour

1477K-AC15	7314150369249	1	80 mm	424 mm	298 mm		1440 g

**1477K-AC16****Windshield Supports for 1477K Storage HUB Tool Trolleys**

- This pack of four supports is ideal for supporting large objects like a car window
- The solid supports have a round base and the shape moulds to any object
- You can also set the height easily with an extra pack of adaptive supports
- Made of steel and coated in a neutral black colour

1477K-AC16	7314150369256	1	106 mm	208 mm	115 mm		1630 g

**1477K-AC17****Jacket Holders for 1477K Storage HUB Tool Trolleys**

- The jacquet holder is completely height-adjustable to your needs
- Made of steel and coated in a neutral black colour

1477K-AC17	7314150369270	1	68 mm	435 mm	65 mm		280 g

**1477K-AC18****Roll Holders for 1477K and 1472K Storage HUB Tool Trolleys**

- A clean workshop begins with this roll holder
- Eye-catching orange serrated teeth let you tear off paper with one hand
- Made of steel and coated in a neutral black and orange colour

1477K-AC18	7314150369287	1	33 mm	313 mm	265 mm	960 g

**1477K-AC19****Document Holders for 1477K and 1472K Storage HUB Tool Trolleys**

- This document holder ensures that you have all your important documents at
- Made of steel and coated in a neutral black colour

1477K-AC19	7314150369676	1	241 mm	300 mm	65 mm	1160 g

**1477K-AC20****Spray Canister Holders for 1477K and 1472K Storage HUB Tool Trolleys**

- This spray canister holder can accommodate any type of bottle or canister
- Made of steel and coated in a neutral black colour

1477K-AC20	7314150369683	1	125 mm	307 mm	105 mm	900 g

**1477K-AC21****Power Tool Holders for 1477K and 1472K Storage HUB Tool Trolleys**

- This holder is designed to accommodate most power tools, keeping them out of the way yet in easy access
- Balcony and pins designed for storing impact sockets
- Manufactured from steel and coated in a neutral black colour

1477K-AC21	7314150370412	1	115 mm	302 mm	175 mm	940 g



1477K-AC22

Side Tool Panels for 1477K and 1472K Storage HUB Tool Trolleys

- This panel adds extra storage capacity to both sides of your trolley using the existing Bahco hooking system
- Made of steel and coated in a neutral black colour

1477K-AC22	7314150369706	1	659 mm	300 mm	18 mm		1320 g



1477K-AC28

Removable Long Guiding Poles for 1477K Storage HUB Tool Trolleys

- Form the basis for the Bahco Xpand accessories which you can attach on the top of the Storage HUB E77 PREMIUM and Top Chest
- The guiding poles are coated in a neutral black colour

1477K-AC28	7314150370481	1	455 mm	25 mm	25 mm		430 g



1477K-AC29

Removable Short Guiding Poles for 1477K Storage HUB Tool Trolleys

- The removable metal poles form the basis for the Bahco Xpand accessories which you can attach on the top of the Storage HUB E77 PREMIUM and Top Chest
- The guiding poles are coated in a neutral black colour

1477K-AC29	7314150370498	1	130 mm	25 mm	25 mm		180 g

**1495WB15TSBT****Heavy Duty Steel Top Workbenches & Bottom Tray with 4 Legs - 1500 mm**

- Heavy duty workbench
- Includes bottom tray
- 40 mm thickness steel top is a perfect workplace
- A comprehensive range of accessories (drawers, bottom trays, tool panels, etc.) make these hardworking benches ideal for every situation and provide more storage capacity
- The H-shape welded legs bring strength and robustness to whole workbench
- The legs are flat for greater stability and have anti-slip vulcanized rubber for safety
- Holes are provided for bolting the workbench to the floor
- Very easy assembly
- Load capacity: 1.5 T

1495WB15TSBT	7314150407651	1	1030 x 750 x 1500 mm	65 kg

**1495WB18TSBT****Heavy Duty Steel Top Workbenches & Bottom Tray with 4 Legs - 1800 mm**

- Heavy duty workbench (max. load capacity 1,500 kg)
- Bottom tray included
- 40 mm thickness steel top is a perfect workplace
- The H-shape welded legs bring strength and robustness to whole workbench
- The legs are flat for greater stability and have anti-slip vulcanized rubber for safety
- Holes are provided for bolting the workbench to the floor
- Very easy assembly

1495WB18TSBT	7314150407637	1	1030 x 750 x 1800 mm	73 kg

**1495WB-TW****Heavy Duty Chestnut Top Workbenches with 4-Leg**

- Heavy duty construction workbench (Max. Load Capacity = 1.500kg)
- 40 mm chestnut MDF top is a perfect workplace
- A comprehensive range of accessories (drawers, bottom trays, tool panels, etc) make these hardworking benches perfect for every situation providing more storage capacity
- The H shape welded feet bring strength and robustness to whole workbench
- The feet have a flat shape for higher stability and include anti slippery vulcanized rubber for safety
- Holes are available in case the User wants to screw the workbench to the floor
- Really easy assembly

1495WB15TW	7314150296538	1	1500 mm	750 mm	1030 mm	1500 kg	45.60 kg
1495WB18TW	7314150296569	1	1800 mm	750 mm	1030 mm	1500 kg	51.80 kg

**1495WB-AC****Drawers with Trays or Dividers for 1495WB Workbenches**

- 2 different drawer dimensions
- Tray included in the largest model
- Dividers included in the smallest model

1495WB-AC1	7314150296576	1	500 mm	500 mm	105 mm	15 kg	6.610 kg

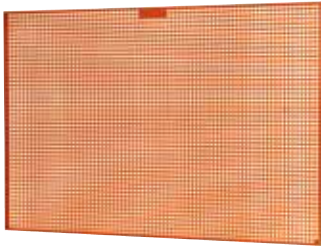

1495TP

Heavy Duty Tool Panels with Reinforced Frame

- Heavy-duty panel with a reinforced frame
- Square 10 mm x 10 mm pattern provides flexible hook layout
- Wide assortment of hooks available
- Adaptors for assembling to workbenches available (1495TP-AC1)
- Dimensions: 600 mm x 25 mm x 500 mm, 1200 mm x 25 mm x 800 mm, 1500 mm x 25 mm x 800 mm, 1800 mm x 25 mm x 800 mm

								RAL
1495TP15	7314150297009	1	1500 mm	25 mm	800 mm	7.8 kg	2009	
1495TP18	7314150297016	1	1800 mm	25 mm	800 mm	11.20 kg	2009	



1495TP-AC1

Tool Panel Adaptors for Wooden and MDF Workbench Tops

- Tool panel and workbench adaptors
- Used for attaching the tool panels to workbenches with wooden or MDF tops
- Suitable for use with the 1495TP wheeled tool panels

1495TP-AC1	7314150297030	1	840 mm	250 mm	100 mm	9.5 kg		

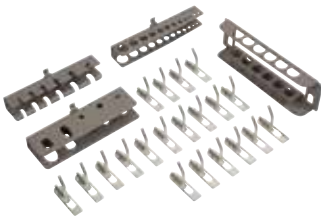

1495CD-AC1

Hook Kit for 1495 Cabinet and Panel - 24 Pcs

- Includes 24 different hooks, a good base for majority of users
- Available for all cabinets and panels

1495CD-AC1	7314150296965	1				1.22 kg		

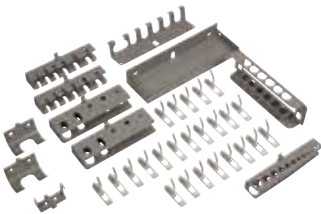

1495CS-AC1

Hook Kit for 1495 Cabinet and Panel - 35 Pcs

- Includes 35 different hooks, a good base for majority of users
- Available for all cabinets and panels
- Suitable for use with the 1495 cabinet and panel

1495CS-AC1	7314150296910	1				2.11 kg		



1495CS1

Wall or Bench Mount Cabinet with Shutter

- Tool cabinet with shutter, compact heavy-duty structure
- Steel structure with square hole panel 1 mm thick
- A professional way to store a lot of tools in a limited amount of space
- All of your tools are immediately visible and right at your fingertips
- Spring rolling system and 2 handles for easier shutter opening/closing
- Panel with square 10 mm x 10 mm pattern providing more flexibility for hooks
- Specific holes for hanging on the wall and/or assembling on a workbench for safety
- Depth of 170 mm is spacious but compact
- Round lock system with 2 keys included
- Wide assortment of hooks available
- Two sizes available
- Different colors available

1495CS15	7314150296934	1	60 kg	900 mm	1500 mm	170 mm			34.20 kg
1495CS18	7314150296941	1	60 kg	900 mm	1800 mm	170 mm			39.60 kg



1495KCWB18TS

Heavy Duty Steel Top Workbenches with Side Drawer Tower and 2-Leg 1800 mm x 750 mm x 1030 mm

- Heavy duty workbench
- 1800 x 750 x 40 mm steel working surface
- The uniformly distributed load (UDL) is 1800 kg for each standard workbench
- The drawer tower can be assembly in any of the sides
- Drawer tower available in 6-7-8 drawers
- Easy assembly. Instructions included

1495K6CWB18TS	7314150369355	1	1030 x 750 x 1800 mm	6	1500 kg	540 mm	440 mm	50/115/246 mm	30 kg	120 kg
1495K7CWB18TS	7314150369362	1	1030 x 750 x 1800 mm	7	1500 kg	540 mm	440 mm	50/115/246 mm	30 kg	123 kg
1495K8CWB18TS	7314150370061	1	1030 x 750 x 1800 mm	8	1500 kg	540 mm	440 mm	50/115/246 mm	30 kg	130.40 kg



1495KCWB18TW

Heavy Duty Wooden Top Workbenches with Side Drawer Tower and 2-Leg 1800 mm x 750 mm x 1030 mm

- Heavy duty workbench
- 1800 x 750 x 40 mm chestnut working surface
- The uniformly distributed load (UDL) is 1800 kg for each standard workbench
- The drawer tower can be assembly in any of the sides
- Drawer tower available in 6-7-8 drawers
- Easy assembly. Instructions included

1495K6CWB18TW	7314150369393	1	1030 x 750 x 1800 mm	1500 kg	6	540 mm	440 mm	50/115/246 mm	30 kg	117.80 kg
1495K7CWB18TW	7314150369409	1	1030 x 750 x 1800 mm	1500 kg	7	540 mm	440 mm	50/115/246 mm	30 kg	120.80 kg
1495K8CWB18TW	7314150369416	1	1030 x 750 x 1800 mm	1500 kg	8	540 mm	440 mm	50/115/246 mm	30 kg	128.20 kg

**BLE305****Pneumatic Stool**

- Cushioned adjustable pneumatic workshop stool
- Adjustable height thanks to the pneumatic system, from 635 mm to 755 mm
- Load capacity: 136 kg
- Rotatable, comfortable and durable Ø355 mm padded seat
- Vinyl covered seat for high durability
- Large, comfortable foot rest

BLE305	7314150339341	1	430 mm	410 mm	430 mm	430 mm	136 kg	6 kg

**1495CD60****2-Door Wall Mount Tool Cabinets**

- Tool cabinet with two doors
- Doors open 180° for complete accessibility
- Round lock system with 2 keys included
- Can be hung from wall or placed on the trolley
- Metal panels 1 mm & 2 mm thick
- Built-in practical fully opening drawer 525 mm x 200 mm x 65 mm
- Panel with square 10 mm x 10 mm pattern in front and sides providing flexibility for hook layout
- Compact structure and highly robust

1495CD60	7314150296927	1	240 kg	900 mm	602 mm	250 mm	21 kg	

**1495CD60W****2-Door Wheeled Tool Cabinets**

- Tool cabinet with heavy-duty structure assembly on a reinforced roll cart
- Doors open 180° for complete accessibility
- Round lock system with 2 keys included
- Can be hung from wall or placed on the trolley
- Metal panels 1 mm & 2 mm thick
- 4 Swivelling wheels (2 with brakes) and outside handle makes transport easy and safe
- 2 Shelves provide storage capacity for bulky parts, 180° doors opening for full access to the inside
- Built-in practical fully opening drawer 525 mm x 200 mm x 65 mm
- Panel with square 10 mm x 10 mm pattern in front and sides providing flexibility for hook layout
- Compact structure and highly robust
- Wide assortment of hooks available

1495CD60W	7314150303656	1	240 kg	1605 mm	625 mm	450 mm	100 mm	43.40 kg	



1470KC2
Two Tray Steel Roll Carts

- Steel U shape structure
- Wheels of 25 x 100 mm with ball bearings and non-marking TPR on the surface
- Internal dimensions of the trays: 750 x 425 x 77 mm
- Designed and manufactured for quick and easy assembly
- Large capacity trays for storing both small and bulky objects
- Colour: orange
- Strong steel frame construction

1470KC2	7314150226696	1	1051 x 435 x 764 mm	100 kg	2	77 mm	420 mm	750 mm	50 kg	100 mm	25 mm	16.40 kg



1470KC3A
Three Tray Steel Roll Carts

- Steel U shape structure
- Wheels of 25 x 100 mm with ball bearings and non-marking TPR on the surface
- Internal dimensions of the trays: 750 x 425 x 77 mm
- Designed and manufactured for quick and easy assembly
- Large capacity trays for storing both small and bulky objects
- Colour: orange
- Strong steel frame construction

1470KC3A	7314150506354	1	1051 x 435 x 764 mm	150 kg	3	77 mm	420 mm	750 mm	50 kg	100 mm	25 mm	21.4 kg



834V
Heavy Duty Square Guide Bench Vices with Interchangeable Jaws



- Heavy-duty square guide bench vice
- Made of high-grade cast steel
- Interchangeable surface-hardened jaws
- Hardened pipe-gripping jaws and adjustable guide by centrally located screw
- Laminated spindle thread for smooth operation
- Forged and chrome plated spindle with safety rubber rings
- Oversized polished anvil
- Spare jaws and spindle 6072M and 6070H
- Standards: UNE 16598

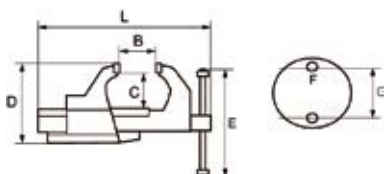

				B	C	D	E	F	G	L	
834V-4	7311518286811	1	100 mm	145 mm	63 mm	122 mm	240 mm	11 mm	90 mm	325 mm	5500 g
834V-5	7311518286828	1	125 mm	170 mm	76 mm	152.5 mm	275 mm	13 mm	115 mm	402 mm	12400 g
834V-6	7311518286835	1	150 mm	230 mm	94 mm	182 mm	310 mm	13 mm	145 mm	492 mm	19000 g
834V-7	7311518286842	1	175 mm	250 mm	112 mm	211 mm	340 mm	17 mm	165 mm	551 mm	29400 g

Slide adjustment screw to regulate the looseness with pipe holding jaws

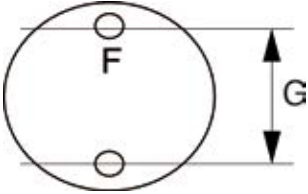

833SB

Swivel Bases for 6010/6072 and 834V Bench Vices

- For 6010, 6072 and 834V bench vices
- Made of high-grade cast steel
- More versatility for Bahco 6010, 6072 and 834V vices by enabling them to be rotated

						F	G	
833SB-4	7311518286859	1	360°	80 mm	100 mm	11 mm	90 mm	850 g
833SB-5	7311518286866	1	360°	100 mm	125 mm	13 mm	115 mm	1150 g
833SB-6	7311518286873	1	360°	125 mm	150 mm	13 mm	145 mm	1500 g
833SB-7	7311518286880	1	360°	150 mm	175 mm	17 mm	165 mm	2500 g

BMD150

Round magnetic dish



- Used to store bolts, nuts and tools, for example in the repair shop
- Featuring a magnetic base with rubber protection so that the dish can be attached to any magnetic surface
- This magnetic rubber base will not damage the car body
- ABS extension for easy storage of non-metallic parts
- The extension allows items to be stored in vertical position without falling down
- Made of stainless steel
- External diameter: 150 mm
- Retail packed

BMD150	7314150242238	1	160 mm	160 mm	30 mm		405 g

BMR240

Rectangular magnetic tray



- Rectangular magnetic storage tray
- Used to store bolts, nuts and tools, for example in the repair shop
- Featuring a magnetic base with rubber protection so that the dish can be attached to any magnetic surface
- This magnetic rubber base will not damage the car body
- ABS extension for easy storage of non-metallic parts
- The extension allows items to be stored in vertical position without falling down
- Made of stainless steel
- Dimensions: 240 x 140 mm
- Retail packed

BMR240	7314150242245	1	250 mm	150 mm	250 mm	30 mm	745 g



TOOLS FOR ENGINES





BLT550

Laser thermometer

- Non-contact infrared thermometers with a laser pointer for checking temperatures of engines, coolants, A/C, exhausts, machine parts, circuit boards, heaters, etc.
- Temperature range: -50°C to +550°C
- Accuracy: ±1.5% or ±1.5°C
- Distance spot ratio: 12:1
- Resolution: 0.1°C
- Response time: 500 ms
- Wavelength: 8-14 μm
- 12 hour battery life in laser mode
- Battery: 9V 6LR61 (not included)
- CE certified

BLT550	7314150243556	10	40 x 95 x 145 mm	-50 +550 °C	130 g



BE5400P

Digital petrol engine compressor tester

- Used to measure the pressure in the combustion chamber of a petrol engine
- Equipped with a 1.5" LCD digital gauge with side valve for quick re-test and a quick coupler
- Can display readings in bar [0-21], psi [0-300] and kPa [0-2068]
- Allows storing of six compression readings
- Set contents
- Flexible hose (length: 300 mm) with spring loaded quick connection and dual M14/M18 adaptor
- Straight and angled rubber sealed pressure pieces
- Adaptors for various spark plug thread sizes
- M10x1.0 - M12x1.25 - M14x1.25
- Assortment of different O-rings
- 1 x AAA battery included
- Supplied in a blow moulded case, for better tool management
- CE certified

				BAR	PSI	
BE5400P	7314150245086	1	70 x 160 x 260 mm	0-21 bar	0-300 psi	840 g



BE5401D

Diesel compression tester

- Used to measure the pressure in the combustion chamber on diesel engines
- Collar system allows easy matching of injector profile
- It covers most of the latest engines
- Application chart included
- Features a large 60 mm gauge with an operating range of 0-69 bar / 0-1000 psi and a coiled rubber hose with right angle connection
- A wide selection of glow plug and injector adaptors with claw and clamp-on attachment
- Set contents
- 90° adaptor
- 20 dummy glow plugs
- Five injector adaptors
- Two packs of spare seals/washers and nozzle
- One clamp and claw adaptor set
- Six clamp-on injector adaptors suitable for cars, vans, trucks, buses, agricultural and marine injector sizes
- Suitable for use where the injector is held in place by a clamp, claw or bridge
- Supplied in a blow moulded case, for better tool management

BE5401D	7314150245062	1	105 x 325 x 410 mm	4.19 kg



BE410

Cooling system purging and filling set

- Allows flushing, leak testing and filling of the cooling system under vacuum
- Using a pneumatic (it needs compressed air) and vacuum system avoids trapped air pockets that cause thermostat malfunction
- Quick couplings for increased safety and reduced task time
- The conical adaptor makes the system universal, covering the majority of the vehicle fleet
- Set contents:
 - Main device
 - Hose for coolant
 - Conical adaptor [Ref. BE4101]
- Supplied in a blow moulded case, in foam inlay for better tool management

BE410	7314150205813	4	80 x 300 x 375 mm	1.95 kg



BE400P24

Cooling system pressure tester set

- Used to leak test the cooling system
- All components have quick couplings for increased safety and reduced task time
- Quick and simple operation: It applies pressure to the cooling system
- If the pressure is maintained, there is no leak
- If the pressure drops, there is a leak
- Universal. Suitable for a wide range of vehicle engines for various makes
- Application chart included
- Set contents:
 - Pressure test pump with gauge [0-2.5 bar / 0-362 psi] and quick coupling
 - Thermometer [50°C-150°C]
 - 16 different colour coded adaptors made of ABS
 - 1 ABS wrench for adaptor tightening
 - 3 metallic adaptors for different applications
 - 2 universal car cap testing adaptors
- Supplied in a blow moulded case, in foam inlay for better tool management

BE400P24	7314150205806	1	127 x 435 x 510 mm	4.19 kg



BE5200

Engine oil pressure tester set

- Used to check oil pressure in engine and transmission systems
- Quick and accurate system, using adaptors or a clamp that attaches directly to the oil filter
- Set contents
 - Pressure tester hose and gauge with bar [0-10] and psi [0-150] scales
 - 90° adaptor
 - Engine oil pressure quick test clamp [Ref. BE530001]
 - SAE adaptors [black finish]
 - 1/2" x 20 UNF - 3/8" x 20 UNF - 1/4" x 18 NPT - 1/8" x 27 NPT - R 1/8" DIN
 - Metric adaptors [chrome finish]
 - M10 x P1.0 - M12 x P1.5 - M14 x P1.5
- It covers the majority of vehicle models and manufacturers
- Supplied in a blow moulded case, in foam inlay for better tool management

				BAR	PSI	
BE5200	7314150205905	1	85 x 355 x 445 mm	0-10 bar	0-150 psi	2.89 kg



BE1311P13

Injector puller set

- Used to remove Siemens, Bosch, Delphi and Denso injectors
- Supplied with 10 different sockets and adaptors
- Includes a 4 kg slide hammer for forceful pulling
- Equipped with a ball joint to facilitate pulling in different positions
- Sockets and adaptors are sold individually
- High performance alloy steel
- Supplied in a blow moulded case, in foam inlay for better tool management

BE1311P13	7314150235414	1	80 x 355 x 445 mm	9.42 kg



BE1320S17

Diesel injector seat cleaner set

- Developed for efficient cleaning of diesel injector walls and seating surfaces
- Essential operation before installing new injectors in order to get perfect contact surfaces, avoiding blowback
- Different diameter brushes and tools allow a wide range of engines
- M5 closure sleeves and a threaded insertion tool used to seal the injection port, preventing particles from entering to the combustion chamber
- Brass coated steel wire brushes are used for cleaning the carbon particles on the inner walls
- Silicone nylon brushes confere a smooth finish to the injector base seat area
- The steel wire brush used to clean the injection nozzle port
- The 6 mm hexagonal adaptor and a 226mm long flexible bit driver that it is ideal to be used with our cordless drill
- Supplied in a blow moulded case, in foam inlay for a better tool control
- Set content: 17 pieces
- Five brass coated steel wire brushes of Ø18, Ø19, Ø21, Ø24 and Ø26mm
- Two silicone nylon brushes of Ø15 and Ø20mm
- Six M5 closure sleeves
- One threaded insertion tool
- One steel wire brush
- One long flexible bit driver
- One 6 mm hexagonal adaptor

BE1320S17	7314150415366	10	76 x 266 x 355 mm	1.26 kg



BE1315P7

Diesel injector seat cutter

- This set of five diesel injector cutters is used to clean the injector seat to ensure that it has the right dimension when replacing or reworking the injector
- Reworking the injector seat with this set avoids bad starting, hesitation on acceleration, black deposits, etc. and affecting vehicle's ECU
- Set contents.
- T-handle [ref. BE1315P71]
- Centring guide [ref. BE1315P72]
- Cutters
- 15 x 19 mm flat cutter for various car makes [ref. BE1315P73]
- 17 x 17 mm angled cutter for various car makes [ref. BE1315P74]
- 17 x 17 mm flat cutter for BMW, PSA, Renault, etc. [ref. BE1315P75]
- 17 x 19 mm flat cutter for Mercedes CRD engines, etc. [ref. BE1315P76]
- 17 x 21 mm angled cutter for Fiat Group, Iveco, etc. [ref. BE1315P77]
- High performance alloy steel
- Components and spare parts available
- Supplied in a blow moulded case, in foam inlay for better tool management

BE1315P7	7314150205776	1	68 x 225 x 280 mm	1.42 kg



BE13ZL11

Diesel injector tester

- Used to test the status of the diesel injectors outside the engine
- By checking the pressure at which the injector releases, the correct pressure of atomised fuel and the homogeneity of the different flows
- The pump can also be used to detect leaks in the fuel feed line
- Large gauge, measuring range: 0 – 600 bar
- Body made of aluminium
- For safety reasons, use of ISO 4113 oil (instead of fuel) is highly recommend for testing
- Operating instructions included

			BAR		
BE13ZL11	7314150239733	1	0-600 bar	480 x 230 x 280 mm	4.24 kg



BE762

Valve lapper set

- Used to achieve a proper contact surface on the valve seat, free from contamination
- EPDM suction cups resistant to oil and grease
- High strength wooden handle
- Suction cups sized for the most common valve sizes
- Large size - 255 mm length / Suction cups Ø32-Ø22 mm
- Small size - 245 mm length / Suction cups Ø22-Ø19 mm
- For use with grinding paste (not included)
- Retail packed

BE762	7314150384983	12	30 x 90 x 315 mm	68 g



BE1300

Diesel injector washer puller

- Used to remove/install copper washers of diesel injectors
- Enables quick, easy and safe removal/installation of the washers
- The 230 mm length allows working on deeply recessed injectors
- Claw made of high performance alloy steel
- For use with the copper injection sealing ring set [re. BE1305P450]
- Retail packed

BE1300	7314150205578	1	230 mm	35 x 35 x 260 mm	0.405 kg



BE76101

Valve spring compressor removal tools

- Used to easily remove or exchange valve springs on standard cars
- Capacity: 60 - 125 mm
- High performance alloy steel
- Nickel & chrome plated finish

BE76101	7314150240005	1	60 - 125 mm	40 x 200 x 290 mm	1.14 kg

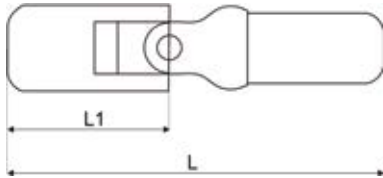

BE1GP5

Glow plug socket set



- Glow plug universal bi-hexagonal socket set
- Equipped with a spring ring ball type retainer system to prevent the glow plug from falling down when removing or installing
- Cardan system enables access to difficult-to-reach places and provides flexibility
- Suitable for a wide range of glow plugs on the market
- Drive: 1/4"
- High performance alloy steel
- Hardness: 43-47 HRC
- Supplied in a blow moulded case for better tool management
- Ideal for use with BE1GP5-T T-handle
- All sizes available individually

BE1GP5	7314150170043	1	1/4 in	8, 9, 10, 12, 14 mm	70 mm	52 mm	110 x 240 x 40 mm	0.46 kg	

BE1GP514, BE1GP510, BE1GP512, BE1GP58, BE1GP59



BE1GP5-T

T-handle for glow plug sockets

- Allows reaching any difficult place when working with glow plugs
- Equipped with a 160 mm sliding bar
- 1/4" drive to avoid applying too much torque to the glow plugs
- High performance alloy steel
- Matt chrome plated finish
- Ideal for use with BE1GP5 glow plug socket set
- Retail packed

BE1GP5-T	7314150170050	10	1/4 in	400 mm	15 x 160 x 400 mm	375 g

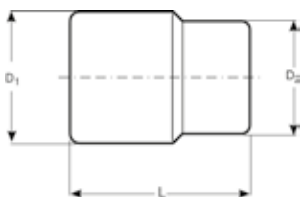

BE1SP

Spark plug wrench



- Spark plug wrenches used to fit or remove spark plugs from engines
- Internal rubber retaining system to secure spark plug
- Bi-Hex profile, metric sizes
- 3/8" square drive
- High performance steel
- Matt chrome plated finish

BE1SP16L	7314150492756	10	3/8 in	16 mm	5/8 in	252 mm	20.5 mm	20.5 mm	480 g
BE1SP14L	7314150170074	1	3/8 in	14 mm	9/16 in	252 mm	18 mm	18 mm	345 g



BE1T14/BE1T16/BE1T21

Spark plug wrenches

- Used to install/remove spark plugs
- Swiveling socket for reaching difficult areas
- The long bar allows application of controlled torque and provides easy access to screws requiring depth
- Rubber retaining system
- High performance alloy steel
- Chrome plated finish

BE1T14	7314150167630	1	14 mm	65/310 mm	495 g
BE1T16	7314150167647	1	16 mm	63/450 mm	630 g
BE1T21	7314150167654	1	21 mm	67/450 mm	685 g

7402GPR

3/8" square drive spark plug sockets



- Spark plug socket used to fit or remove spark plugs from engines
- Internal rubber retaining system to secure spark plug
- 3/8" square drive
- Hex profile with metric sizes
- Not suitable for machine operation
- High performance alloy steel
- Chrome plated micro-matte finishing provides high quality surface

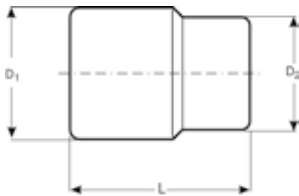

					L	D1	D2	
7402GPR-16	7314150503087	120	16 mm	3/8 in	61 mm	21.6 mm	19 mm	88 g
7402GPR-18	7314150503094	120	18 mm	3/8 in	65 mm	24.2 mm	19 mm	104 g
7402GPR-21	7314150503100	100	21 mm	3/8 in	65 mm	27.8 mm	22 mm	145 g

7805GPR

1/2" square drive spark plug sockets



- Spark plug socket used to fit or remove spark plugs from engines
- Internal rubber retaining system to secure spark plug
- 1/2" square drive
- Hex profile with metric sizes
- Not suitable for machine operation
- High performance alloy steel
- Chrome plated micro-matte finishing provides high quality surface

					L	D1	D2	
7805GPR-16	7314150503117	120	16 mm	5/8 in	64 mm	22 mm	22 mm	89 g
7805GPR-21	7314150503124	100	21 mm	13/16 in	64 mm	28 mm	23.1 mm	144 g

BE1P

Spark plug pliers



- Used to pull off spark plug caps without damaging the cables
- Long for reaching difficult areas
- Anti-slip PVC handle
- High performance carbon steel
- Chrome plated matt finish
- Retail packed in a plastic bag with info card

BE1P	7314150170067	1	290 mm	50,5 mm	20 x 50 x 290 mm	255 g



BE1205
Glow plug puller

- Once the glow plug has been unscrewed, this puller allows you to extract glow plugs in hard to reach areas
- Also suitable where there is a lack of space between the glow plug and cylinder head
- Time saver. The glow plug is grasped by its head and pulled out using the 6 mm and 19 mm hexagonal screw
- Suitable for 9 mm and 10 mm units
- Claw made of high performance alloy steel
- Retail packed

BE1205	7314150205554	1	35 x 35 x 130 mm	0.275 kg



BE1200P6
Glow plug chamber cleaning set

- Used to ream and clean the bore of the glow plug aperture, and the sealing seat when replacing the glow plugs
- Suitable for 8 mm and 10 mm glow plugs
- Easy, safe and quick to use
- Can be used individually or with a 1/4" ratchet
- Set contents
- Extension bar M4 x 0.7 x 130 mm
- Reamers [ref. BE1200P6AC1]: M8 and M10
- Reamer guides [ref. BE1200P6AC1]: M8x1.0P, M10x1.0P and M10x1.25P
- Supplied in a blow moulded case, in foam inlay for better tool management

BE1200P6	7314150205516	1	50 x 115 x 260 mm	0.49 kg



BE513201
Universal set for removing broken glow plugs

- M8-M9-M10 glowplug removal tool kit for PSA Group / Ford / Mazda/ SUZUKI / TOYOTA 1.4-1.6 diesel
- This set includes all the tools needed to safely remove the terminal part of the glow plug electrode without damaging the cylinder head
- This task becomes very simple and fast. The alternative is to disassemble the head, so the time savings are considerable
- Suitable for removing the final part of the electrode in case of breakage or seizure of the glow plug M10 inside its seat, otherwise impossible to remove
- Application chart and user manual included in the kit
- Component list with OEM tool codes included
- More info about this kit in our website tool <https://enginetoofinder.bahco.com/>
- Application video also available
- Supplied in a blow moulded case, in foam inlay for better tool management



BE513201	7314150274802	1	95 x 270 x 350 mm	2.10 kg

BE51320101	
BE51320102	
BE51320103	
BE51320104	
BE51320105	
BE51320106	
BE51320107	
BE51320108	
BE51320109	
BE51320110	
BE51320111	
BE51320112	
BE51320113	
BE51320114	



BE1210P11

Glow plug thread repair set

- This set is used to repair or restore damaged 8 and 10 mm glow plug threads
- Easy and quick to use
- Set contents
- Fitting rod
- Plug end blanks
- Taps
- M8x1.0
- M10x1.0
- M10x1.25
- Insert fitting tool
- M8x1.0 - M10x1.0
- M10x1.25 - M12x1.25
- Inserts/coils
- 1 x M8x1.0
- 1 x M10x1.0
- 1 x M10x1.25
- Components and spare parts available
- Supplied in a blow moulded case, in foam inlay for better tool management

BE1210P11	7314150209101	1	50 x 120 x 260 mm	0.62 kg



2633HD/S6

Seal and soft hose removal and picking tool set

- Used to remove seals and soft O-rings or pick up hoses and other objects
- Set contents
- 6 differently shaped and sized tools
- Wide range of applications
- These different shapes and lengths allow the removal of all kinds of seals, O-rings, etc.
- High performance alloy steel
- Comfortable TPR handle
- Supplied in a blow moulded case, in foam inlay for better tool management

2633HD/S6	7314150205783	1	80 x 270 x 375 mm	1.67 kg



BE6FCP

In-line fuel filter connection pliers

- For removal and replacement of fittings on in-line fuel filters
- Suitable for a wide range of engines
- Special pliers tip can move these fittings forward (locked) and backward (unlocked)
- Tip design suitable for use with the latest fittings
- Essential tool for petrol engine maintenance tasks
- Long reach access

BE6FCP	7314150438907	30	35 x 56 x 218 mm	104 mm	218 mm	0.290 kg



BE256P3

Hose clamp pliers set

- Quick fluid stopper tool set for throttle/block PVC hoses
- Can be used on most flexible hose lines of fuel, heaters, cooling systems, radiators, brakes, etc.
- One hand adjustment system with jaws
- Set contents:
 - Short size pliers length: 155 mm [Ref. BE256-155]
 - Medium size pliers length: 178 mm [Ref. BE256-178]
 - Long size pliers length: 250 mm [Ref. BE256-250]
- Made of nylon and glass fibre
- Also available individually under above references

BE256P3	7314150205868	1	40 x 93 x 330 mm	155-185-250 mm	0.25 kg



BE5100

Adjustable universal camshaft locking tool

- For locking the camshaft when disassembling parts of the engine
- Suitable for all double overhead camshafts (DOHC) on diesel and petrol engines
- Adjustable to two different lengths, enabling universal coverage
- Small levers on the screws facilitate fast tightening, even in constrained spaces
- High grade alloy steel

BE5100	7314150205646	1	345 x 150 x 85 mm	0.48 kg



BE800P12

A/C repair tool set

- Tool set for installation and removal of air conditioning ECU, airflow/mass sensors, injection pumps, etc.
- It covers the majority of vehicle manufacturers
- Set contents:
 - Hex bit holder
 - Tamper Torx® plus bits: TP10H, TP15H, TP20H, TP25H
 - Sockets: 8pt x 12 mm and 8pt x 15 mm
 - Special bit 2.2 mm and 3.2 mm
 - 1/4" drive
- Supplied in a blow moulded case, in foam inlay for better tool management

BE800P12	7314150205677	1	43 x 90 x 200 mm	0.38 kg



5515FUV

Pivoting inspection mirror with UV and insulated semi-rigid cable

- Used for detecting air conditioning gas or fluid leaks
- Semi-rigid cable allows inspections into hard-to-reach spots
- The 2 powerful UVs light up the darkest areas
- Cable insulation allows up to 125°C
- On/off switch controls the light
- Total length: 550 mm
- Soft grip handle
- Includes an UV light and safety glasses - 2 x CR2032 battery included
- CE certified by accredited inspection body

5515FUV	7314150540143	1	550 m	65x42 mm	229 g



BE74-55100/BE74-80120

Piston ring tongs

- Used to quick and easy installation or removal of piston rings
- Provide safe operation without the risk of breaking or damaging piston rings
- BE74-55100 diameter capacity: Ø 55 - 100 mm
- BE74-80120 diameter capacity: Ø 80 - 120 mm
- Handle with PVC for hand protection and better grip
- Retail packed

BE74-55100	7314150169733	1	55-100 mm	20 x 130 x 205 mm	250 g
BE74-80120	7314150169740	1	80-120 mm	20 x 145 x 220 mm	280 g



BE74-57125/BE74-90175

Piston ring tightener

- Used for quick and easy removal or installation of piston rings
- Provide safe operation without the risk of breaking or damaging piston rings
- Easily enables locking of piston rings in the desired position
- BE74-57125L Includes an anti wind-up ratchet
- BE74-57125 diameter capacity: Ø 57 - 125 mm. Length: 80 mm
- BE74-90175 diameter capacity: Ø 90 - 175 mm. Length: 165 mm
- BE74-57125L diameter capacity: Ø 57 - 125 mm. Length: 80 mm

BE74-57125	7314150169511	1	80 mm	57-125 mm	75 x 78 x 115 mm	220 g
BE74-90175	7314150169528	1	165 mm	90-175 mm	85 x 125 x 225 mm	500 g
BE74-57125L	7314150169535	1	80 mm	57-125 mm	75 x 78 x 115 mm	264 g





TOOLS FOR BATTERIES





BBAGM12-1200
Booster 12V 1200 CA

- 1200 cranking amps 12V powerful AGM booster
- 25 mm² copper area in cables ensures extremely high conductivity
- Equipped with heavy duty clamps with copper bridge for complete amperage transfer the battery that needs boosting
- Convenient voltmeter for easy checking of internal battery status
- Safety features:
 - Reverse polarity protection
 - Internal fuse: 500A
 - Cable length: 1.61 m
- Supplied with an automatic electronic charger with three-colour LED indicator
- Lighter plug charger is available as an option [Ref. BBAGMCAB]
- 12V output with 16A internal fuse to operate small devices
- It can be used as a memory saver together with our BELMS12OBDL
- CE certified by Official Independent Technical Inspection Association

BBAGM12-1200	7314150535675	1	12 V	1200 A	25 A·h	25 mm ²	1800 mm	-20 / +50 °C	3 A	185 mm	37 mm	X	355 x 295 x 235 mm	13.01 kg



BBAGM1224-2400
Booster 12/24V 2400 / 1200 CA

- 2400/1200 cranking amps 12/24V powerful AGM booster
- Direct power: at 12V: 2400 CA, at 24V: 1200 CA
- The connector for selecting either 12V or 24V is made from the most robust industrial connectors on the market and equipped with a very comfortable handle
- 50 mm² copper area in cables ensures high conductivity
- Equipped with heavy duty clamps with copper bridge for complete amperage transfer the battery that needs boosting
- Convenient voltmeter for easy checking of internal battery status
- Safety features:
 - Reverse polarity protection
 - Internal fuse: 500A
 - Cable length: 1.70 m
- Supplied with an automatic electronic charger
- Lighter plug charger is available as an option [Ref. BBAGMCAB]
- 12V output with 16A internal fuse to operate small devices
- It can be used as a memory saver together with our BELMS12OBDL
- CE certified by Official Independent Technical Inspection Association

BBAGM1224-2400	7314150535682	1	12 / 24 V	2400 / 1200 A	25 A·h	50 mm ²	1800 mm	-20 / +50 °C	3 A	185 mm	37 mm	X	355 x 295 x 300 mm	23.72 kg





BBA1224-3200
12V/24V Heavy duty booster

- 3200 cranking amps at 12V and 1600 cranking amps at 24V, heavy duty booster
- Powered by two lead-acid AGM spiral batteries with pure lead plates, extremely effective in delivering high power at high cranking amperage almost instantaneously
- Extremely powerful
- Cranking amps: 12V: 3200A / 24V: 1600A
- Suitable and specifically designed for heavy duty vehicles, such as buses, trucks or tanks
- Heavy duty construction
- Equipped with heavy duty, fully insulated clamps with wide 54 mm opening, able to transfer full current to the battery that needs boosting
- High quality double insulated starter cables, 1.95 metres long with 70 mm² wire cross-section, featuring optimal length, flexibility and extremely high conductivity
- Clamps equipped with a copper bridge for reliable current spreading on both bronze jaws
- The connector for selecting either 12V or 24V is made from the most robust industrial connectors on the market and equipped with a very comfortable handle
- Equipped with a very easy and intuitive control panel with a voltmeter, a 16A external fuse and a 12VDC socket-outlet
- Provided with a smart charger that is 100% fully automatic and microprocessor controlled to allow multiple charging steps for added accuracy, safety and increase battery life
- Multiple safety features
- Reverse polarity protection
- Equipped with a 500A fuse for protection against short-circuits or over-long starting attempts
- Monolithic construction made of roto-moulded polyethylene, nearly unbreakable and resistant to all fluids used in garages, including brake fluid
- Features a gas release safety valve that prevents gas accumulation and drastically reduces the risk of explosion
- Operating temperature: -20°C < / > 50°C
- CE certified

BBA1224-3200	7314150341955	1	12/24 V	3200/1600 A	2 x 50 A·h	70 mm ²	1950 mm	-20 < °C < 50 °C	7 A	215 mm	54 mm	X	970 x 320 x 430 mm	55 kg



BBJL
Jumper leads

- Used to start vehicles by connecting batteries between them
- Fully insulated cables and clamps
- Clamps and leads are made of high conductivity materials
- Ensure an optimal connection and current transfer
- There are different sizes depending on the current that will pass through the cables and clamps
- Guidance on the largest type of vehicle for which each model can be used is defined in the following table as:
- P/D: P stands for petrol and D for diesel
- Then engine displacement in litres is stated with maximum of:
- 2.5, 4.0 or 5.5 for petrol engines and
- 1.5, 2.0 or 3.0 for diesel engines

BBJL1630	7314150244898	5	16 mm ²	3 m	P-2.5 l / D-1.5 l	500 A	1.27 kg
BBJL2535	7314150209453	1	25 mm ²	3.5 m	P-4.0 l / D-2.0 l	1000 A	2.680 kg
BBJL3545	7314150209460	1	35 mm ²	4.5 m	P-5.5 l / D-3.0 l	1000 A	4.04 kg



BBCE12-3

3 Amp fully automatic charger/maintainer for 12v lead-acid and lithium lifep04 batteries

- Suitable for motorbikes, quads, lawn mowers, small boats, cars, etc.
- Aided by “Connect and Forget” microprocessor controlled technology with multi-level charging for added precision, safety and longer battery life
- Designed for all types of lead-acid batteries such as AGM, Cal/Cal, Gel, SLI, VRLA, EFB including Start&Stop, as well as lithium LiFePO4
- Float-mode monitoring: Automatically maintains optimum battery charge
- Reverse polarity protection
- Scrolling digital display providing step-by-step instructions for the correct battery charging process, in the following languages: English, French and Spanish
- Quick-connect security: Attach either ring connector into place in seconds
- Battery charging range 12V: 6-58Ah
- Input: 230V AC 50Hz Output: 12V DC @ 3A IP64
- Box contents: 3A 12V charger/maintainer, clamp adapter, fused ring leads harness and user manual
- CE certified

			V	A					IP			
BBCE12-3	7314150330249	2	12 V	3 A	X	6-58 A-h	1970 mm	X	23 mm	64	204 x 75 x 192 mm	790 g



BBCE12-6

6 Amp fully automatic charger/maintainer for 12v batteries

- Suitable for lawnmowers, boats, cars, campers, commercial vehicles, buses, agriculture vehicles, etc.
- Aided by “Connect and Forget” microprocessor controlled technology with multi-level charging for added precision, safety and longer battery life
- Designed for all types of lead-acid batteries like AGM, Cal/Cal, Gel, SLI, VRLA, EFB including Start&Stop
- Float-mode monitoring: Automatically maintains optimum battery charge
- Reverse polarity protection
- Scrolling digital display providing step-by-step instructions for the correct battery charging process, in the following languages: English, French, Spanish, German, Swedish and Italian
- Quick-connect security: Attach either ring connector into place in seconds
- Battery charging range 12V: 6-130Ah
- Input: 230V AC 50 Hz Output:12V DC @ 6A IP20
- Box contents: 6A 12V charger/maintainer, clamp adapter, fused ring leads harness and user manual
- CE certified

			V	A					IP			
BBCE12-6	7314150330256	2	12 V	6 A	X	6-130 A-h	2200 mm	X	23 mm	20	205 x 80 x 237 mm	1190 g



BBCE12-10

10 Amp fully automatic charger/maintainer for 12v batteries

- Suitable for boats, cars, camping vans, commercial vehicles, buses, agricultural vehicles, trucks, etc.
- Aided by “Connect and Forget” microprocessor controlled technology with multi-level charging for added precision, safety and longer battery life
- Designed for all types of lead-acid batteries like AGM, Cal/Cal, Gel, SLI, VRLA, EFB including Start&Stop
- Float-mode monitoring: Automatically maintains optimum battery charge
- Reverse polarity protection
- Scrolling digital display providing step-by-step instructions for the correct battery charging process, in the following languages: English, French, Spanish, German, Swedish and Italian
- Quick-connect security: Attach either ring connector into place in seconds
- Battery charging range 12V: 10-200Ah
- Input: 230V AC 50Hz Output: 12V DC @ 10A IP20
- Box contents: 10A 12V charger/maintainer, clamp adapter, fused ring leads harness, and user manual
- CE certified

			V	A					IP			
BBCE12-10	7314150330263	2	12 V	10 A	X	10-230 A-h	2200 mm	X	23 mm	20	205 x 80 x 240 mm	1220 g



BBCE12-15S

15 Amp fully automatic charger/maintainer for 12v batteries with supply mode



- Equipped with Supply mode feature, delivering 10 amps max. when needed, because It will adapt itself to the vehicle's need
- Perfect for keeping connected to the vehicle battery when the vehicle is in the showroom to demonstrate the lights, GPS, etc. in order not to run out of battery, maintaining a stable voltage of 13.6V
- Suitable for boats, cars, camping vans, commercial vehicles, buses, agricultural vehicles, trucks, etc.
- Aided by "Connect and Forget" microprocessor controlled technology with multi-level charging for added precision, safety and longer battery life
- Designed for all types of lead-acid batteries like AGM, Cal/Cal, Gel, SLI, VRLA, EFB including Start&Stop
- Float-mode monitoring: Automatically maintains optimum battery charge
- Reverse polarity protection
- Scrolling digital display providing step-by-step instructions for the correct battery charging process, in the following languages: English, French, Spanish, German, Swedish and Italian
- Quick-connect security: Attach either ring connector into place in seconds
- Battery charging range 12V: 10-230Ah
- Input: 230V AC 50Hz 2.5A /1.8A Output: 12V @ 15A/10A IP20
- Box contents: 15A/10A 12V charger/maintainer with Supply Mode, clamp adapter, fused ring leads harness and user manual
- CE certified

			V A						IP		
BBCE12-15S	7314150406722	2	12 V 10/15 A	X	10-230 A-h	1850 mm	X	23 mm	20	245 x 90 x 225 mm	1730 g

BBCE24-10

10 Amp fully automatic charger/maintainer for 24v batteries



- Suitable for commercial vehicles, buses, agricultural vehicles, trucks, etc.
- Aided by "Connect and Forget" microprocessor controlled technology with multi-level charging for added precision, safety and longer battery life
- Designed for all types of lead-acid batteries like AGM, Cal/Cal, Gel, SLI, VRLA, EFB including Start&Stop
- Float-mode monitoring: Automatically maintains optimum battery charge
- Reverse polarity protection
- Scrolling digital display providing step-by-step instructions for the correct battery charging process, in the following languages: English, French, Spanish, German, Swedish and Italian
- Quick-connect security: Attach either ring connector into place in seconds
- Battery charging range 24V: 20-230Ah
- Input: 230V AC 50Hz Output: 24V DC @ 102A IP20
- Box contents: 10A 24V charger/maintainer, clamp adapter, fused ring leads harness and user manual
- CE certified

			V A						IP		
BBCE24-10	7314150330287	2	24 V 10 A	X	20-230 A-h	2200 mm	X	23 mm	20	243 x 90 x 225 mm	1460 g

BBCE12-F100

100A Battery charger / Power supply



- 70 amp fully automatic battery charger/maintainer for 12V batteries
- Able to supply up to 70 amperes continuously, but can reach 100A for a period of 3 minutes
- It is also a power supply that maintains a stable voltage (allowing voltage adjustment between 13.0-14.8V) under varying loads, during major vehicle ECU reprogramming and diagnostic work
- Application: boats, passenger cars, campers, commercial vehicles, buses, agriculture vehicles, trucks, etc.
- Aided by microprocessor controlled technology
- This technology allows a multi-rate charging sequence for added precision, safety and increase battery life
- Designed for all types of lead-acid batteries such as AGM, Cal/Cal, Gel, VRLA, and Start&Stop batteries
- Charging mode can be set to Automatic or Manual mode, where you can set the charging rate to 4, 20 or 70 amps
- Manual mode allows the desired charging time to be set
- Desulphating mode, achieving 15.8V max
- Showroom (Supply) mode available
- Float-mode monitoring: Automatically maintains optimum battery charge
- Heavy duty construction
- Andersson connector that ensures an optimal connection and current transfer
- Heavy-duty clamps with replaceable jaws on a 5 metre cable, with 42 mm clamp opening width and equipped with a copper bridge between the clamp jaws to ensure even current distribution between the jaws
- Safe
- Reverse polarity protection
- Dual temperature-controlled cooling fans
- Adjustable mounting brackets for easy permanent installation on most shop post lifts
- Operating temperature: -20 °C / +40 °C
- Working life (MTBF): 85,000 hours
- Package contents: Charger/maintainer, clamps, power supply cable, 4 mounting brackets and screws, and user manual in 16 languages
- CE certified

BBCE12-F100	7314150344710	1	12 V	4/20/70/100A A	X	0 - 2000 A-h	35 mm ²	5000 mm	X	42 mm	20	450 x 140 x 450 mm	9820 g

BELMS12OBDL

On board diagnostic memory saver detector



- Used to maintain power to the vehicle and save the vehicle's diagnostic computer settings (radio programs, diagnostic codes, etc.) while the battery is disconnected from the vehicle during repair, maintenance or replacement, by connecting it between a portable power unit and the vehicle's On-Board Data (OBDII) diagnostic port
- Suitable for 12V vehicles
- Auto Detection: Detects automatically if the vehicle's electronics will allow this device to save onboard data
- Clear 3-step instructions printed on unit
- 2 yellow LED indicators at each end indicate that the OBDII socket connection and the connection to the portable power unit are okay
- Red LED (Do not proceed) or Green LED (Proceed) indicates whether it is safe to remove the vehicle's battery without fear of losing data stored in the vehicle
- Works with all 12V vehicles equipped with a standard OBDII port
- We recommend our Bahco boosters BBA12-1200 or BBA1224-1700 as the best portable power units for use with this memory saver detector
- Standard fuse protected auxiliary input plug
- Retail packed
- CE certified according to Directive 2014/30/EU

BELMS12OBDL	7314150340323	8	40 x 70 x 140 mm	12 V	2000 mm	X	340 g



BBC420-BBC620

Mobile charger / starter



- Multi-application device whose main purpose is to properly charge batteries
- It can also be used to crank vehicles with slightly discharged batteries. Do not use it to crank vehicles with low or dead batteries (use our boosters for that purpose)
- Available normal charge, quick charge or quick start modes
- Features a timer for quick charge
- Equipped with a display of charging and starting current
- Suitable for electrolyte batteries
- For 12V and 24V vehicles
- BBC420 starting power: 400 cranking amps at 12V
- BBC620 starting power: 570 cranking amps at 12V
- Safe
- Reverse polarity protection
- Overload protection
- Charge it via 230V power supply
- CE certified

				V	Hz		kW	A_{EFF}	A_{EN}	CA	L	W	H	
BBC420		7314150243235	1	230 V	50/60 Hz	20/1000 A-h	1,6-10 kW	75	50	400 A	330 mm	360 mm	650 mm	18 kg
BBC620		7314150243242	1	230 V	50/60 Hz	20/1550 A-h	2-10 kW	90	70	570 A	325 mm	465 mm	730 mm	26 kg

BBT20

12V Digital battery tester



- Battery charge and charging system tester
- Indicates battery status with three different readings: OK, WEAK or BAD
- Can be used for vehicle alternator testing
- Reverse polarity control function with audible alarm function
- Working range 200 to 1000 CCA
- Cable length: 50 cm
- User manual included
- Packed in a white cardboard box

				V			
BBT20		7314150166961	1	12 V	X	90 x 160 x 345 mm	0.97 kg

BBT60A

12V Digital battery tester



- Fast, safe and simple tester for quick and accurate battery and system test diagnosis
- Patented "Single Load, Dynamic Resistance" technology enables very accurate in-vehicle test results, reflecting the true condition of the tested battery
- Suitable for testing 12V Start&Stop batteries
- Features values reading in mΩ, essential data for accurately assessing the Start&Stop batteries' health status.
- No internal batteries needed for operation
- Capacity
 - 12V standard batteries
 - 12V and 24V charging/starting systems
 - Traditional liquid, VRLA (AGM flat plate and spiral/gel) and Start&Stop EFB and AGM
 - Working amperage range (SAE): 40 - 2,000 CCA
 - Voltmeter range: 8V - 31.5V
 - Complies with SAE, DIN, EN, IEC and JIS battery rating systems
- Test results
 - GOOD & PASS
 - GOOD & RECHARGE
 - RECHARGE & RETEST
 - BAD & REPLACE
 - BAD CELL & REPLACE
 - Charge state and state of health in percentage
- Backlit LED display with 4 lines for easy reading even in dim or dark areas
- Insulated clamps with 22 mm opening width
- Covered by a rubber protective case
- User interface in English, French, Spanish, German, Italian, Portuguese, Dutch, Russian, Turkish and Czech
- CE certified

				V						
BBT60A		7314150504169	36	12 V	40 - 2000 A-h	X	50 °C	X	27 x 95 x 135 mm	0.268 kg



BBT80

6V & 12V Digital battery tester with printer

- Fast, safe and simple tester for quick and accurate battery and system test diagnosis
- Due to its patented "Single Load, Dynamic Resistance" technology it is able to deliver the most accurate in-vehicle test results, reflecting the true condition of the tested battery
- Suitable for testing 12V Start&Stop batteries
- Features values reading in mΩ, essential data for accurately assessing the Start&Stop batteries' health status.
- Equipped with a thermal printer that it is a useful option for pre and post battery testing
- Capacity
 - 6V and 12V standard batteries
 - 12V and 24V charging/starting systems
 - Traditional liquid, VRLA (AGM flat plate and spiral / GEL) and Start&Stop EFB and AGM
 - Working amperage range (SAE): 40 - 2,000 CCA
 - Voltmeter range: 1.5V - 30V
 - Complies with battery rating system SAE, DIN, EN, IEC and JIS
- Test results
 - GOOD & PASS
 - GOOD & RECHARGE
 - RECHARGE & RETEST
 - BAD & REPLACE
 - BAD CELL & REPLACE
 - Charge State and State of Health in Percentage
- Backlit LED display with 2 lines for easy reading even in dim or dark areas
- Insulated clamps with 35 mm opening width
- User interface in English, German, French, Spanish, Italian and Portuguese
- Supplied in a sturdy plastic case with protective foam, including 6 AA batteries, paper roll, software CD and printed user manual
- CE certified

BBT80	7314150327805	6	6-12 V	40-2000 A-h	X	50 °C	X	64 x 130 x 251 mm	1.11 kg



BMMTRMS1

Digital multimeter, autoranging, true RMS 1000V, with port for connection to PC

- Precise and reliable, the Bahco BMMTRMS1 digital multimeter is the perfect solution for users looking for a tester that is easy and safe to use for measuring AC/DC voltage, current, frequency, resistance, capacitance, continuity, polarity and temperature. It includes:
- Multimeter bag with multimeter strap holder
- Needle probe set with silicone leads 1m long: Cat III 1000V, 10A
- Alligator clip test probe lead sets, spring-loaded copper clips with wide 12.7 mm (0.5 inch) jaw opening and serrated teeth, 1m long: Cat III 1000V, 10A
- T° sensor probe lead 1 m long
- Multimeter PC connectivity USB cable 1.2 m long
- USB memory stick loaded with PC Link connectivity software and user manual in the following 12 languages: English-French-Spanish-Swedish-Turkish-Russian-Portugese-Italian-Greek-Slovenian-Czech-Polish
- Calibration report
- 1 battery 6F22 (9V) included
- **Specifications:**
 - True RMS measurement - Non contact voltage feature - Relative measurement - Auto power-off - Data hold - Backlight function - Auto/manual range - Polarity indication - Diode test - Continuity test - Low battery power indication
 - DC voltage range: 600mV ±0.5%, 6V/60V/600V ±0.8%, 1000V ±1.0%
 - AC voltage range: 600mV/6V/600V ±1.0%, 1000V ±1.5%
 - DC current: 600uA/6mA/60mA/600mA/10A ±1.5%
 - CAT rating: CATIII 1,000V CATIV 600V
 - Resistance: 600Ω/6KΩ/60KΩ/600KΩ/6MΩ ±0.5%, 60MΩ ±1.5%
 - Capacitance: 6nF ±3.0%, 600nF/6uF/60uF/300uF ±5.0%
 - Logic frequency: 10Hz~1MHz ±(0.1%+3) / Linear frequency: 10Hz~10KHz ±(0.05%+8)
 - Duty cycle: 1%~99%
 - Temperature: -55°C~1000°C ±(2%+2)
 - Fuse protection: 0.63A/1000Vx1 for μA and mA ranges and 10A/1000Vx1 for 10A range

BMMTRMS1	7314150274024	1	155 x 60 x 225 mm	0.8 kg

BMVAT1000

1000V voltage absence tester, non-contact voltage tester



- Essential, simple, quick and safe device for electricians to check absence of voltage.
- Measurement tests available:
- Voltage up to 1000V (CATIV) VDC and VAC with precise reading thanks to the LCD screen and the bar graph.
- High Voltage Detection when voltage source >100VAC/VDC
- VDC Polarity Detection (+-) on main probe.
- Continuity for testing cables, fuses...with LCD screen flashing and buzzer
- Non-Contact Voltage Sensing when the sensor is near electromagnetic field greeter than 90VAC
- Phase Rotation
- Torch light when making measurement in dark environment.
- Auto-test function
- Auto-Power Off function
- Sturdy cables with double insulation 90cm long giving a max distance of 140cm between needle tips
- IP rate: 65 for working indoor and outdoor
- Voltage range: 6~1000VDC - 24~1000VAC
- Voltage bar indication: 6/12/24/50/120/230/400/690/1000V
- Accuracy: ±3%
- High Voltage Indication: 100V~1000V AC/DC
- Phase rotation measurement: 3 Phase 4 Lines
- Non contact Voltage sensing: > 90VAC
- Resistance: 0~1,3MΩ
- Conducting current: ≤5uA
- Battery: 2*AAA 1,5V
- Temperature: Operating: 0~50°C / Storage: -10~60°C
- Maximum distance between probes: 1,4m
- CAT Category: CATIV 1000V
- GS LVD: EN 61243-3
- EMC: EN 61326-1

BMVAT1000	7314150488360	50	310 x 50 x 100 mm	0.302 kg





BDACM1000

1000A AC/DC true RMS digital clamp meter

- Simple meter with current clamp for essential electrical tasks such as measuring AC/DC voltage or current, frequency, resistance, capacitance, continuity, polarity and temperature.
- 45mm jaw opening for measuring current without opening the electrical circuit.
- True RMS measurement <1KHz.
- Voltage up to 1000V DC and AC (CAT II)
- Backlit 1.8" LCD screen for accurate reading
- Measurement ranges:
- Voltage:
 - DCV: 400.0mV/4.000V/40.00V/400.0V/1000V
0.5% + 5 counts
 - ACV: 4.000V/40.00V/400.0V/1000V
1% + 5 counts
- Current:
 - DCA: 400.0A/1000A
2.5% + 6 counts
 - ACA: 400.0A/1000A
3.0% + 8 counts
- Resistance: 400.0Ω/4.000KΩ/40.00KΩ/400.0KΩ/4.000MΩ/40.00MΩ
0.5% + 3 counts
- Capacitance: 4.000nF/40.00nF/400.0nF/4.000uF/40.00uF/400.0uF/4.000mF
3% + 15 counts
- Continuity: 200Ω < 50Ω beep
- Diode test: 2V
- Frequency: 4.000Hz/40.00Hz/400.0Hz/4.000KHz/40.00KHz/400.0KHz/4.000MHz
0.1% + 5 counts
- Temperature: -200 ~ 1200°C
- Non contact voltage sensing: > 50VAC 50/60Hz
- Polarity indication.
- Auto/manual range.
- Overrange indication: "OL" display.
- Data hold mode.
- Max/Min function.
- Relative value function: Yes.
- Auto Power Off function.
- Low battery indication.
- Battery: 3 x AAA 1.5V
- Temperature range: Operating: 0 ~ 40°C / Storage: -10 ~ 60°C
- Set includes:
 - Alligator clip test probe leads, spring-loaded copper clips with wide 12.7 mm (0.5 inch) jaw opening and serrated teeth, 1m long.
 - Needle probe set with silicone leads 1m long.
 - Temperature sensor probe lead 1m long.
 - Quick guide
 - Calibration report
 - Bag with strap holder
- CAT category: CAT II 1000V - CAT III 600V
- LVD: EN 61010-1
- EN 61010-2-030
- EN 61010-031
- EN 61010-2-032
- EN 61010-2-033
- EMC: EN 61326-1

BDACM1000	7314150500819	30	60 x 143 x 250 mm	0.551 kg



BELS12

Memory saver 12V

- Saves the on-board vehicle data during battery changing or any other kind of repair that could affect the vehicle memory
- Intuitive design and easy to use
- Quick reading
- Cigarette lighter plug and external battery indicator ensure that connections are correct and operations are carried out safely
- CAN bus compatible
- CE certified

BELS12	7314150170579	1	12 V	4 m	X	35 x 63 x 160 mm	0.275 kg



BB10

Hydrometer battery tester

- This tool is used to test the battery charge state
- Easy test result reading thanks to the clear colour coded scale
- It determines the charge state by measuring the specific gravity (density) of the electrolyte
- The greater the concentration of sulphuric acid, the more dense the electrolyte becomes. The higher the density, the higher the charge
- Tube material glass
- Clean with water after each use and dry before next use
- Packed in a white cardboard box

BB10	7314150240586	1	50 x 50 x 285 mm	0.12 kg



2555

Terminal brush

- Used to remove corrosion and dirt from battery terminals and cable clamps
- The external brush cleans cable clamps
- The internal brush cleans terminal posts
- Steel bristles
- Metal housing

2555	7311518276041	1	85 mm	55 g

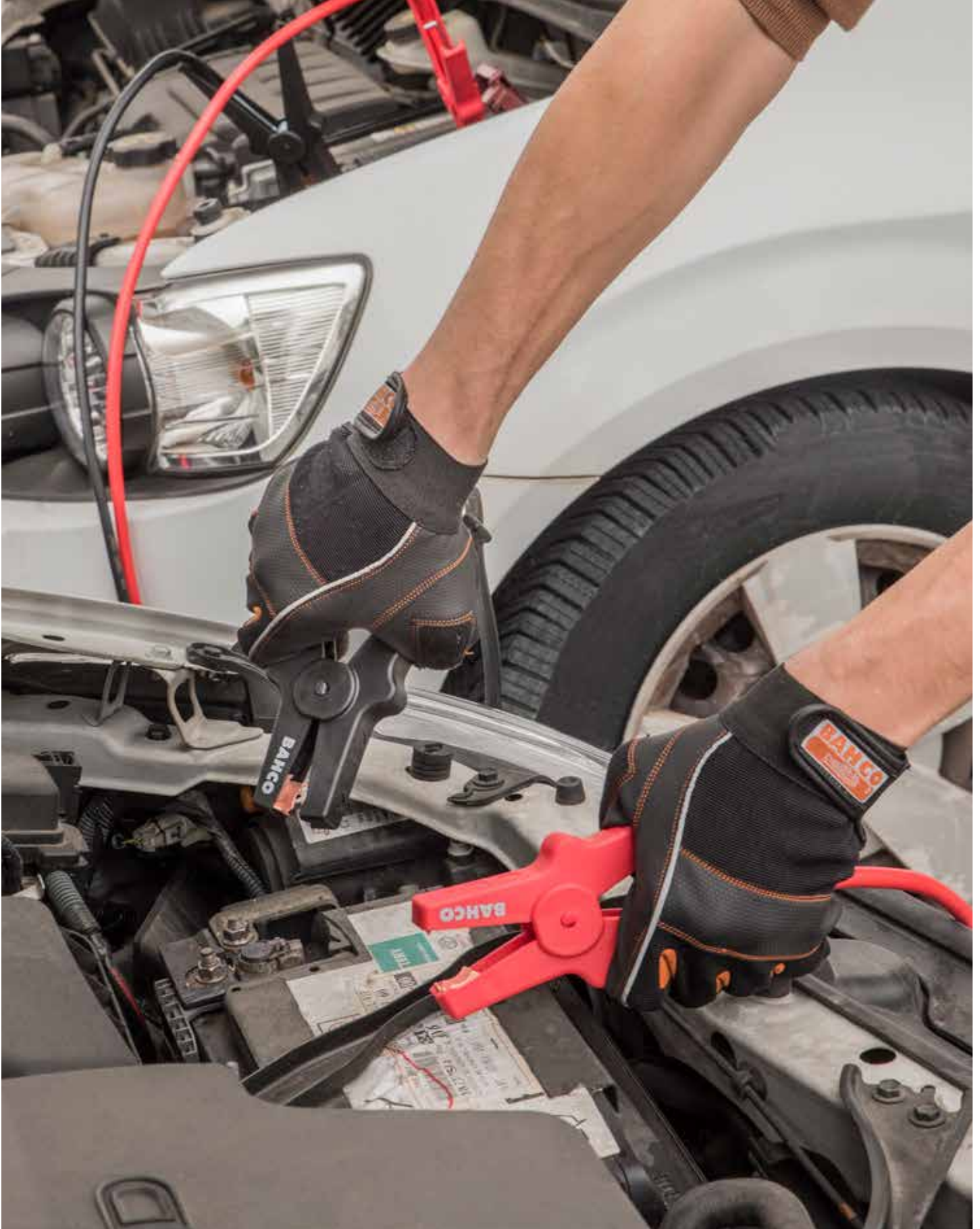



OIL AND FILTERS

BAHCO

**BOD8903A****2 in 1 oil drainer with tank capacity 90L and inspection chamber**

- 2 in 1 oil drainer used for gravity or suction (with vacuum venturi) draining of used oil from engines, gearboxes and differentials of all vehicles
- Includes a 9 litre chamber for immediate visual inspection of the quality of the extracted used oil
- This 9 litre chamber can also be used as a vacuum reservoir
- Includes a wide selection of various probes usable with a wide variety of vehicles, such as a copper probe for high temperature oil
- Flexible nylon: 5 x 700 mm, 6 x 700 mm, 7 x 1000 mm, 8 x 700 mm
- Rigid copper: 5 x 700 mm, 6 x 700 m
- Adaptors: for BMW, diameter 12.2 mm, and for VAG Group diameter 10 mm
- Suction rate: 1.5 to 2 l/min (oil at 70° and -80°C, with 6 mm probe and 8 bar/115 psi air pressure)
- Suction air pressure: 7-8 bar / 100-115 psi
- Maximum draining pressure: 1 bar / 14.5 psi
- Maximum draining and suction tank capacity: 90 l
- Reinforced connection between tank and oil tube to minimise the risk of leaks
- Swiveling offset funnel design for high flexibility with 18 litre capacity
- Metal reinforced hoses for improved durability
- Foam protected handle for insulation and to avoid scratches on vehicles in case of an accident
- Gauges indicating the level of contained liquid, air tank and suction pressures
- One swivel castor with brake for increased safety
- CE certified

BOD8903A	7314150265374	1	1340-1700 mm	608 mm	419 mm	1700 mm	36.17 kg	

**BOD8901****Gravity oil drainer with tank capacity 90L**

- Gravity oil drainer used to drain used oil from engines, gearboxes and differentials of all vehicles
- Maximum draining pressure: 1 bar / 14.5 psi
- Maximum draining and suction tank capacity: 90 l
- Reinforced connection between tank and oil tube to minimise the risk of leaks
- Swiveling offset funnel design for high flexibility with 18 litre capacity
- Metal reinforced hoses for improved durability
- Foam protected handle for insulation and to avoid scratches on vehicles in case of an accident
- Gauges indicating the level of contained liquid, air tank and suction pressures
- One swivel castor with brake for increased safety
- CE certified according to Directive 2006/42/EC

BOD8901	7314150169016	1	90 l	1400-1870 mm	630 mm	413 mm	1000 mm	32 kg

**BOD8902****2 in 1 oil drainer with tank capacity 90L**

- 2 in 1 oil drainer used for gravity or suction (with vacuum venturi) draining of used oil from engines, gearboxes and differentials of all vehicles
- Includes a wide selection of various probes usable with a wide variety of vehicles, such as a copper probe for high temperature oil
- Flexible nylon: 5 x 700 mm, 6 x 700 mm, 7 x 1000 mm, 8 x 700 mm
- Rigid copper: 5 x 700 mm, 6 x 700 m
- Adaptors: for BMW, diameter 12.2 mm, and for VAG Group diameter 10 mm
- Suction rate: 1.5 to 2 l/min (oil at 70° and -80°C, with 6 mm probe and 8 bar/115 psi air pressure)
- Suction air pressure: 7-8 bar / 100-115 psi
- Maximum draining pressure: 1 bar / 14.5 psi
- Maximum draining and suction tank capacity: 90 l
- Reinforced connection between tank and oil tube to minimise the risk of leaks
- Swiveling offset funnel design for high flexibility with 18 litre capacity
- Metal reinforced hoses for improved durability
- Foam protected handle for insulation and to avoid scratches on vehicles in case of an accident
- Gauges indicating the level of contained liquid, air tank and suction pressures
- One swivel castor with brake for increased safety
- CE certified

BOD8902	7314150169023	1	90 l	1100-1700 mm	632 mm	413 mm	1000 mm	38 kg

**BOD8901AC1****Extension funnel for oil drainers**

- Simplifies positioning and capturing the used oil
- 60 cm extension
- For use with oil drainers: BOD8901, BOD8902 and BOD8903A

BOD8901AC1	7314150178490	1	400/600 mm	150 mm	620 mm	620 mm	620 mm	1.5 kg

**BOD2008****Oil drain tank**

- Used for easy oil and/or fluid draining
- Several handles and taps make it easy to transport the contained liquid to another larger tank for recycling
- Oil drain tank capacity: 8 l
- Made of polyethylene
- Withstands the most frequently used automotive products, except brake fluids
- Temperature range: -30°C to 70°C

BOD2008	7314150169986	1	8 l	590 mm	325 mm	115 mm	115 mm	0.88 kg

**BOD1016****Oil drain pan**

- Used for oil and/or fluid draining
- Several handles and taps make it easy to transport the contained liquid to another larger tank for recycling
- Oil drain pan diameter: 445 mm
- Oil drain pan capacity: 16 l
- Withstands the most frequently used automotive products, except brake fluids
- Temperature range: -30°C to 70°C

BOD1016	7314150169979	1	16 l	570 mm	450 mm	170 mm	170 mm	1.3 kg

**BE68****Carter wrenches**

- Carter wrenches with square tips
- Used for removing carter caps
- Available in two sizes
- BE68: 8-8 mm
- BE6810: 8-10 mm
- Hardness: 52-54 HRC
- High performance alloy steel
- Nickel & chrome plated finish

BE6810Z	7314150430765	12	8 in	10 mm	265 mm	265 mm	265 mm	342 g
BE6810	7314150237869	1	8 x 10 mm	- mm	270 mm	270 mm	270 mm	235 g



BE6217

Oil drain plug socket set

- This set includes 17 3/8" square drive bit sockets with different bits
- These bits are designed to suit a wide range of oil drain plugs
- XT-10 triangular and XZN M16 tamper
- Made of chrome vanadium
- Electroplated polished finish
- Supplied in a blow moulded case, in plastic inlay for better tool management
- All components are available individually

BE6217	7314150169702	1	3/8 in	220 mm	105 mm	55 mm	1.03 kg	



BOD10P64

Oil drain plug restorer set

- Provides an easy and quick way to restore damaged oil plug threads by tapping a new hole and installing a new plug
- Use the tap to enlarge the damaged thread and create a new profile, and install the new plug
- Includes sizes for the majority of car makes
- Set contents
- M13x1.5P tap + 5 screws + 10 copper washers
- M15x1.5P tap + 5 screws + 10 copper washers
- M17x1.5P tap + 5 screws + 10 copper washers
- M20x1.5P tap + 5 screws + 10 copper washers
- Supplied in a blow moulded case, in foam inlay for better tool management

BOD10P64	7314150205950	8	280 mm	225 mm	68 mm	1.58 kg



BOD4200/BOD4500

Oil cans

- Used for oil dispensing
- Features two ball valves for high volume delivery per stroke
- Bottom pump system increases durability and safety
- Capacity. BOD4200: 200 ml and BOD4500: 500 ml
- Body made of steel
- Powder coated finish
- Supplied with flexible and rigid spouts

BOD4200	7314150169436	1	0.2 l	128 mm	86 mm	158 mm	0.315 kg
BOD4500	7314150169443	1	0.5 l	128 mm	86 mm	158 mm	0.315 kg



BOD5400/BOD5450

Cartridge grease pump

- Universal grease pump with fixed extension and coupler
- Used for general lubrication purposes in automotive workshops
- Develops 413 bar maximum pressure
- Capacity: BOD5400 for 400 g cartridges, and BOD5450 for 450 g cartridges
- Features an air bleeder valve
- Sturdy construction
- Steel head structure
- Durable powder coated finish
- Ergonomic steel lever handle with rubber coating for better grip
- Barrel with non-slip surface
- Supplied with a grease loading fitting

					BAR	kg
BOD5400	7314150169450	1	55 x 120 x 390 mm	15,2 / 30,5 cm	413 bar	1.43 kg
BOD5450	7314150169474	1	65 x 125 x 385 mm	15,2 / 30,5 cm	413 bar	1.5 kg



BOD5HD400

Heavy duty cartridge grease pump

- Universal grease pump with flexible extension and coupler
- Designed for intensive daily use in heavy duty applications
- Develops 690 bar maximum pressure
- Capacity: 400 g cartridges
- Features a bulk loader and an air bleeder valve
- Heavy duty construction
- Robust barrel 1.2 mm thickness
- Aluminium die cast and precisely CNC machined gun head
- Ergonomic steel lever handle with rubber coating for better grip
- Barrel with non-slip surface
- Unique lock lever mechanism allows user to lock the plunger rod in any position
- Variable stroke feature enables use in confined areas
- Supplied with a grease loading fitting

					BAR	kg
BOD5HD400	7314150169467	1	60 x 115 x 360 mm	15,2 / 30,5 cm	690 bar	1.43 kg



BOD2FS

2L Can with flexible spout

- Features a long removable flexible spout in order to reach difficult access areas
- 2 litre capacity
- Volumetric scale for filling with the proper fluid amount
- Made of polyethylene; resistant to oil, chemicals, petrol and antifreeze fluids
- Translucent for quick view of remaining content
- Retail packed

								kg
BOD2FS	7314150351879	20	2 l	380 mm	130 mm	330 mm		0.216 kg

**BOD60****Lever action barrel pump**

- Lever hand operated heavy duty pump
- For continuous transfer of non corrosive fluids
- Suitable for oil based fluids (lubricants), heating oil, motor oil, heavy and light oils, transmission fluids, and other non-corrosive liquids
- Recommended for fluids with viscosity up to SAE90
- Powerful and time saver. Capacity/stroke: Up to 300 ml
- Features curved metal spout and telescopic suction tube to fit 50 litre to 205 litre barrels
- Heavy duty construction
- High quality powder coated steel pump body with ribbed section aluminium pump head for maximum strength
- Seals made of sturdy NBR
- Wear resistant brass piston rings
- Steel lever handle with rubber coating for better grip
- Built-in 1-1/2" and 2" bung nut for use on drums with either size opening
- Do not use for water based liquids, antifreeze, solvents, acids, gasoline, etc.

BOD60	7314150169481	1	245 mm	57 mm	875 mm	300 l	2.14 kg

**BOD70****Rotary barrel pump**

- For continuous transfer of non corrosive fluids
- Suitable and recommended for diesel, kerosene, heating oils, engine oils, lubricant oils and other non-corrosive fluids
- Recommended for fluids with viscosity up to SAE90
- Dual direction operation, which allows the pump to both empty and refill containers
- Capacity/rotation: 250 ml
- Heavy duty construction
- Pump body sturdy cast iron with precisely machined cast iron vanes for better draw and smoother delivery
- Seals made of sturdy NBR
- For 50 to 205 litre barrels with 1" thread
- Do not use for water based liquids, antifreeze, solvents, acids, gasoline, etc.

BOD70	7314150169498	1	1330 mm	250 mm	230 mm	5.40 kg

**BOD301200****Oil funnel**

- Used to pour oil into small containers
- The cleanest system for refilling containers
- Withstands the most frequently used automotive products, except brake fluids
- Funnel made of polypropylene
- Funnel diameter: 165 mm
- Flexible hose made of PVC
- Flexible hose length: 400 mm and 16 mm diameter

BOD301200	7314150169993	1	165 mm	165 mm	225 mm	0.195 kg

**BE66152A****Rubber belt wrench**

- Used to grip or tighten/loosen almost anything
- Easy adjustment to fit any circumference or irregular shape, up to Ø 150 mm
- Suitable for caps, screws, oil filters, exhaust pipes, pulleys, etc.
- Heavy duty construction
- Rubber belt length: 635 mm
- Belt available as a spare part [Ref. BE661521]
- Retail packed
- Rubber belt wrench

BE66152A	7314150492534	6	150 mm	220 mm	170 mm	95 mm		309 g

**BE611****Oil filter strap wrench**

- Removes oil filters by adjusting and tightening the strap around the filter
- High performance alloy steel
- Diameter range
- BE61110: 65-110 mm
- BE61155: 100-155 mm
- Larger sizes are suitable for heavy vehicle oil filters
- Straps are available as spare parts [Ref. BE61110-1 and BE61155-1]
- Retail packed

BE61110	7314150167449	12	65-105 mm	210 mm	55 mm	25 mm		295 g
BE61110-1	7314150167463	100	65-105 mm	382 mm	12 mm	1 mm		15 g
BE61155	7314150167456	12	100-155 mm	275 mm	75 mm	37 mm		315 g
BE61155-1	7314150167470	1	100-155 mm	529 mm	12 mm	1 mm		25 g

**BE62****Oil filter strap wrench with rubber handle**

- Removes oil filters by adjusting and tightening the strap around the filter
- Features a convenient rubber handle with a twist adjuster to make these servicing tasks easier and more pleasant
- High performance alloy steel
- Diameter range
- BE62110: 65-105 mm
- BE62155: 110-155 mm
- Straps are available as spare parts [Ref. BE61110-1 and BE61155-1]
- Retail packed

BE62110	7314150403332	10	65-105 mm	42.5 x 57 x 249 mm		258 g
BE62155	7314150403349	10	110-155 mm	42.5 x 85 x 314 mm		265 g

**BE64520/BE64350****Oil filter chain wrench**

- Chain provides maximum power for removing very stubborn filters
- PVC handle for a more comfortable grip
- Can be used in all directions
- High performance alloy steel
- Diameter range
- BE64350: 60 - 105 mm
- BE64520: 60 - 160 mm
- Chains available as spare parts [ref. BE64350CH and BE64520CH]
- Retail packed

BE64350	7314150169672	1	350 mm	35 cm	60-105 mm	45 x 25 x 240 mm	760 g
BE64520	7314150169665	1	520 mm	52 cm	60-160 mm	25 x 45 x 230 mm	870 g



BE60F108
Fuel filter cover wrench

- Specifically designed for working on fuel filter covers
- Suitable for HDi engines mounted in Citroën, Peugeot and some Renault vehicles
- Half-moon shape for unbeatable comfort
- Allows accurate installation torque
- Avoids damaging fuel filter housing
- Essential tool for engine maintenance tasks
- 108 mm diameter
- 3/8" drive
- Made of aluminium

BE60F108	7314150434572	50	3/8 in	108 mm	96 x 10 x 140 mm	110 g



BE1FFWF
Fuel filter wrench Ford 2.2TDCi

- Used to install and remove Ford 2.2TDCi fuel filters
- It is designed to avoid damaging the filter cartridge
- Ensures proper leak-free fuel filter installation
- Suitable for 2012 and later engines
- Drive: 1/2"
- High performance alloy steel
- Black plated finish
- Retail packed

BE1FFWF	7314150403325	12	5 x 142 x 169 mm	231 g



BE6302712F
27 mm oil filter wrench for Ford and PSA Group

- Ø27 mm bi-hex oil filter wrench
- Features a special shape that allows reaching hard to access oil filter nuts, avoiding interferences with the various parts of the vehicle, such as air ducts, engine parts, etc.
- Suitable for PSA Group, Ford and Jaguar oil filters
- The fastest and safest way to remove oil filters
- Application chart included on the package
- Drive: 1/2"
- High performance alloy steel
- Retail packed

BE6302712F	7314150412846	5	1/2 in	27 mm



BE63064514F1
Oil filter wrench Toyota, Lexus, Subaru, Daihatsu with 4 cylinders (1.8 to 2.0 litre)

- Ø64.5 mm and 14 flutes oil filter wrench
- Suitable for Toyota, Lexus, Subaru and Daihatsu cartridge type oil filters
- Features special tooth design that mates perfectly without slipping
- The fastest and safest way to remove oil filters
- Drive: 3/8"
- Made of forged aluminium that will not damage the plastic cap of the filter
- Anodised finish
- Retail packed

BE63064514F1	7314150340095	1	Toyota, Lexus, Subaru, Daihatsu 4 cylinders (1.8-2.0l)	64.5 mm	3/8 in	14	1	

BE63064514F2**Oil filter wrench Toyota, Lexus, Subaru, Daihatsu with 4, 6 or 8 cylinders (2.5 to 5.7 litre)**

- Ø64.5 mm and 14 flutes oil filter wrench
- Suitable for Toyota, Lexus, Subaru and Daihatsu cartridge type oil filters
- Features special tooth design that mates perfectly without slipping
- The fastest and safest way to remove oil filters
- Drive: 3/8"
- Made of forged aluminium that will not damage the plastic cap of the filter
- Anodised finish
- Retail packed

BE63064514F2	7314150340101	1	64.5 mm	Toyota, Lexus, Subaru, Daihatsu 4, 6, 8 cylinders (2.5 -5,7L)	3/8 in	14	1

BE6307414F**Oil filter cup 74 mm 14 flutes**

- Ø74 mm and 14 flutes oil filter wrench
- Suitable for Audi, BMW, Mercedes-Benz, Opel and Volkswagen cartridge type oil filters
- Features special tooth design that mates perfectly without slipping
- The fastest and safest way to remove oil filters
- Drive: 3/8"
- Made of forged aluminium that will not damage the plastic cap of the filter
- Anodised finish
- Retail packed

BE6307414F	7314150370108	10	1/2 in	74 mm	Audi, BMW, Mercedes-Benz, Opel, Volkswagen	14	1

BE630**Oil filter cup set**

- Set of cups for removing spin-on oil filters
- The fastest and safest way to remove oil filters
- Complete set for the vast majority of the European vehicle fleet: Fiat, Volvo, GM, Ford, Toyota, Mercedes, etc.
- Recommended by several vehicle manufacturers
- Set contents
- 28 different sizes/shapes oil filter cups
- 1x 3/8" to 1/2" adaptor
- 1x oil filter wrench with three flat jaws
- High performance alloy steel
- Application chart included
- Also available individually

BE630	7314150169580	3	610 mm	505 mm	87 mm	7.36 kg

BOD6080P12**Automatic transmission fluid refiller**

- Provides an easy and quick way to refill the fluid of automatic transmissions
- Equipped with hand vacuum pump to prevent oil deterioration
- 7.5 litre tank with graduation, pumping device and refilling hose
- Hose dimensions: 1/2" x 1.6 m
- Pump made of aluminium
- Fluid tank made of PP
- Set contents: 11 adaptors for different car makes such as Audi, BMW, Lexus, Mercedes, Mini Cooper, Nissan, Porsche, Skoda, Toyota, Volvo, VW, etc.
- Supplied in a blow moulded case, in foam inlay for better tool management

BOD6080P12	7314150235407	1	8 l	330 mm	255 mm	595 mm	4.33 kg



BE65F65120

3-jaw oil filter wrench

- Oil filter wrench with three flat jaws
- Flat jaws ensure a stable grip of all different kinds of oil filter
- Also increases accessibility to hard to reach areas
- High performance alloy steel
- Black phosphate finish
- Retail packed

BE65F65120	7314150169658	12	3/8 in	65-120 mm	80 mm	80 mm	63 mm	0.385 kg	



BE65R65120

Magnetic 3-jaw oil filter wrenches with opening width from 65 to 120 mm

- Oil filter wrenches with magnetic adhesion
- Opening width from 65 to 120 mm
- Provide increased control when tightening/loosening oil filters
- Rifled jaws for increased grip on the oil filter
- High performance alloy steel
- Retail packed

BE65R65120	7314150170012	1	3/8-1/2 in	65-120 mm	21 mm	85 mm	85 mm	85 mm	0.56 kg	



BE65R80120

Magnetic 3-jaw oil filter wrenches with opening width from 80 to 120 mm

- Oil filter wrenches with magnetic adhesion
- Opening width from 80 to 120 mm
- Provide increased control when tightening/loosening oil filters
- Rifled jaws for increased grip on the oil filter
- High performance alloy steel
- Retail packed

BE65R80120	7314150170029	1	3/8-1/2 in	80-120 mm	21 mm	90 mm	90 mm	75 mm	0.6 kg	



BE65R106160

Magnetic 3-jaw oil filter wrenches with opening width from 106 to 160 mm

- Oil filter wrenches with magnetic adhesion
- Opening width from 106 to 160 mm
- Provide increased control when tightening/loosening oil filters
- Rifled jaws for increased grip on the oil filter
- High performance alloy steel
- Retail packed

BE65R106160	7314150170036	1	1/2 in	106-160 mm	21 mm	120 mm	120 mm	81 mm	1.33 kg	



UNDER CAR





BWTDG1

Digital tyre tread depth gauge

- Digital gauge for measuring tyre tread depth
- Depth measuring range covering cars, SUVs and a wide range of heavy duty vehicles: 0-25 mm
- It is crucial to check the tread depth because it is directly related to the safety of the passengers of any vehicle
- Special tip for precise measurement of the tread depth
- Accuracy: ±0.03
- Made of stainless steel
- Auto-off feature
- High-resolution LCD display for convenient readings
- LR44 battery included
- Supplied in a sturdy plastic box with foam inlay to protect the device
- CE certified according to EN 61326-1:2013

BWTDG1	7314150403400	50	0 - 25 mm	30 x 76 x 156 mm	210 g



BWTB12P5

Set of 5 torsion bars with 1/2" drive designed for tightening wheel nuts with an impact wrench without exceeding the recommended torque

- Designed for tightening wheel nuts with an impact wrench without exceeding the recommended torque
- Colour coded ring for easy identification of the maximum torque of each bar: Green: 90Nm / Black: 100Nm / Gold: 110Nm / Red: 120Nm / Blue: 135Nm
- We recommend always using a torque wrench to adjust the final specified tightening torque
- Drive: 1/2" drive
- Black phosphate finish
- High performance alloy steel
- Hardness: 40-48 HRC
- Supplied in a blow moulded case, in plastic inlay for better tool management
- Also sold individually

BWTB12P5	7314150329991	1	68 x 225 x 280 mm	1.74 kg

BWTB12P90, BWTB12P100, BWTB12P110, BWTB12P120, BWTB12P135

29-B/BWXW1/BWXW2

Wheel wrenches

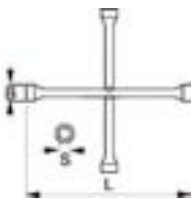

- Heavy duty four-way wheel wrenches
- Different models with different dimensions and for different application
- High performance alloy steel
- Hardness: 43-48 HRC
- Chrome plated finish
- Compliant with
- ISO 6788
- DIN 3119
- UNE 16518

			S	B	L					
BWXW1	7314150167661	1	17, 19, 22 mm	26, 28, 31 mm	380 mm	1/2 in	380 mm	31 mm	380 mm	6.2 kg
BWXW2	7314150167678	4	24, 27, 32 mm	36, 40, 45 mm	695 mm	3/4 in	695 mm	45 mm	695 mm	4.56 kg
BWXW3	7314150214624	1	17, 19, 21, 22 mm	25, 27, 29, 31 mm	378 mm		378 mm	30 mm	378 mm	1.27 kg
BWXW4	7314150214631	1	24, 27, 32, 38 mm	35, 40, 46, 52 mm	695 mm		695 mm	52 mm	695 mm	4.71 kg



38A
Tyre levers

- Ideal for tyre removal
- Flat pattern with hooked ends
- Various lengths available, from 304 to 650 mm
- Suitable for motorbikes, passenger cars and light commercial vehicles
- Very sturdy construction, yet light and comfortable
- Hardness: 40-48 HRC
- High performance chrome vanadium steel
- Nickel & chrome plated finish
- Retail packed

38A-12	7314150237944	1	304 mm	245 g
38A-15	7314150237951	25	382 mm	385 g
38A-21	7314150237968	1	537 mm	895 g
38A-26	7314150237975	1	655 mm	1.155 g



38C
Tyre lever for commercial vehicles and trucks

- Ideal for tyre removal
- Features specific curved tip design suitable for commercial vehicles and trucks
- Very sturdy construction, yet light and comfortable
- Hardness: 40-48 HRC
- High performance chrome vanadium steel
- Nickel & chrome plated finish
- Retail packed

38C-26	7314150237982	1	645 mm	1.135 g



39-24
Tyre lever, special bent form

- Heavy duty tyre lever
- Ideal for tyre removal
- Features specific bent design suitable for commercial vehicles and trucks
- Very sturdy construction, yet light and comfortable
- High performance chrome vanadium steel
- Lacquer finish
- Retail packed

39-24	7314151831301	1	605 mm	1300 g

BWTPMSS4C
Tyre nozzle deflation caps



- Used to identify each wheel to avoid missing the TPMS sensor position when changing the wheel
- Time saver. Allows the user to deflate the tires without wasting so much time
- Safe. Helps to avoid damaging the sensor when deflating
- Made of anodised aluminium, colour coded and marked
- FL (front left) - Blue
- FR (front right) – Dark Grey
- RL (rear left) - Green
- RR (rear right) - Red
- Different colours makes caps easily visible on most rims or wheels
- Knurling provides a sure grip even in greasy situations
- Supplied in a plastic injection case, in foam inlay for better tool management

BWTPMSS4C	7314150347100	25	108 mm	59 mm	27 mm		60 g



BWTMSS9

Tire pressure monitoring system maintenance tool set



- Used to avoid damaging the tire pressure sensors when replacing them
- Applies a reliable controlled torque to TPMS valves
- Ideal configuration for proper assembly and disassembly of standard TPMS and associated special tyre valves
- Set contains all necessary tools for avoiding damage to threads and sensors, and for ensuring a secure threaded connection and seal
- Adjustable calibrated torque wrench (1 - 6 Nm) covers most common tightening torques
- 1/4" drive 1-6 Nm torque screwdriver [ref. TSS600] for tightening the sensor at the manufacturer's specified value
- 1/4" T bar
- 1/4" 11 & 12 mm hex 12-pt sockets
- 1/4" Torx bits T10-T15-T20 50 mm long
- 1/4" hex bit holder
- Tire valve core tool with 0.45Nm max torque [ref. BWTVCTT355]
- Supplied in a blow moulded case, in foam inlay for better tool management

BWTMSS9	7314150347124	8	225 mm	225 mm	68 mm	1049 g



BWTVCTT355

Tire valve core tool with 0.45 Nm max torque

- Designed for removing and accurately installing valve cores
- The tool is preset to 0.45 Nm and prevents overtightening or undertightening of TPMS valves with sensors
- Preset torque setting also helps prevent air leaks that lead to low tire pressure and TPMS alerts

BWTVCTT355	7314150347179	1	0.45 N-m	0.33 lbf-ft	4.0 lbf-in	40 g



BWP150

Wheel balancing pliers

- Used to remove wheel balancing weights
- The specific shape perform several functions such as removing or attaching wheel balancing weights on rims, etc.
- Handle with PVC hand protection
- High performance chrome vanadium steel
- Chrome electroplated finish
- Retail packed

BWP150	7314150170159	1	255 mm	87 mm	20 mm	0.425 kg



BBR202P4

1/2" pentagon socket and bit set for hand brake

- Used for adjusting and installing most Girling and Bendix hand brake systems
- Set contents
- Pentagon sockets: 10 mm, 14 mm and 19 mm
- Socket bit holder: 10 mm
- Drive: 1/2"
- Complete set for the vast majority of the European vehicle fleet
- Can be easily used with a pneumatic ratchet
- High performance alloy steel
- Black phosphate finish
- Parts list included in the case
- Supplied in a blow moulded case, in foam inlay for better tool management

BBR202P4	7314150205769	1	43 x 90 x 200 mm	0.5 kg



4480/

Tube cutter and double flaring tool set

- For double or single flares on soft steel, brass or aluminium tubes
- Double flaring adapter: 3/16", 1/4", 5/16", 3/8" and 1/2"
- Set includes tube cutter, flaring bar, rod handle, yoke and adaptors
- Tailored plastic case and cavities

4480/2-ZD	7311518276911	1	330 mm	140 mm	45 mm	1650 g



BBRBB12

12V Electrical brake bleeder

- Selectable pulse and continuous bleeding modes to suit the requirements of all car manufacturers
- Suitable for DOT3, DOT4 and DOT5.1 brake fluids
- One-person operation machine: It gives more efficiency in the workshop
- Connection on vehicle's 12V battery
- Permissible pressure from 0.2 bar to 3.5 bar for both bleeding modes
- Pressure easily adjustable with the potentiometer
- Heavy duty bleeding pump
- Safety features
- Buzzer for reverse polarity connection and low brake fluid level
- The internal movable switch will never allow air to penetrate into the device and therefore into the vehicle brake system
- 6A fuse protects the main switches, pump and device electronics
- Stainless steel body protects against corrosive workshop fluids
- Quick connections with anti-return system
- 4.6 metre cable with insulated clamps of 20 mm opening width
- Supplied with an E20PW adaptor and a 1 litre bottle for used fluid
- 10 litre tank for fresh brake fluid with a sight gauge for brake fluid level in the tank
- Optimal operating temperature: 10°C < T < 30°C
- CE certified and marked with individual serial number

BBRBB12	7314150371297	1	895 x 390 x 395 mm	12 V	4600 mm	X	0.2-3.5 bar	6 A	14.6 kg



BBRAS14

Brake bleeder master cylinder cap adapter kit

- Master cylinder adaptor set for efficient brake system maintenance tasks
- This set includes 11 adaptors for the most popular European makes, including BMW, Mercedes-Benz, PSA Group, Renault, etc., as well as Japanese and American makes such as Toyota, Honda, GM, etc.
- Quick connector type: PN5
- To be used with our BBRBB12
- These adaptors ensure perfect sealing
- Made of durable injection-moulded PA with glass fibre reinforcement
- Application chart included
- All items available individually
- Supplied in a blow moulded case, in foam inlay for better tool management

BBRAS14	7314150416943	4	PN5 in	85 x 350 x 445 mm	3.1 kg

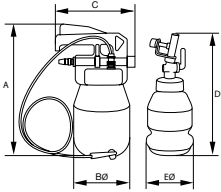

BBR350

Air brake system bleeder

- Pneumatic brake fluid bleeder
- Allows a fast and efficient air-operated brake bleeding procedure
- Universal rubber bleed nipple suitable for any brake system
- Features a high capacity steel valve for large volume delivery per stroke
- Quick release locking trigger
- Container capacity: 1.5 L
- Refill reservoir capacity: 0.6 L
- Bleeder hose length: 2 m
- Durable construction
- Quick instructions included
- Packed in a cardboard box

					A	B	C	D	E		
BBR350	7314150169900	1	1/4" in	300 x 125 x 125 mm	301 mm	131 mm	185 mm	275 mm	111 mm	2000 mm	1.71 kg



BBR405

Digital brake caliper

- Digital callipers for precise measurement of brake disk/drum diameter and thickness
- Diameter measuring range covers standard cars, SUVs and light commercial vehicles: 0-300 mm
- Special tips for precise measurement
- Internal and external measurements thanks to double tips
- Accuracy ± 0.05
- Made of stainless steel
- Choice of metric and imperial measurements
- Auto-off feature after 7 minutes
- LR44 battery included
- Certified according to 2014/30/EU - 2011/65/EU
- Supplied in a protective plastic box

				L	
BBR405	7314150435807	20	37 x 155 x 460 mm	0-300 mm	998 g



BBR420

Digital caliper for brake discs

- Digital caliper for measuring brake disc thickness
- Thickness measuring range covers cars, SUVs, and a wide range of heavy-duty vehicles: 0–60 mm
- It is crucial to check brake disc thickness because this is directly related to the safety of the passengers of any vehicle
- Special tips for precise thickness measurement
- Accuracy: ± 0.03 %
- Made of stainless steel
- Auto-off feature
- High-resolution LCD display for convenient readings
- LR44 battery included
- Supplied in a sturdy plastic box with foam inlay to protect the device
- CE certified according to EN 61326-1:2013

				L	
BBR420	7314150403394	50	35 x 104 x 176 mm	0 - 60 mm	298 g



1150D

Precision measuring digital callipers with LCD screen

- Stainless steel
- Digital display with LCD screen
- Measures mm and inch range from 0 to 150 mm or 6" with an increment of 0.01 mm or 0.0005" respectively
- Accuracy ± 0.03 mm
- Resolution 0.01 mm
- Supplied in protective box
- Depth gauge including limit and peak measurements
- Automatic turn off

1150D	7311518276614	1	25 x 90 x 245 mm	235 mm	150 mm	320 g



BBR400

Aluminium caliper

- Caliper for accurate and reliable measurement of brake disc thickness
- Retractable jaws for easy removal of the caliper from the disc, retaining the reading
- It also works as a tyre tread depth gauge
- Measuring range: 0 - 60 mm
- Metric scale with 1 mm graduations
- Made of anodized aluminium
- Retail packed

BBR400	7314150345939	1	6 x 89 x 120 mm	0 - 60 mm	0.045 kg



BBR410

Caliper for measuring brake disc and brake shoe diameters

- Caliper for accurate and reliable measurement of brake disc thickness and brake shoe diameter
- Measuring range: 160 - 365 mm
- Metric and Imperial scale
- Heavy duty construction for high impact resistance, suitable for tough jobs
- Made of alloy steel
- Retail packed

BBR410	7314150345946	24	20 x 210 x 280 mm	160 - 360 mm	0.610 kg



783

Brake brush, steel

- Used to clean brake discs and drums
- Two rows of stainless steel bristles
- Plastic handle
- Retail packed

783	7311518276034	1	223 mm	95 mm	65 g



BBRPTG1

Brake pad thickness gauge

- Eight coloured gauges that can be used without removing the calliper assembly in many cases
- Time-saver product
- Thickness measuring range 2 to 12 mm
- Designed with intuitive colour coding
- Red = replace immediately
- Yellow = OK but should be replaced soon
- Green = OK, no action necessary
- With mm and inch indication on each wear gauge
- Made of anodized aluminium
- Retail packed

BBRPTG1	7314150412617	10	68 g

BBR204

Hand brake cable pliers



- This tool allows quick and easy assembly and disassembly of the hand brake cable by compressing the retaining spring
- Special tips for easy fitting of hand brake cable retaining spring
- Opening width 21.9 mm
- Suitable for a wide range of vehicles, such as VAG Group, BMW, PSA Group, Nissan, Renault, etc.
- Knurled grip metal handles
- Time saver tool
- High performance alloy steel

BBR204	7314150430635	6	21,9 mm	16 x 71 x 235 mm	235 mm	172 g



BBR6135

Brake spring pliers with pivoting head

- Brake spring pliers with pivoting head
- Used to install and remove brake springs
- Features a special holder and support crown, particularly suitable for glued and riveted brake linings
- High performance alloy steel
- Handle with PVC hand protection
- Nickel & chrome plated finish
- Retail packed

BBR6135	7314150239450	1	20 x 90 x 430 mm	335 mm	480 g

1154

Micrometer with magnetic base

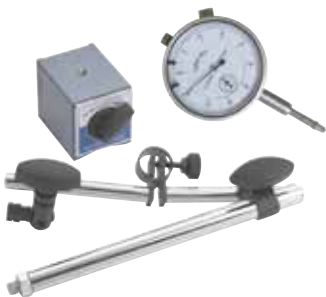

- Used to check flatness of brake discs
- The holder, equipped with a magnetic base, will grip flat or even curved metal surfaces
- Dial indicator measuring precision: 0.01 mm
- Dial indicator measuring range 0-10 mm
- Complies with ISO463 and DIN878 standards
- Set contents
- Square magnetic base with fixed 178 mm bar, total length 250 mm
- 150 mm flexible arm that can be fixed at any position of 360° in X and Y axis
- A dial indicator that can be fixed to the flexible arm at any position [ref. 1154-DG]
- Retail package, foam protected to prevent damage

1154	7314150249831	1	230 x 50 x 75 mm	0 - 10 mm	0.01 mm		1.5 kg

1154-DG

1154-MB





BBR100
Brake fluid tester pen

- Used to check brake fluid quality by measuring its moisture content
- Suitable for brake fluids DOT3, DOT4 and DOT5.1
- Quick reading (1s) of moisture concentration: 2%: Medium; >3%: Needs to be changed
- Automatic shut-off function after 20 s without use
- Powered by an AAA 1.5V battery supplied with the tester
- Retail packed

BBR100	7314150345922	1	25 > X > 32 °C	0 > X > 50 °C	2000 MAX m	0-85 %	20 x 20 x 150 mm	0.055 kg



BBR300P50
Universal brake caliper tool set 50 pieces

- Designed for rewind and push-back brake pistons
- An essential 50 tool set for caliper servicing
- It makes brake pad replacement quick and easy on most of European and Japanese cars
- Supplied with a vehicle application chart
- Left- and right-hand thread pitch included
- Supplied in a blow moulded case, in foam inlay for better tool management

BBR300P50	7314150269624	4	82 x 350 x 425 mm	5.56 kg



BBR320
Brake caliper wind-back air tool

- Used to push and turn brake pistons
- Works in both directions: left and right
- 3/8" square drive
- Quick and safe to use
- Includes a 1/4" adaptor for use with BBR300P50 Bahco caliper set
- CE certified

BBR320	7314150169887	1	3/8 in	1/4" in	200 x 70 x 260 mm	1.07 kg



BBR201P6
XZN 1/2" impact socket bit set for brakes



- For use when servicing and working on the brake system using power tools
- Set contents
- 40 mm long sockets: M14, M16 and M18
- 78 mm long sockets: M14, M16 and M18
- Drive: 1/2"
- Hardness: 50-55 HRC
- High performance alloy steel
- Black phosphate finish
- Parts list included in the case
- Supplied in a blow moulded case, in foam inlay for better tool management
- Sold individually

BBR201P6	7314150205752	8	68 x 225 x 225 mm	1.07 kg

BBR201P67814, BBR201P67816, BBR201P67818, BBR201P64018, BBR201P64014, BBR201P64016





BBR203P9

Torx® 1/2" impact socket bit set for brakes



- For use when servicing and working on the brake system using power tools
- Set contents: T20, T25, T27, T30, T40, T45, T50, T55, T60
- Drive: 1/2"
- Length: 78 mm
- High performance alloy steel
- Black phosphate finish
- Parts list included in the case
- Supplied in a blow moulded case, in foam inlay for better tool management
- Sold individually

BBR203P9	7314150208081	1	68 x 225 x 225 mm	1.23 kg

BBR203P925, BBR203P960, BBR203P930, BBR203P927, BBR203P920, BBR203P945, BBR203P955, BBR203P940, BBR203P950



BPCVB1

CV boot installation pneumatic tool

- Used to stretch flexible CV boots onto driveshaft assemblies
- Easy operating. Time and effort saver
- Operating pressure: 5 - 8 bar
- To be connected to a pneumatic system with a 1/4" BSP fitting
- Housing material: PA6 and glass fibre
- It can also be used with BPOC15 and/or BE251200 pliers
- CE certified according to Directive 2006/42/EC

				BAR				
BPCVB1	7314150384792	6	25-110 mm	5-8 bar	455 mm	138 mm	138 mm	2.053 kg



BWB14

Wheel bearing tool set

- Bearing removal set for various bearings and seals
- Universal set suitable for the majority of the European vehicle fleet
- Set includes
- 9 adaptors from Ø 55.5 to 84 mm
- 1 cage – lining 76 mm
- 2 cages, 86 and 91 mm
- 1 puller, 38 mm
- 1 centre axle with screw and pin
- Supplied in a blow moulded case, in plastic inlay for better tool management

BWB14	7314150170166	2	525 mm	300 mm	80 mm	8.02 kg



BT20P49

Hydraulic bearing removal and installation set

- For removal and installation of various bearings, ball bearings and seals, from Ø18 to Ø60 mm
- Powered by a hydraulic cylinder actuated with a hand or foot pump
- Contents
- - 18.2 T max. capacity hydraulic cylinder
- - 44 short and long pressure bushings with different diameters, from Ø18 to Ø60 mm
- - 4 different diameter spindles. Ø10, Ø12, Ø14 and Ø16 mm
- Hydraulic spindle thread: PT 3/8"-19
- Adaptor thread: M24.5×P1.25
- Supplied in a blow moulded case, in plastic inlay for better tool management

BT20P49	7314150385041	1	890 mm	520 mm	164 mm	30600 g



BS52
Steering arm inner tie rod removal tool set

- Used to easily replace most type of inner tie rods of cars as well as light commercial vehicles
- Thanks of the 3 models of adaptable cages this tool covers the largest range of different shapes and sizes of tie rod heads from a diameter of 28 mm to 45 mm
- Functional, compact and easy to use
- The 3 cages are colour coded for easy identification of the individual diameter range:
 - Red: for tie rods Ø28-34 mm [Ref. BS5228341]. Maximum torque: 80 Nm
 - Blue: for tie rods Ø34-40 mm [Ref. BS5234401]. Maximum torque: 100 Nm
 - Green: for tie rods Ø39-45 mm [Ref. BS5228341]. Maximum torque: 150 Nm
- Supplied in a blow moulded case, in plastic inlay for better tool management

BS52	7314150329212	1	110 x 315 x 380 mm	3.08 kg



BWHPJ12
Ball joint extractor set with 12T hydraulic spindle

- Specially designed for ball joint extraction
- Heavy duty construction. Suitable for a wide range of vehicles, from passenger cars to heavy duty
- Useful operating range with 70 mm open capacity and 36 mm width
- Set includes
 - BWHPJ12-01. High performance forged alloy steel
 - BWHEHS. 12T hydraulic spindle with 17 mm stroke
- Provides smooth extraction
- 1-1/2" - 16 UN thread
- See individual descriptions for each component of the set

BWHPJ12	7314150403257	4	12 to	70 mm	4.79 kg



4545-N
Universal ball joint pullers with galvanized finish

- Made of special steel
- Galvanised finish
- Used for unassembled ball joints in automotive applications
- Application: Special tool for removing ball pins during dismantling of ball joints on tie-rods on cars and trucks
- 4545-N1 For cars Audi, Alfa-Romeo, BMW, Citroen, Fiat, Ford, Honda, MB, Opel, Peugeot, Renault, Saab, Seat, Skoda, Volvo, VW
- 4545-N11 For vans and medium trucks MB (Atego up to 17t), MAN (M2000), Iveco, Renault, Scania, Volvo, DAF
- 4545-N1/S Spindle for 4545-N1
- 4545-N2/S Spindle for 4545-N2
- 4545/S Spare pressure spindle
- A special tool for removing ball pins during dismantling of ball joints on tie-rods

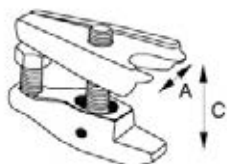

			A	C						
4545-N1	7314151722432	1	18-22 mm	Max 50 mm	70 N-m	3.5 to	35 kN	M14x1.5x35 mm	19 mm	630 g
4545-N11	7314150249169	1	27-36 mm	Max 90 mm	200 N-m	10 to	100 kN	G1/2"x14x110 mm	22 mm	4500 g
4545-N2	7314151804947	1	26 mm	Max 50 mm	40 N-m	3.5 to	35 kN	M16x1.5x70 mm	17 mm	1310 g
4545-N21	7314150249176	1	26 mm	60-80 mm	40 N-m	3.5 to	35 kN	M16x1.5x90 mm	17 mm	1800 g

4545/S: Spare spindle



BS40VAG
Camber adjusting tool

- Adjust the camber by placing the tool between the rim and the body
- Turning the hexagonal body increases or decreases the spacing to adjust the camber
- Suitable for VAG Group vehicles
- One-man tool
- Time saver tool
- External drive hex socket 22 mm, 85 mm length
- High performance alloy steel

BS40VAG	7314150430642	20	22 mm	52 x 92 x 150 mm	0.652 kg



BWHEPSSH8
Wheel hub plate with slide hammer and hydraulic spindle

- Specially designed for wheel hub extraction
- Suitable for extracting 3, 4 and 5 wheel hub studs
- Set includes
- BWHEHS: 12T hydraulic spindle with 17 mm stroke
- BWSH8: 960 mm long 8 kg mass slide hammer, allows you to pull with force
- BWHEP: Wheel hub plate, including five centring washers with 14 mm inner diameter
- Useful operating range with 116 to 135 mm hole circle
- See individual descriptions for each component of the set

BWHEPSSH8	7314150264896	1	960 x 100 x 180 mm	12 to	960 mm	#4-5/116-135 mm	15.8 kg		



BT20P26
Bearing removal and installation set

- Bearing removal and installation set for various bearings, ball bearings and seals
- Uniquely designed with a U-shape on every sleeve, which enables the mechanic to easily watch the work process
- This design ensures that the bearings are always installed in the right position
- Set includes
- 4 different dimension spindles (M10x1.5 - M12x1.75 - M14x2 - M16x2)
- 20 sleeves with different diameters
- 2 plate discs for presses
- Supplied in a blow moulded case, in plastic inlay for better tool management

BT20P26	7314150205820	1	535 mm	310 mm	150 mm		18.27 kg



BS25
Suspension arm lever bar

- Designed for pulling down the lower suspension arm in order to disassemble the hub joint
- Also suitable for separating the lower ball joint or suspension struts from the hub joint
- It achieves 20Nm pulling force, enough for working with a wide range of standard cars and light commercial vehicles
- “One-person operation device” that saves time and resources
- The flexible and adaptive design fits into the vehicle in seconds
- It provides increased safety, minimising the risk of injury
- Features a non-slip rubber pad
- Spare parts available
- Made of high performance alloy steel

BS25	7314150416103	1	20 N-m	200 kg	175 x 120 x 995 mm		4.02 kg

BS30PG

Double pneumatic piston shock absorber compressor with protective screen



- MacPherson spring compressor with double pneumatic piston system
- 24,000 N maximum compression capacity
- Protective screen included to increase safety by absorbing potential spring impacts
- It can compress more than 95% of the springs in the market, from light vehicles to 4x4
- Working pressure: 5-10 atm
- Cylinder stroke: 300 mm
- Opening width between jaws: 450 mm
- It is supplied with 4 equal claws and 1 different claw, with thinner profiles and completely independent of each other, for greater versatility.
- Easy and quick operation
- Completely safe
- - New protective screen
- - Spring anti-slip steel cable
- - Safety valve prevents use without protection
- - Shock absorber holder
- - Larger base to avoid tilting and provide more stability
- BS30AC1 height extension available as an option to provide 34 cm greater tool length and improve movability with two rubber wheels
- BS10AC2 Universal shock absorber blocking plate
- CE certified

BS30PG	7314150436644	1	1180 x 500 x 625 mm	24 kN		82.4 kg

BS30AC1

Moving height extension



- For being used with the BS30 and BS30PG
- Raises the working height of the BS30 by 34 cm
- Easy to assemble on the compressor with only four nuts attach the feet

BS30AC1	7314150383504	1	336 mm	545 mm	450 mm	8.18 kg

BS15

MacPherson spring compressor



- MacPherson spring compressor
- Maximum compression capacity: 1 T
- Can be used for both straight and conical springs
- Maximum spring working range: 300 mm
- The 24 mm hex head can be operated manually or with an air tool
- Set contents:
- Device/piston [Ref. BS1540]
- 3 pairs of jaws with plastic covers [Ref. BS15125, BS15160, BS15212] to avoid damage to the spring
- Small adaptor for conical springs [Ref. BS1550]
- Universal, covers 90% of the vehicle fleet thanks to the 3 different sizes of the jaws provided
- Jaws working range
- BS15125 : 80 - 115 mm
- BS15160: 110 - 150 mm
- BS15212: 140 - 195 mm
- Jaws equipped with spring protectors
- All components are available individually
- Supplied in a blow moulded case, in plastic inlay for better tool management

BS15	7314150206117	1	510 mm	425 mm	125 mm	1000 kg	15.20 kg

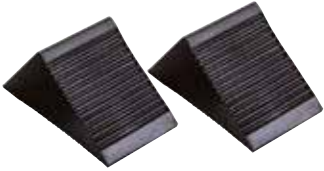

BWC1

Wheel chocks

- Wheel chocks for securing vehicles up to 4T on inclined surfaces
- They can also be used to prevent vehicle movement in the workshop while lifting them
- The solid rubber material and gridded support surface ensure optimal slip resistance
- Supplied in pairs
- ROHS certified
- Retail packed

BWC1	7314150365586	25	110 mm	77 mm	75 mm	0.655 kg

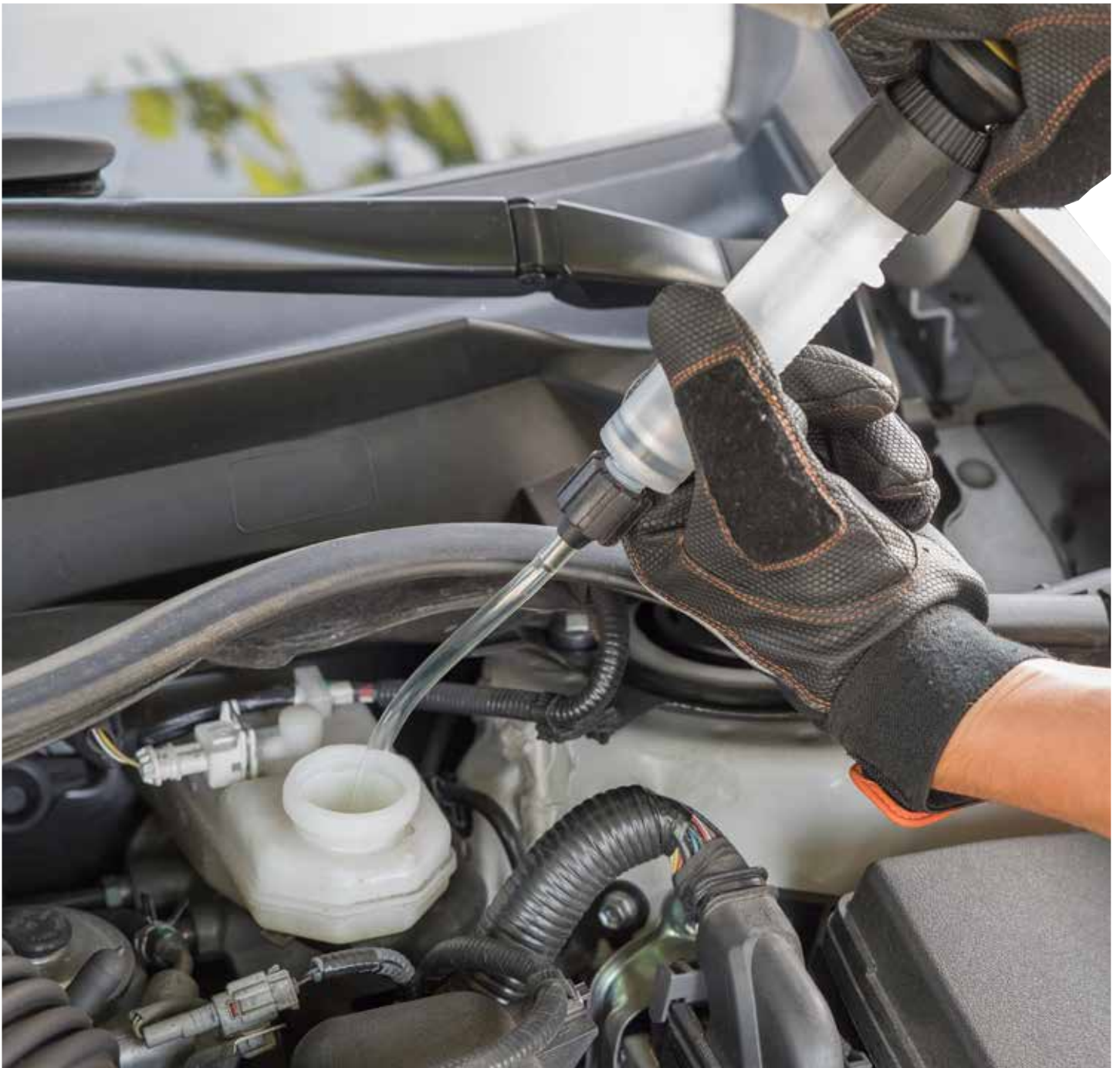



AIR TOOLS





BPC815K2

1/2" square drive impact wrench set with 5 metric sockets

- 1 BPC815
- 5 impact sockets: 13, 17, 19, 22, 24
- Supplied in a sturdy blow moulded case with foam inlay

BPC815K2	7314150331215	1	1/2 in	320 mm	230 mm	90 mm	3.54 kg	

BPC815		
K7801M-13, K7801M-17, K7801M-19, K7801M-22, K7801M-24		



BPC813

1/2" square drive micro impact wrenches with twin hammer mechanism

- 1/2" pneumatic micro impact wrench for confined workspaces
- Light, durable aluminium housing with rubber covered top and handle
- Powerful compact twin hammer mechanism
- Easy one-hand forward and reverse change
- Three-step power regulator
- 360° swivel connection to avoid hose coiling
- Progressive trigger mechanism
- Built-in silencer

				BAR											
BPC813	7314150296408	10	1/2 in	6,3 bar	1/4 in	10 mm	113 l/min	407 N·m	678 N·m	10000 min	1518	87 dBA	4,9 m/s ²	120 mm	1.54 kg



BPC814

1/2" composite impact wrenches with twin hammer mechanism 338 n.m

- Very compact and fast 1/2" pneumatic impact wrench
- Light, durable and insulated composite housing
- Powerful twin hammer mechanism
- Easy one-hand forward and reverse change
- Three-step power regulator
- 360° swivel connection to avoid hose coiling
- Progressive trigger mechanism
- Built-in silencer

				BAR											
BPC814	7314150296392	10	1/2 in	6,3 bar	1/4 in	10 mm	113 l/min	338 N·m	624 N·m	12000 min	1500	87 dBA	7,4 m/s ²	142 mm	1.24 kg



BPC815

1/2" composite impact wrenches with twin hammer mechanism 786 n.m

- 1/2" pneumatic impact wrench
- Light, durable and insulated composite housing
- Powerful twin hammer mechanism
- Easy one-hand forward and reverse change
- Power regulator
- One-hand forward/reverse change
- Three-step power regulator
- 360° swivel connection to avoid hose coiling
- Progressive trigger mechanism
- Built-in silencer

				BAR											
BPC815	7314150296385	1	1/2 in	6,3 bar	1/4 in	10 mm	113 l/min	786 N·m	1112 N·m	8000 min	1250	88 dBA	7,7 m/s ²	187 mm	1.98 kg



BPC817

3/4" square drive impact wrenches with twin hammer mechanism

- 3/4" pneumatic impact wrench
- Light, durable and insulated composite housing
- Powerful twin hammer mechanism
- Easy forward and reverse change
- Three-step power regulator
- 360° swivel connection to avoid hose coiling
- Progressive trigger mechanism
- Built-in silencer

				BAR											
BPC817	7314150296422	4	3/4 in	6,2 bar	3/8 in	10 mm	198 l/min	1627 N·m	2034 N·m	5000 min	916	96 dBA	11,6 m/s ²	220 mm	3.44 kg



BP901

1" square drive impact wrenches with durable rocking dog mechanism

- Extremely strong machine, 2550Nm in forward and 3500 in reverse
- Low noise and low vibration
- Durable rocking dog mechanism
- Three-step power regulator
- Comfortable support handle included

				BAR											
BP901	7314150336012	1	1 in	6.2 bar	1/2" in	13 mm	460 l/min	2550 N·m	3500 N·m	3800 min	400	87.5 dBA	6.17 m/s ²	409 mm	11.9 kg



BP901L

1" square drive impact wrenches with durable rocking dog mechanism and 9" anvil

- Impact wrench 1"
- Extremely strong machine, 2550Nm in forward and 3500 in reverse
- Low noise and low vibration
- Durable rocking dog mechanism
- Three-step power regulator
- Comfortable support handle included
- 9" anvil to reach every nut

				BAR											
BP901L	7314150336029	1	1 in	6.2 bar	1/2" in	13 mm	460 l/min	2550 N·m	3500 N·m	3800 min	400	87.5 dBA	6.17 m/s ²	587 mm	13.3 kg



BP700
1/4" mini air ratchets with power regulator

- Light, durable and insulated composite housing
- Progressive lever mechanism
- Power regulator in handle
- Forward and reverse change at the ratchet head

				BAR										
BP700	7314150134458	20	1/4 in	6.3 bar	1/4" in	10 mm	65 l/min	0-30 N·m	300 min	94 dBA	3.60 m/s ²	133 mm	0.52 kg	



BP821
1/2" ratchets with rubber grip

- Rigid housing covered with insulated rubber grip
- Easily adjustable power regulator in the handle
- Easy direction change switch
- 360° swivel connection to avoid hose coiling
- Progressive lever mechanism
- Built-in silencer

				BAR										
BP821	7314150134472	1	1/2 in	6.3 bar	1/4" in	10 mm	120 l/min	0-67 N·m	150 min	80 dBA	2.60 m/s ²	260 mm	1.20 kg	



BP115
Angle die grinders with rubber grip

- Die grinder 6 mm, angled
- Rigid housing covered with insulated rubber grip
- Easily accessible air regulator at end of handle
- 360° swivel connection to avoid hose coiling
- Progressive lever mechanism with safety trigger
- Includes one 3 mm collet

			BAR										
BP115	7314150134991	1	6.3 bar	1/4" in	10 mm	113 l/min	20,000 min	79 dBA	<2.5 m/s ²	164 W	170 mm	0.60 kg	



BP822
Die grinders with rubber grip

- Rigid housing covered with insulated rubber grip
- Easily accessible air regulator at end of handle
- 360° swivel connection to avoid hose coiling
- Progressive lever mechanism with safety trigger
- Includes one 3 mm collet

			BAR										
BP822	7314150134984	1	6.3 bar	1/4" in	10 mm	170 l/min	25,000 min	85 dBA	<2.5 m/s ²	250 W	165 mm	0.50 kg	



BP822E
Air die grinders with 6 mm shank, long anvil and rubber grip

- Rigid housing covered with insulated rubber grip
- Easily accessible air regulator at end of handle
- 360° swivel connection to avoid hose coiling
- Progressive lever mechanism with safety trigger
- Includes one 3 mm collet

			BAR										
BP822E	7314150184279	10	6.3 bar	1/4" in	10 mm	113 l/min	25000 min	76 dBA	4.53 m/s ²	200 W	258 mm	0.70 kg	



BP823

Disc grinders with rubber grip and safety trigger



- Disc grinder 5" for cutting and trimming
- For grinding and cutting off
- Light, durable and insulated composite housing
- Toolless disc change mechanism
- Progressive lever mechanism with safety trigger
- Comfortable rubber covered support handle included
- Adjustable protective steel shield

			BAR									
BP823	7314150135004	1	6.3 bar	1/4" in	10 mm	340 l/min	10,000 min	83 dBA	6.07 m/s ²	650 W	235 mm	1.70 kg

BP127

Surface cleaners with 19 needles



- Straight handle needle scaler
- 19 needles 3 x 180 mm
- Adjustable needle support
- Progressive lever mechanism
- Suitable for rust removal on cars, boats, etc.

			BAR								
BP127	7314150137565	1	6.3 bar	1/4" in	10 mm	3700 min	97 dBA	8.7 m/s ²	375 mm	2.93 kg	

BP12718

Needle set



- Needle set for BP127 and BP127P

			BAR				
BP12718	8414909179002	1	BP127, BP127P	3 mm	200 mm	100 g	

BP601

5 Mm palm orbital sanders with velcro pad



- 224 W motor, 11,000 rpm
- Lightweight and comfortable composite housing with rubber grip
- Can be used with central vacuum systems for easy dust removal
- Velcro® pad included

					BAR										
BP601	7314150134526	1	152 mm	x	6.3 bar	1/4" in	10 mm	255 l/min	yes	11,000 min	80 dBA	<2.5 m/s ²	224 W	195 mm	0.8 kg

BP610

2.5 Mm palm orbital sanders with velcro pad



- 224 W motor, 11,000 rpm
- Lightweight and comfortable composite housing with rubber grip
- Can be used with central vacuum systems for easy dust removal
- Velcro® pad included

					BAR										
BP610	7314150134595	1	152 mm	x	6.3 bar	1/4" in	10 mm	255 l/min	yes	11,000 min	80 dBA	<2.5 m/s ²	224 W	215 mm	0.9 kg



BP825

1/2" reversible drills with rubber grip 13 mm

- Keyless chuck
- Light, durable composite housing with rubber covered handle
- Easy one-hand forward and reverse change
- 360° swivel connection to avoid hose coiling
- Progressive trigger mechanism
- Comfortable rubber covered support handle included

			BAR									
BP825	7314150134496	1	6.3 bar	1/4" in	10 mm	105 l/min	450 min	88 dBA	<2.50 m/s ²	220 W	210.5 mm	1.53 kg

4511-SET-25

Cobalt hss-e drill bit set for metal - 25 pcs



- Includes 25 drills from 1 mm to 13 mm x 0.5 mm in a plastic case
- Top angle of 135° with self-centring split-point tip for quick cutting and perfect centring
- Drill bits have a cylindrical shank (shank equal to drill bit diameter) and designed for use in drill stands and drill drivers
- The cobalt high-speed steel (HSS) provides long lasting high performance when drilling in stainless steel materials
- Cobalt drills work good in following materials alloyed/non-alloyed steel, stainless steel, cast iron, cast steel and acid- and heat-resistant steels
- Manufactured to DIN 338 N

				PCS/STK	
4511-SET-25	7314150373048	1		25	1200 g

1x 1.0; 1.5; 2.0; 2.5; 3.0; 3.5; 4.0; 4.5; 5.0; 5.5; 6.0; 6.5; 7.0; 7.5; 8.0; 8.5; 9.0; 9.5; 10.0; 10.5; 11.0; 11.5; 12; 12.5; 13.0mm

4513-SET-25

HSS-G drill bit set for metal - 25 pcs



- Includes 25 drills from 1 mm to 13 mm x 0.5 mm in a plastic case
- Top angle of 130° with self-centring split-point tip for quick cutting and perfect centring
- Drill bits have a cylindrical shank (shank equal to drill bit diameter) and designed for use in drill stands and drill drivers
- High-speed steel (HSS) drill for drilling in bronze, brass, carbon steel, cast iron, alloy steel and stainless steel
- Manufactured to DIN 338 N

				PCS/STK	
4513-SET-25	7314150372102	1		25	1200 g

1x 1.0; 1.5; 2.0; 2.5; 3.0; 3.5; 4.0; 4.5; 5.0; 5.5; 6.0; 6.5; 7.0; 7.5; 8.0; 8.5; 9.0; 9.5; 10.0; 10.5; 11.0; 11.5; 12; 12.5; 13.0 mm

4515-SET-25

HSS-R Drill Bit Set for Metal - 25 pcs



- Includes 25 drills from 1 mm to 13 mm in 0.5 mm steps in a plastic case
- Manufactured with rolled flutes for high elasticity and low risk of breakage
- Drill bits have a cylindrical shank (shank same as drill bit diameter) and are designed for use in drill stands and drill drivers
- Oxide coating reduces wear with good and rapid chip removal
- High speed steel (HSS) bits for drilling in bronze, brass, carbon steel, cast iron and alloy steel
- Manufactured to DIN 338
- Tip angle 118°

				PCS/STK	
4515-SET-25	7314150441709	1		25	1200 g

1x 1.0; 1.5; 2.0; 2.5; 3.0; 3.5; 4.0; 4.5; 5.0; 5.5; 6.0; 6.5; 7; 7.5; 8; 8.5; 9.0; 9.5; 10; 10.5; 11; 11.5; 12; 12.5; 13 mm



228-SET
HSS step drill set - 3 pcs

- Includes 3 pieces
- 4 mm to 12 mm in 1 mm increments
- 4 mm to 22 mm in 2 mm increments
- 5 mm to 35 mm in 13 mm increments
- Step drill set for making holes in thin sheet metals
- Titanium-nitride (TIN) coated step drill with a surface hardness that makes the tool last 4 to 5 times longer than ordinary step drill bits
- Same surface reduces friction, resulting in a tool that runs cooler and effective, self-lubricates while running dry
- Self-centering point
- Shank size 1/4" (6.35 mm) and 3/8" (10 mm) and 1/2" (12.7mm)
- For making holes in thin metal sheets
- Last up to five times longer than ordinary step drills
- Titanium-nitride (TIN) coating with a surface hardness
- Self-lubricates while running dry

228-SET-SD	7314150217946	1	560 g
228-SD			
229-SD			
230-SD			

BP828
Compact reciprocating saws with safety trigger



- An ideal tool for general auto body repair and modification, such as cutting exhaust pipes, corroded bolts and chassis beams
- 10,000 strokes per minute
- Lightweight and compact
- Low vibration
- Progressive safety throttle lever with lockout feature
- One blade included, 32 TPI
- Comfortable non-slip grip
- Compatible with: 3845-18-10P, 3845-24-10P, 3845-32-10P

			BAR									
BP828	7314150427260	1	6.3 bar	1/4" in	10 mm	62 l/min	10000 min	88-100.5 dBA	5.18 m/s ²	300 W	227 mm	0.6 kg

3845
Car body sandflex® bi-metal reciprocating sawblades



- For pneumatic and electrical machines, type Shinano, Chicago-Pneumatic or similar
- Designed to cut thin sheet metal, mostly used in car body workshops or in HVAC applications
- Sandflex® bi-metal blade material for effective performance and long-lasting blade life
- Packed in easy-to-use hard plastic cassette of 10 blades (-10P)

3845-32-10P	7311518101626	1	32	90 mm	0-2 mm	48 g



3940-METAL-SET-5P

Sandflex® Bi-Metal sabre sawblades set for metal - 5 pcs

- Set includes 3940-150-14-ST, 3940-150-18-ST, 3940-150-24-ST, 3940-228-18-ST, 3940-228-14-ST blades
- Metal blade set for cutting metal and fine metal
- Virtually unbreakable Sandflex® bi-metal blade for all materials and type of cut
- The standard shaped (ST) blades with high performance and precision-ground teeth
- HSS tothing with 8% Cobalt on a spring steel back on the Bi-Metal blades ensure extreme durability

			PCS/STK	
3940-METAL-SET-5P	7314150401673	5	5	125 g
3940-150-14-ST, 3940-150-18-ST, 3940-150-24-ST, 3940-228-18-ST, 3940-228-14-ST				

3940-HM

Sandflex® Bi-Metal sabre sawblade set for heavy metal

- The heavy metal blade family is designed for demanding metal cutting in thick materials
- Virtually unbreakable Sandflex® bi-metal blade for all materials and type of cut
- HSS tothing with 8% Cobalt on a spring steel back on the Bi-Metal blades ensure extreme durability
- Version 1: heavy standard (HST) bi-metal blades with precision ground teeth are a series of extra thick blades
- Wider body that makes it more rigid and has a higher resistance to fracturing and bending, allowing straighter cuts
- Version 2: standard (ST) bi-metal blades with coarse precision ground teeth are a series of flexible blades
- With standard body that makes it more flexible and easier to bend into position
- 0.9 mm to 1.3 mm thickness
- 8/12 TPI to 18 TPI
- 150 mm to 300 mm of length
- Packaging alternative 1: retail packed either in -2P = 2 blades or -5P = 5 blades per pack
- Packaging alternative 2: industrial pack, -10P = 10 blades per box

3940-150-10-ST-5P	7314150362172	5	150 mm	0.9 mm	10	ST	110 g

BP233

Windscreens removers with low vibration

- Exhaust hose for transporting air away and reduced noise
- Low vibration <math><2.5 \text{ m/s}^2</math>
- Progressive lever mechanism with safety trigger
- Includes straight offset blade BPBG5725
- Large assortment of blades and scrapers available separately

			BAR								
BP233	7314150134748	1	6.3 bar	1/4" in	10 mm	260 l/min	20	80.5 dBA	<math><2.2 \text{ m/s}^2</math>	200 mm	1.2 kg

BP910

Air hammers 3200 bpm

- Typical applications include removing ball joints, tie rods and bearings, shearing metal parts, breaking bolts and rivets, breaking concrete, etc.
- 3200 blows per minute for fast cutting action
- High performance and low weight (2.25 kg)
- Low noise (94 dBA) and low vibration (2.4 m/s²)
- High quality 10.2 mm round safety-lock retainer for quick chisel change
- Comfortable rubber grip

				BAR								
BP910	7314150427246	5	10.2 mm	6.3 bar	1/4" in	10 mm	55.5 l/min	67 mm	3200	94.3-106.6 dBA	2.4 m/s ²	239 mm 2.25 kg





BP125A

Air Riveters 1600 kg pulling force

- Typical applications include general purpose and automotive
- Ideal tool for riveting operations on panels and plates
- A reliable tool for general maintenance on light and heavy vehicles
- Durable and easy-to-use air riveter- Supplied with six nozzles for rivets sizes 2.4, 3.2, 4.0, 4.8, 5.6 and 6.4 mm
- For rivets in all materials up to 6.4 mm: aluminium, steel, stainless steel and structural, including blind rivets
- Supplied with steel rivets

				BAR					
BP125A	7314150427291	6	2.4-6.4	6.3 bar	1/4" in	1600 kg	19	260 mm	2 kg



BP799

Air engraving markers with low vibration

- Pneumatic engraving pen
- For fast and secure marking
- 60" flexible air hose with textile sheath
- Air exhaust at the front to clear the workspace

			BAR							
BP799	7314150134502	1	6.3 bar	1/4 in	10 mm	13,000 min	78 dBA	<2.0 m/s ²	140 mm	0.24 kg



BPHVLP01

HVLP spray painting guns

- Plastic cup capacity 0.55 litre
- 5 nozzles included: 1.0 / 1.2 / 1.4 / 1.7 and 2.0 mm
- Adjustable pressure, adjustable spray width and adjustable paint flow.

			BAR					
BPHVLP01	7314150138937	1	2-2.8 bar	1/4" in	10 mm	250 l/min	185 mm	0.7 kg



BPN010

Cleaning guns with steel nozzle

- Two operating modes: cleaning (soap and air) and drying (air only)
- Very fast twisting nozzle
- Easily accessible operating mode switch.
- Tank capacity 1.0 litre

			BAR				
BPN010	7314150219728	1	6.2 bar	1/4" in	67 l/min	6000-7500 min	0.9 kg



BP218

Air blow guns with brass inlet

- Meets OSHA requirements
- Brass inlet

			BAR					
BP218	7314150170272	1	6.3 bar	1/4" in	158 l/min	>80 dBA	245 mm	0.19 kg



BP219

Air blow guns with brass inlet and removable safety tip

- Brass inlet

			BAR					
BP219	7314150235889	1	6.3 bar	1/4" in	68 l/min	<80 dBA	240 mm	0.13 kg



BP219L

Air blow guns with brass inlet and removable safety tip long nozzle

- Nozzle length 330 mm

			BAR					
BP219L	7314150235896	1	6.3 bar	1/4" in	340 l/min	<80 dBA	470 mm	0.15 kg



BP219XL

Air blow guns with brass inlet 1 m extra long nozzle

- For rapid removal of dust or other material, with many applications in trucks, buses, heavy vehicles, etc.
- For long reach with accurate airflow positioning
- Long 1 m nozzle
- Rubber tip protector to avoid damage to vehicle body

			BAR					
BP219XL	7314150427192	10	6.3 bar	1/4" in	100 l/min	>80 dBA	1050 mm	0.250 kg



BP254

1/2" filter regulator units

- Bowl capacity: 200 cc
- Temperature range: -5°C to 60°C
- Filters the air to avoid damage caused by dust
- Regulates desired pressure between 1 and 8.5 bar

			BAR			
BP254	7314150137633	1	1-8.5 bar	1/2" in	max 3800 L/min l/min	0.8 kg



BP255

1/2" filter regulator and lubricator units

- Bowl capacity: 200 cc
- Temperature range: -5°C to 60°C
- Filters the air to avoid damage caused by dust
- Regulates desired pressure between 1 and 8.5 bar
- Automatically lubricates the air to ensure correct operation and longer lifetime of air tools

			BAR			
BP255	7314150137640	1	1-8.5 bar	1/2" in	max 3,800 l/min	0.8 kg

BPHRC815/1015

Air hose reels with 145° swivel steel bracket and optional speed control adaptor

- Application: shop air hose and compressed air provision
- 145° swivel steel bracket
- Durable polypropylene housing resistant to corrosion and harsh environment
- Latching system automatically locks hose at desired length for increased functionality and comfort
- On-Off spring for latching system
- 100% PU hose for easy cleaning and longer reel life
- Speed control adaptor BPHRSC can be attached as an option







			BAR				
BPHRC1015	7314150247400	1	15 bar	3/8-3/8 in	14+1 m	10 mm	5.9 kg



BPHRC1020/1316

Air hose reels with 145° swivel steel bracket

- Application: shop air hose and compressed air provision
- Durable polypropylene housing resistant to corrosion and harsh environment
- Latching system automatically locks hose at desired length for increased functionality and comfort
- On-Off spring for latching system
- 100% PU hose for easy cleaning and longer reel life





			BAR				
BPHRC1020	7314150247417	1	15 bar	3/8-3/8 in	20 m	10 mm	8.3 kg
BPHRC1316	7314150247455	1	15 bar	1/2-1/2 in	15+1 m	13 mm	8.5 kg



BPH1310

Spiral air hoses with threaded connector 13 mm

- Polyurethane hose with fixed threaded connector at both ends

						
BPH1310A	7314150330003	1	13 mm	10 m	1/2"-1/2" in	1.67 kg







IMPACT SOCKETS





BWSS12P3

17, 19 and 21 mm impact wheel socket set

- Impact wheel socket set for easy access
- Plastic protection on socket walls to ensure protection of the rims
- Plastic protection inside the socket to ensure protection of wheel nuts
- Length: 85 mm, for deep access
- Drive: 1/2"
- Black phosphate finish
- High performance alloy steel
- Hardness: 40-48 HRC
- Includes 3 different sockets: 17 mm [blue], 19 mm [yellow] and 21 mm [red]
- Also available individually

BWSS12P3	7314150170128	20	17, 19, 21 mm	1/2 in	145 mm	125 mm	45 mm	0.87 kg	

BWSS12P317, BWSS12P319, BWSS12P321



BWSS12P5

17, 19, 21, 22 and 24 mm impact wheel socket set

- Impact wheel socket sets for easy access
- Plastic protection on socket walls to ensure protection of the rims
- Plastic protection inside the socket to ensure protection of wheel nuts
- Length: 85 mm, for deep access
- Drive: 1/2"
- Black phosphate finish
- High performance alloy steel
- Hardness: 40-48 HRC
- 5 available hexagonal dimensions: 17, 19, 21, 22 and 24
- Also sold individually

BWSS12P5	7314150170135	1	1/2 in	17, 19, 21, 22, 24 mm	50 mm	240 mm	175 mm	1.47 kg	

BWSS12P319, BWSS12P317, BWSS12P524, BWSS12P522, BWSS12P321



BT15P5

1/2" impact socket and bit set



- Used to hub assembly or disassembly, especially on VAG vehicles
- Set contents
- Hexagonal socket bits: 14 and 17 mm
- XZN sockets: 24, 30 and 32 mm
- Drive: 1/2"
- Black phosphate finish
- High performance alloy steel
- Hardness: 45-48 HRC
- Supplied in a blow moulded case, in plastic inlay for better tool management
- Also available individually

BT15P5	7314150205837	1	255 mm	85 mm	60 mm	0.92 kg	

BT15P524-BT15P536

1/2" impact socket with bihex profile



- Used for hub assembly or disassembly, especially on VAG vehicles
- Available hexagonal socket bits: 14 and 17 mm
- Available XZN sockets: 24, 30, 32 and 36 mm
- Drive: 1/2"
- Black phosphate finish
- High performance alloy steel
- Hardness: 45-48 HRC
- Part of the BT15P5 set
- Sold individually

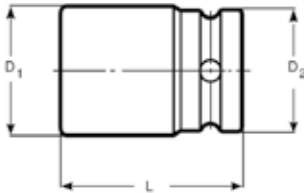

					D1	D2	L	
BT15P524	7314150231737	1	1/2 in	24 mm	33 mm	30 mm	38 mm	125 g
BT15P530	7314150231744	1	1/2 in	30 mm	41 mm	30 mm	45 mm	185 g
BT15P532	7314150231751	1	1/2 in	32 mm	43 mm	30 mm	45 mm	175 g
BT15P536	7314150342129	1	1/2 in	36 mm	50 mm	30 mm	50 mm	285 g

BHVIS08

3/4" heavy vehicle impact sockets Scania, Volvo



- Special heavy duty impact sockets
- Suitable for the majority of Scania (BHVIS0895, BHVIS08100) and Volvo (BHVIS08115) truck wheels
- Rear BHVIS08100
- Front BHVIS0895
- Drive: 3/4"
- Black phosphate finish
- High performance alloy steel

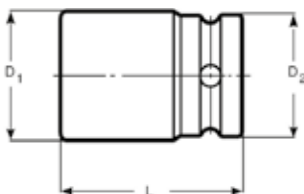

						D1	D2	L		
BHVIS0895	7314150165704	1	3/4 in	95 mm	118 mm	55 mm	81 mm	2.26 kg		
BHVIS08100	7314150165711	1	3/4 in	100 mm	123 mm	60 mm	84 mm	2.72 kg		
BHVIS08115	7314150165728	1	3/4 in	115 mm	138 mm	55 mm	81 mm	2.75 kg		
BHVIS109BPW12	7314150165759	1		41 mm	109 mm	129 mm	41 mm	94 mm	12 to	2.48 kg
BHVIS120BPW16	7314150165742	1		41 mm	120 mm	143 mm	41 mm	94 mm	12 to	2.99 kg

BHVIS12 / BHVIS06

1" thin wall impact sockets



- Extra thin wall heavy duty impact sockets
- Ideal for working on wheels and platforms
- Drive: 1"
- Black phosphate finish
- High performance alloy steel
- For maximum safety, always use clamping springs (1" 19-70 mm ref. K560F-7, 1" 75-80 mm ref. K560F-8, 1" 95-120 mm ref. K560F-9)

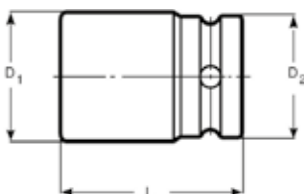

						L	D1	D2	
BHVIS1265	7314150167685	1	1 in	12	68 mm	92 mm	87 mm	54 mm	1.45 kg
BHVIS0670	7314150167692	1	1 in	6	70 mm	96 mm	96 mm	54 mm	2.01 kg
BHVIS0677	7314150167708	1	1 in	6	77 mm	102 mm	105 mm	60 mm	2.69 kg
BHVIS0680	7314150167715	1	1 in	6	80 mm	102 mm	108.5 mm	60 mm	2.8 kg
BHVIS0685	7314150167722	1	1 in	6	85 mm	106 mm	115 mm	86 mm	3.89 kg
BHVIS0690	7314150167739	1	1 in	6	90 mm	108 mm	121 mm	86 mm	4.25 kg
BHVIS0695	7314150167746	1	1 in	6	95 mm	110 mm	127 mm	86 mm	4.31 kg
BHVIS06100	7314150167753	1	1 in	6	100 mm	120 mm	134 mm	95 mm	5.51 kg
BHVIS06105	7314150167760	1	1 in	6	105 mm	120 mm	140 mm	95 mm	6.27 kg

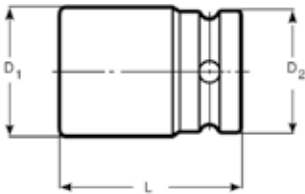

BHVISxxBPW

3/4" Square drive special impact socket for bpw axles

- Special impact sockets for BPW axles
- Specially shaped outlet
- Features different sizes per axle capacity
- Drive: 3/4"
- Black phosphate finish
- High performance alloy steel

						D1	D2	L	0+0	kg
BHVIS111BPW12	7314150165735	1	3/4 in	41 mm	111 mm	132 mm	47 mm	94 mm	12 to	3.00 kg
BHVIS80BPW12	7314150165766	1	3/4 in		80 mm	108 mm	45 mm	65 mm	12 to	1.27 kg
BHVIS95BPW9	7314150243334	1	3/4 in		95 mm	115 mm	45 mm	68 mm	9 to	2.1 kg

BWTB1290-BWTB12P200

Torsion bars with 1/2" drive designed for tightening wheel nuts with an impact wrench without exceeding the recommended torque

- Designed for tightening wheel nuts with an impact wrench without exceeding the recommended torque
- Colour coded ring for easy identification of the maximum torque of each bar:
- Green: 90Nm / Black: 100Nm / Gold: 110Nm / Red: 120Nm / Blue: 135Nm / Orange: 150Nm / Grey: 160Nm / Purple: 175Nm / White: 190Nm / Light green: 200Nm
- We recommend always using a torque wrench to adjust the final specified tightening torque
- Drive: 1/2" drive
- Black phosphate finish
- High performance alloy steel
- Hardness: 40-48 HRC
- Retail packed with an anti-theft plastic clip
- Part of the BWTB12P5 set



				Nm		kg
BWTB12P100	7314150329830	1	1/2 in	100 N-m	200 mm	0.195 kg
BWTB12P110	7314150329847	1	1/2 in	110 N-m	200 mm	0.205 kg
BWTB12P120	7314150329854	1	1/2 in	120 N-m	200 mm	0.225 kg
BWTB12P135	7314150329861	1	1/2 in	135 N-m	200 mm	0.245 kg
BWTB12P150	7314150329878	1	1/2 in	150 N-m	200 mm	0.265 kg
BWTB12P160	7314150329885	1	1/2 in	160 N-m	200 mm	0.29 kg
BWTB12P175	7314150329892	1	1/2 in	175 N-m	200 mm	0.305 kg
BWTB12P190	7314150329908	1	1/2 in	190 N-m	200 mm	0.335 kg
BWTB12P200	7314150329915	1	1/2 in	200 N-m	200 mm	0.350 kg
BWTB12P90	7314150329823	1	1/2 in	90 N-m	200 mm	0.200 kg



D/S14

1/2" Square drive impact socket set with metric hex profile and phosphate finish - 14 pcs

- K7081 1/2" impact sockets 10 mm, 11 mm, 12 mm, 13 mm, 14 mm, 15 mm, 16 mm, 17 mm, 18 mm, 19 mm, 21 mm, 22 mm, 24 mm, 27 mm
- To be used with machines
- For maximum safety use clamping springs
- Phosphate finish
- High-performance alloy steel
- Dynamic-Drive™ Profile to protect nuts, screws and tools from unnecessary wear and damage
- Drive standard: DIN 3121-G 12.5 ISO 1174
- Standards: DIN 3129, ISO 2725
- Removable 3-section plastic box

D/S14	7311518280314	6	14	2155 g

K7801M-10, K7801M-11, K7801M-12, K7801M-13, K7801M-14, K7801M-15, K7801M-16, K7801M-17, K7801M-18, K7801M-19, K7801M-21, K7801M-22, K7801M-24, K7801M-27



DD/S14

1/2" Square drive deep impact socket set with metric hex profile and phosphate finish - 14 pcs

- K7806M 1/2" deep impact sockets 10 mm, 11 mm, 12 mm, 13 mm, 14 mm, 15 mm, 16 mm, 17 mm, 18 mm, 19 mm, 21 mm, 22 mm, 24 mm, 27 mm
- To be used with machines
- For maximum safety use clamping springs
- Phosphate finish
- High-performance alloy steel
- Dynamic-Drive™ Profile to protect nuts, screws and tools from unnecessary wear and damage
- Drive standard: DIN 3121-G 12.5 ISO 1174
- Case with two-component handle, 3-piece removable plastic box

DD/S14	7311518280338	4	14	5085 g

K7806M-10, K7806M-11, K7806M-12, K7806M-13, K7806M-14, K7806M-15, K7806M-16, K7806M-17, K7806M-18, K7806M-19, K7806M-21, K7806M-22, K7806M-24, K7806M-27



K7806Z/10

1/2" Square drive deep impact socket set with imperial hex profile and phosphate finish - 10 Pcs

- K7806Z/10 1/2" impact sockets 7/16", 1/2", 9/16", 5/8", 11/16", 3/4", 13/16", 7/8", 15/16", 1"
- To be used with machines
- For maximum safety use clamping springs
- Phosphate finish
- High-performance alloy steel
- Dynamic-Drive™ Profile to protect nuts, screws and tools from unnecessary wear and damage
- Drive standard: DIN 3121-G 12.5 ISO 1174
- In plastic box 4750BMC5

K7806Z/10	7314150165025	1	280 mm	220 mm	60 mm	2870 g

K7806Z-7/16, K7806Z-1/2, K7806Z-9/16, K7806Z-3/4, K7806Z-13/16, K7806Z-11/16, K7806Z-1, K7806Z-7/8, K7806Z-15/16, K7806Z-5/8





K7800M/13

1/2" Square drive ultrashort impact socket set, 1/2" - 13 pcs

- Ultrashort impact socket set with 7800M series metric sockets
- Socket hex depth does not meet ISO 2725-2 standard
- More than 25% total length reduction
- Material: high performance alloy steel, ideal for impact use
- For use with machines. For maximum safety, use clamping springs
- Components: 10, 11, 12, 13, 14, 15, 16, 17, 18, 19, 21, 22, 24 mm

K7800M/13	7314150437221	1	195 mm	128 mm	43 mm	1040 g

K7800M-10, K7800M-11, K7800M-12, K7800M-13, K7800M-14, K7800M-15, K7800M-16, K7800M-17, K7800M-18, K7800M-19, K7800M-21, K7800M-22, K7800M-24

4750IB-A5

K7806M/S4

1/2" Square drive deep impact socket set in case with metric hex profile and phosphate finish - 4 pcs

- K7806M 1/2" deep impact sockets 17 mm, 19 mm, 22 mm, 24 mm
- To be used with machines
- For maximum safety use clamping springs
- Phosphate finish
- High-performance alloy steel
- Dynamic-Drive™ Profile to protect nuts, screws and tools from unnecessary wear and damage
- Reinforced design, especially suited for wheel nuts
- In cardboard packaging
- Drive standard: DIN 3121-G 12.5 ISO 1174

K7806M/S4	7314151813222	1	195 mm	130 mm	43 mm	1140 g

K7806M-19, K7806M-22, K7806M-17, K7806M-24

4750IB-A5

K8906M/8

3/4" Square drive deep impact socket set with metric hex profile and phosphate finish - 8 pcs

- K8906M 3/4" deep impact sockets 21 mm, 22 mm, 24 mm, 27 mm, 30 mm, 32 mm, 36 mm, 41 mm
- To be used with machines
- For maximum safety use clamping springs
- Phosphate finish
- High-performance alloy steel
- Dynamic-Drive™ Profile to protect nuts, screws and tools from unnecessary wear and damage
- In plastic box 4750BMC7
- Drive standard: DIN 3121-H 20, ISO 1174

K8906M/8	7314150165056	1	315 mm	250 mm	80 mm	4130 g

K8906M-24, K8906M-27, K8906M-30, K8906M-41, K8906M-36, K8906M-21, K8906M-22, K8906M-32





K8906Z/8

3/4" Square drive deep impact socket set with imperial hex profile and phosphate finish - 8 pcs



- K8906Z 3/4" deep impact sockets 1", 1-1/16", 1-1/8", 1-1/4", 1-5/16", 1-3/8", 1-7/16", 1-1/2"
- To be used with machines
- For maximum safety use clamping springs
- Phosphate finish
- High-performance alloy steel
- Dynamic-Drive™ Profile to protect nuts, screws and tools from unnecessary wear and damage
- In plastic box 4750BMC7
- Drive standard: DIN 3121-H 20, ISO 1174

K8906Z/8	7314150165063	1	110 mm	250 mm	125 mm		7360 g

K8906Z-1, K8906Z-1.1/16, K8906Z-1.1/8, K8906Z-1.1/4, K8906Z-1.5/16, K8906Z-1.3/8, K8906Z-1.7/16, K8906Z-1.1/2



K8901Z/18

3/4" Square drive impact socket set with imperial hex profile and phosphate finish - 18 pcs



- Contents: 3/4" impact sockets, in inches, 18 pcs K8901Z series
- DIN 3129, ISO 2725
- 3/4" DIN 3121-H 20, ISO 1174
- Finish: black finish
- Material: high performance alloy steel
- For use with machines
- For maximum safety, use clamping springs
- In metal box
- Components: 11/16", 3/4", 13/16", 7/8", 15/16", 1", 1-1/16", 1-1/8", 1-3/16", 1-1/4", 1-5/16", 1-3/8", 1-7/16", 1-1/2", 1-9/16", 1-5/8", 1-11/16", 1-3/4"

K8901Z/18	7314150436514	1	18	595 mm	210 mm	100 mm	12390 g

K8901Z-11/16, K8901Z-3/4, K8901Z-13/16, K8901Z-7/8, K8901Z-15/16, K8901Z-1, K8901Z-1.1/16, K8901Z-1.1/8, K8901Z-1.3/16, K8901Z-1.1/4, K8901Z-1.5/16, K8901Z-1.3/8, K8901Z-1.7/16, K8901Z-1.1/2, K8901Z-1.9/16, K8901Z-1.5/8, K8901Z-1.11/16, K8901Z-1.3/4





K9506M

1" Square drive deep impact sockets with metric hex profile and phosphate finish

- To be used with machines
- For maximum safety use clamping springs
- Phosphate finish
- High-performance alloy steel
- Dynamic-Drive™ Profile to protect nuts, screws and tools from unnecessary wear and damage
- T = depth of female hexagon
- Drive standard: DIN 3121-H 25, ISO 1174
- Standards: DIN 3129, ISO 2725

					L	A	D1	D2	T		
K9506M-22		7314151844998	1	22 mm	110 mm	76 mm	40 mm	54 mm	25 mm	K560F-7	1400 g
K9506M-24		7314151802530	1	24 mm	100 mm	76 mm	42 mm	54 mm	25 mm	K560F-7	1400 g
K9506M-27		7314151802547	1	27 mm	100 mm	76 mm	46 mm	54 mm	28 mm	K560F-7	1000 g
K9506M-30		7314151802554	1	30 mm	100 mm	76 mm	49.5 mm	54 mm	30 mm	K560F-7	1320 g
K9506M-32		7314151802561	1	32 mm	100 mm	76 mm	52 mm	54 mm	30 mm	K560F-7	1280 g
K9506M-33		7314151802578	1	33 mm	100 mm	76 mm	53 mm	54 mm	30 mm	K560F-7	1250 g
K9506M-34		7314151845018	1	34 mm	100 mm	34 mm	53.5 mm	54 mm	35 mm	K560F-7	1150 g
K9506M-36		7314151802585	1	36 mm	100 mm	76 mm	57 mm	54 mm	35 mm	K560F-7	1180 g
K9506M-38		7314151802592	1	38 mm	100 mm	76 mm	59.5 mm	54 mm	38 mm	K560F-7	1260 g
K9506M-41		7314151802608	1	41 mm	100 mm	76 mm	63 mm	54 mm	38 mm	K560F-7	1360 g
K9506M-46		7314151802615	1	46 mm	100 mm	76 mm	69.5 mm	54 mm	38 mm	K560F-7	1590 g
K9506M-50		7314151802622	1	50 mm	100 mm	76 mm	74.5 mm	54 mm	38 mm	K560F-7	1770 g
K9506M-55		7314151802639	1	55 mm	100 mm	76 mm	81 mm	54 mm	38 mm	K560F-7	1960 g
K9506M-60		7314151802646	1	60 mm	120 mm	76 mm	87.5 mm	54 mm	43 mm	K560F-7	2720 g



SOCKET SETS





S0810L

1/4" Square drive deep socket set with metric hex profile

- 1/4" deep hex sockets: 4, 5, 6, 7, 8, 9, 10, 11, 12 and 13 mm
- Matte finish
- High-performance alloy steel
- Case: ABS
- Standards: ISO 1174 and DIN 3120

S0810L	7314150256594	20	160 mm	85 mm	35 mm	415 g



A6709MZ/9

1/4" Square drive deep socket 9-piece set for metric and imperial hex head screw

- 9-piece set
- Includes sizes in metric: 2.5, 3, 4, 5, 6 mm
- Includes sizes in inches: 1/8, 9/64, 5/32, 3/16 inch
- Not suitable for machine operation
- Highly polished finish
- High-performance alloy steel
- Standards: ISO 1174 and DIN 3120
- Spare plastic box: SPAR-CASE-A6

A6709MZ/9	7314150512096	1	195 mm	130 mm	46 mm

A6709M-2.5, A6709M-3, A6709M-4, A6709M-5, A6709M-6		
A6709Z-1/8, A6709Z-9/64, A6709Z-5/32, A6709Z-3/16		
SPAR-CASE-A6		



6706TE

1/4" Square drive socket set with torx® head screw



- 1/4" square drive TORX® sockets E4, E5, E6, E7, E8 and E10
- Highly polished finish
- High-performance alloy steel
- Knurled shank for finger turning of free running fasteners
- Standards: ISO 1174 and DIN 3120

6706TE	7314150220199	1	6	150 g

6700TORX-E4, 6700TORX-E5, 6700TORX-E6, 6700TORX-E7, 6700TORX-E8, 6700TORX-E10		
--	--	--



SL24

1/4" Square drive socket set with metric hex profile and screwdriver bits



- 1-piece 1/4" extra narrow head ratchet, quick-release, 72 teeth/5°action angle
- 6-piece 1/4" hex sockets, 4, 5, 6, 7, 8 and 10 mm
- 2-piece 1/4" slotted bits, 4 mm, 5 mm
- 3-piece 1/4" Phillips bits, PH1, PH2 and PH3
- 2-piece hex bits, 4 mm and 5 mm
- 1-piece 1/4" x 1/4" locking bit socket
- 4-piece TORX® bits, T10, T15, T20 and T25
- 3-piece 1/4" Pozidriv bits, PZ1, PZ2 and PZ3
- 1-piece 1/4" smooth operation universal joint
- 1-piece 1/4" locking extension bar 100 mm/4"
- Matte finish
- High-performance alloy steel
- Case: high density polythene (HDPE), 35 mm x 165 mm x 85 mm
- Standards: ISO 1174 and DIN 3120

SL24	7314150128389	30	160 mm	85 mm	35 mm	430 g

SL25

1/4" Square drive socket set with metric hex profile and screwdriver bits/bit holder



- 12-Piece 1/4" hex sockets 4, 4.5, 5, 5.5, 6, 7, 8, 9, 10, 11, 12 and 13 mm
- One 1/4" compact length ratchet, quick release, 60 teeth/6° action angle, 125 mm
- Two 1/4" bits, PH2
- Two hex bits: 5 and 6 mm
- Six TORX® bit: T10, 15, 20, 25, 30 and 40
- One 1/4" bit holder with locking spring
- One 1/4" wobbler extension bar, 100 mm
- Matte finish
- High-performance alloy steel
- SB: Retail pack
- Less wear and damage to fastener thanks to Dynamic-Drive™ profile sockets
- Quick socket release button on ratchet
- Case: High density polythene (HDPE), 35 mm x 165 mm x 85 mm, SPAR-CASE-A6
- Standards: ISO 1174 and DIN 3120

SL25	7314153013422	20	160 mm	85 mm	35 mm	235 g

SL25L

1/4" Square drive socket and deep socket set with metric hex profile and screwdriver bits



- 12-piece 1/4" hex sockets: 4, 4.5, 5, 5.5, 6, 7, 8, 9, 10, 11, 12 and 13 mm
- 10-piece 1/4" hex deep sockets 4, 5, 6, 7, 8, 9, 10, 11, 12 and 13 mm
- 1-piece 1/4" compact length ratchet, quick-release, 60 teeth/6° action angle, 125 mm
- 2-piece 1/4" bits, PH2
- 1-piece 1/4" bit PZ2
- 3-piece bit hex, 4, 5 and 6 mm
- 6-piece TORX® bit, T10, 15, 20, 25, 30 and 40
- 1-piece 1/4" bit holder with locking spring
- 1-piece 1/4" wobbler extension bar 100 mm
- Matte finish
- High-performance alloy steel
- Case: ABS, 195 mm x 45 mm x 130 mm
- Standards: ISO 1174 and DIN 3120

SL25L	7314150256570	10	195 mm	130 mm	46 mm	970 g



S39MH

1/4" Square drive socket set with metric bi-hex profile and screwdriver bits/bit holder - 39 pcs

- 6-Piece 1/4" Bi-hex sockets 6, 7, 8, 10, 11 and 13 mm A6700DM
- One 1/4" compact length metal handle ratchet, quick release, 60 teeth/6° action angle, 125 mm
- One 1/4" adaptor 60 mm KM653-QR
- One 1/4" bit holder with locking spring 6973A
- One 1/4" bit square adaptor to 1/4" hexagon K6625-1/4
- Three 1/4" bits, PH1, PH2, PH3
- Three 1/4" bits, PZ1, PZ2, PZ3
- Four 1/4" Hexagonal bits, H3, H4, H5, H6
- Four 1/4" Flat bits, 4, 4.5, 6.5, 8
- Eight 1/4" Torx bits, T8, T10, T15, T20, T25, T27, T30, T40
- Seven 1/4" Torx Tamper bits, TR10, TR15, TR20, TR25, TR27, TR30, TR40
- Micro matte finish
- High-performance alloy steel
- Less wear and damage to fastener thanks to Dynamic-Drive™ profile sockets
- Quick socket release button on ratchet
- Case: High density polythene (HDPE), 35 mm x 165 mm x 85 mm, SPAR-CASE-A6
- Standards: ISO 1174 and DIN 3120

S39MH	7314150557301	20	160 mm	85 mm	35 mm	1/4" bi-hex 6,7,8,10,11,13;1/4" ratchet;1/4" adaptor;1/4" bit holder;1/4" PH1,PH2,PH3; 1/4" PZ1, PZ2, PZ3;1/4" H3,H4,H5,H6;1/4" 4, 4.5,6.5,8;1/4" T8,T10,T15,-T20,T25,T27,T30,T40;1/4" TR10,TR15,TR20,TR25,TR27,TR30,TR40					570 g

1/4" bi-hex 6,7,8,10,11,13;1/4" ratchet;1/4" adaptor;1/4" bit holder;1/4" PH1,PH2,PH3; 1/4" PZ1, PZ2, PZ3;1/4" H3,H4,H5,H6;1/4" 4, 4.5,6.5,8;1/4" T8,T10,T15,-T20,T25,T27,T30,T40;1/4" TR10,TR15,TR20,TR25,TR27,TR30,TR40

S160

1/4" Square drive socket set with metric hex profile and ratchet



- 12-Piece 1/4" hex sockets 4, 4.5, 5, 5.5, 6, 7, 8, 9, 10, 11, 12 and 13 mm
- One 1/4" ratchet, quick release, 60 teeth/6° action angle
- One 1/4" sliding T-bar, 100 mm/4"
- One 1/4" extension bar, 75 mm/3"
- One 1/4" flexible extension bar, 150 mm/6"
- Two removable three-section plastic box with lid
- Matte finish
- High-performance alloy steel
- Less wear and damage to fastener thanks to Dynamic-Drive™ profile sockets
- Quick socket release button on ratchet
- Case: High density polythene (HDPE)
- Standards: ISO 1174 and DIN 3120

S160	7314150104031	6	280 mm	160 mm	70 mm	1060 g

S160AF

1/4" Square drive socket set with imperial hex profile and ratchet



- 12-Piece 1/4" hex sockets 1/8, 5/32, 3/16, 7/32, 1/4, 9/32, 5/16, 11/32, 3/8, 7/16, 1/2 and 9/16"
- One 1/4" ratchet, quick release, 60 teeth/6° action angle
- One 1/4" sliding T-bar, 100 mm/4"
- One 1/4" extension bar, 75 mm/3"
- One 1/4" flexible extension bar, 150 mm/6"
- Two removable three-section plastic box with lid
- Matte finish
- High-performance alloy steel
- Case: High density polythene (HDPE)
- Standards: ISO 1174 and DIN 3120

S160AF	7314150137510	6	280 mm	160 mm	70 mm	1025 g

**S290****1/4" Square drive socket set with metric hex profile and ratchet/socket drivers**

- 12-Piece 1/4" hex sockets 4, 4.5, 5, 5.5, 6, 7, 8, 9, 10, 11, 12 and 13 mm
- One 1/4" ratchet, quick release, 60 teeth/6° action angle
- Three 1/4" Phillips socket drivers: PH1, PH2 and PH3
- Three 1/4" slotted socket drivers: 4, 5.5 and 7 mm
- Five 1/4" hex socket drivers, 3, 4, 5, 6 and 8 mm
- One 1/4" extension bar, 50 mm/2"
- One 1/4" extension bar, 150 mm/6"
- One 1/4" sliding T-bar, 100 mm/4"
- One 1/4" universal joint
- One 1/4" spinner with two-component handle
- Two removable three-section plastic box with lid
- Matte finish
- High-performance alloy steel
- Less wear and damage to fastener thanks to Dynamic-Drive™ profile sockets
- Quick socket release button on ratchet
- Case: High density polythene (HDPE)
- Standards: ISO 1174 and DIN 3120

S290	7314153000859	6	280 mm	160 mm	70 mm	1300 g

**S460****1/4" Square drive socket set with metric hex profile and socket drivers**

- 12-Piece 1/4" hex sockets 4, 4.5, 5, 5.5, 6, 7, 8, 9, 10, 11, 12 and 13 mm
- One 1/4" ratchet, quick release, 60 teeth/6° action angle
- Four 1/4" Phillips socket drivers, PH1, PH2, PH3 and PH4
- Three 1/4" slotted socket drivers: 4, 5.5 and 7 mm
- Six 1/4" hex socket drivers, 3, 4, 5, 6, 8 and 10 mm
- Seven 1/4" socket drivers, T8, T10, T15, T20, T25, T27 and T30
- Three 1/4" TORX® sockets: E6, 7 and 8
- One 1/4" spinner disc
- Two 1/4" extension bars, 2" and 4"
- One 1/4" sliding T-bar
- One 1/4" universal joint
- One 1/4" spinner with two-component handle
- One 1/4" flexible extension bar, 150 mm/6"
- Three hexagon L-keys: 1.5, 2 and 2.5 mm
- Three removable three-section plastic boxes with lid
- Matte finish
- High-performance alloy steel
- Less wear and damage to fastener thanks to Dynamic-Drive™ profile sockets
- Quick socket release button on ratchet
- Case: High density polythene (HDPE)
- Standards: ISO 1174 and DIN 3120

S460	7314150111060	6	375 mm	215 mm	100 mm	2220 g



SL65

1/4" Square drive socket set with metric hex profile and slim head ratchet - 65 pcs

- Slim head ratchet with quick socket release button
- 11 pcs 1/4" hex sockets 4, 4.5, 5, 5.5, 6, 7, 8, 10, 11, 12, 13 mm
- 1/4" slim head ratchet
- 1/4" extension 75 mm
- 1/4" extension 150 mm
- 1/4" spinner handle
- 1/4" d x 1/4" h coupler
- 1/4" magnetic bit holder quick release
- 3/8" f x 1/4" m 3-way adapter
- 1/4" bit adapter
- 1/4" flat bits 4, 5.5, 6.5 mm
- 1/4" Pozidriv bits 1, 2, 3
- 1/4" Phillips bits 0, 1, 2, 3, 4
- 1/4" Torx bits T8, T10, T15, T20, T25, T27, T30, T40
- 1/4" Hex bits 3, 4, 5, 6, 8, 10 mm
- 1/4" Pozidriv long bits 1, 2 (2x)
- 1/4" Phillips long bits 1, 2 (2x)
- 1/4" Torx long bits T10, T15, T20, T25 (2x), T27 (2x), T30 (2x)
- 1/4" hex long bits 3, 4, 5, 6 mm
- Matte finish
- High-performance alloy steel
- Less wear and damage to fasteners thanks to Dynamic Drive™ profile sockets
- Quick socket release button on ratchet
- Case: high density polythene (HDPE)
- Standards: ISO 1174 and DIN 3120

SL65	7314150444137	6	280 mm	160 mm	70 mm	1980 g



S1214L

3/8" Square drive deep socket set

- 3/8" deep sockets: 6, 7, 8, 9, 10, 11, 12, 13, 14, 15, 16, 17, 18 and 19 mm
- Matte finish
- High-performance alloy steel
- Case: ABS
- Standards: ISO 1174 and DIN 3120

S1214L	7314150256600	10	280 mm	152 mm	49 mm	1370 g

A7402SM-6, A7402SM-7, A7402SM-8, A7402SM-9, A7402SM-10, A7402SM-11, A7402SM-12, A7402SM-13, A7402SM-14, A7402SM-15, A7402SM-16, A7402SM-17, A7402SM-18, A7402SM-19



7400TORX-ER/

3/8" Square drive socket set for torx® head screw



- 7400TORX-E 3/8" square drive TORX® sockets, E8, E10, E11, E12, E14, E16 and E18
- Highly polished finish
- High-performance alloy steel
- Knurled shank for finger turning of free running fasteners
- Standards: ISO 1174 and DIN 3120

7400TORX-ER/S7	7314153003300	1	190 mm	55 mm	25 mm	333 g

7400TORX-E14, 7400TORX-E12, 7400TORX-E11, 7400TORX-E10, 7400TORX-E18, 7400TORX-E16, 7400TORX-E8





S330L

1/4" And 3/8" square drive deep socket set with metric hex profile and ratchet

- 12-piece 3/8" hex socket set: 10, 11, 12, 13, 14, 15, 16, 17, 18, 19, 20 and 22 mm
- 11-piece 3/8" hex deep sockets 10, 11, 12, 13, 14, 15, 17, 18, 19, 20 and 22 mm
- 1-piece 3/8" ratchet, quick-release, 60 teeth/6° action angle
- 2-piece 3/8" extension bars, 75 mm/3" and 150 mm/6"
- 1-piece 3/8" universal joint
- 1-piece 3/8" x 1/4" bit holder
- 2-piece 3/8" spark plug hex sockets, 16 mm (5/8") and 21 mm (13/16")
- 1-piece 1/4" spinner with two-component handle
- 1-piece 1/4" x 1/4" bit holder
- 3-piece 1/4" slotted bits, 4, 5.5 and 7 mm
- 3-piece 1/4" Phillips bits, PH1, PH2 and PH3
- 2-piece 1/4" bits, PZ1 and PZ2
- 7-piece 1/4" bits hex: 2.5, 3, 4, 5, 6, 7 and 8 mm
- 6-piece 1/4" TORX® bits, T10, T15, T20, T25, T30 and T40
- Matte finish
- High-performance alloy steel
- Case: high density polythene (HDPE)
- Standards: ISO 1174 and DIN 3120

S330L	7314150256587	4	375 mm	215 mm	100 mm	3730 g		
A7402SM-10, A7402SM-11, A7402SM-12, A7402SM-13, A7402SM-14, A7402SM-15, A7402SM-17, A7402SM-18, A7402SM-19, A7402SM-20, A7402SM-22								
7400SM-10, 7400SM-11, 7400SM-12, 7400SM-13, 7400SM-14, 7400SM-15, 7400SM-16, 7400SM-17, 7400SM-18, 7400SM-19, 7400SM-20, 7400SM-22								
7750QR								
7760-6								
7760-3								
7766								
7773A								
7402GPR-16, 7402GPR-21								
6956								
6973A								



S380

3/8" Square drive socket set with metric/imperial hex profile

- 12-piece 3/8" hex socket set: 1/4, 5/16, 11/32, 3/8, 7/16, 1/2, 9/16, 5/8, 11/16, 3/4, 13/16 and 7/8"
- 17-piece 3/8" hex sockets 6, 7, 8, 9, 10, 11, 12, 13, 14, 15, 16, 17, 18, 19, 20, 21 and 22 mm
- 2-piece 3/8" spark plug sockets, 16 and 21 mm
- 1-piece 3/8" ratchet, quick-release, 60 teeth/6° action angle
- 3-piece 3/8" extension bars, 3", 5" and 10"
- 1-piece 3/8" universal joint
- 1-piece 3/8" sliding T bar: 8"
- 1-piece 3/8" breaker bar with two-component handle: 10"
- Matte finish
- High-performance alloy steel
- Case: high density polythene (HDPE)
- Standards: ISO 1174 and DIN 3120

S380	7314150168934	4	375 mm	215 mm	100 mm	3750 g	



SL34

3/8" Socket set - 34 pcs

- Set includes 34 pieces
- 1 3/8" slim ratchet quick release, 60 teeth/6° action angle
- 2 3/8" extension bars 75 mm to 3" and 150 mm to 6"
- 1 3/8" universal joint
- 1 3/8" x 1/4" bit holder
- 12 3/8" bi-hex sockets (10 mm, 11 mm, 12 mm, 13 mm, 14 mm, 15 mm, 16 mm, 17 mm, 18 mm, 19 mm, 20 mm and 22 mm)
- 1 3/8" spark plug socket hex 16 mm (5/8")
- 1 3/8" spark plug socket hex 21 mm (13/16")
- 1 1/4" spinner with two-component handle
- 1 1/4" square female x 1/4" hexagonal male bit holder
- 3 1/4" bits: slotted 4, 5.5, 7 mm
- 4 1/4" bits: PH1, PH2, PH3, PH4
- 6 1/4" bits: hex 3 mm, 4 mm, 5 mm, 6 mm, 7 mm and 8 mm
- Matte finish
- High-performance alloy steel
- High density polythene (HDPE) case
- Standards: ISO 1174, DIN 3120

SL34	7314150409181	6	280 mm	160 mm	70 mm	1870 g



7810MH

1/2" Square drive socket set on rail with metric hex profile



- 7800SM 1/2" square drive socket hex profile metric, 10 pieces, 10, 11, 13, 14, 15, 16, 17, 19, 21 and 22 mm
- High-performance alloy steel
- Highly polished finish
- Less wear and damage to fastener thanks to Dynamic-Drive™ profile sockets
- Knurled shank for finger turning of free running fasteners
- Socket gives maximum load distribution and torque from the additional flank area
- Standards: ISO 1174 and DIN 3120

7810MH	7314150220373	1	10	810 g

7800SM-10, 7800SM-11, 7800SM-13, 7800SM-14, 7800SM-15, 7800SM-16, 7800SM-19, 7800SM-17, 7800SM-21, 7800SM-22



7810MB

1/2" Square drive socket set with metric bi-hex profile - 10 pcs/rail



- 7800DM 1/2" square drive socket bi-hex profile metric, 10, 11, 13, 14, 15, 16, 17, 19, 21 and 22 mm
- High-performance alloy steel
- Highly polished finish
- Less wear and damage to fastener thanks to Dynamic-Drive™ profile sockets
- Knurled shank for finger turning of free running fasteners
- Socket gives maximum load distribution and torque from the additional flank area
- Standards: ISO 1174 and DIN 3120

7810MB	7314150220380	1	10	740 g

7800DM-11, 7800DM-10, 7800DM-14, 7800DM-13, 7800DM-16, 7800DM-17, 7800DM-19, 7800DM-22, 7800DM-21, 7800DM-15

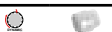



7806MD

1/2" Square drive socket set with metric bi-hex profile - 6 pcs/rail



- 7805DM 1/2" square drive socket bi-hex profile metric, 10, 13, 14, 17, 19 and 22 mm
- Highly polished finish
- High-performance alloy steel
- Less wear and damage to fastener thanks to Dynamic-Drive™ profile sockets
- Knurled shank for finger turning of free running fasteners
- Socket gives maximum load distribution and torque from the additional flank area
- Standards: ISO 1174 and DIN 3120

			PCS/STK	
7806MD	7314150220335	1	6	950 g

7805DM-10, 7805DM-14, 7805DM-13, 7805DM-17, 7805DM-19, 7805DM-22



7807TE

1/2" Square drive socket set on rail with torx® profile



- 7800TORX-E 1/2" square drive TORX® sockets on rail, E10, E12, E14, E16, E18, E20 and E24
- Knurled shank for finger turning of free running fasteners
- Highly polished finish
- High-performance alloy steel
- Standards: ISO 1174 and DIN 3120

			PCS/STK	
7807TE	7314150313792	1	7	600 g

7800TORX-E10, 7800TORX-E12, 7800TORX-E14, 7800TORX-E16, 7800TORX-E18, 7800TORX-E20, 7800TORX-E24



S1612L

1/2" Square drive deep socket set with metric hex profile

- 1/2" deep sockets 6-point hex profile metric 10, 11, 12, 13, 14, 15, 16, 17, 18, 19, 20 and 21 mm
- Matte finish
- 77 mm long sockets
- High-performance alloy steel
- Case: ABS
- Standards: ISO 1174 and DIN 3120

S1612L	7314150256617	4	280 mm	152 mm	49 mm	1930 g

7805SM-10, 7805SM-11, 7805SM-12, 7805SM-13, 7805SM-14, 7805SM-15, 7805SM-16, 7805SM-17, 7805SM-18, 7805SM-19, 7805SM-20, 7805SM-21





7809M/10

1/2" Square drive socket driver set for metric hex head screw



- 7809M 1/2" square drive hex socket drivers metric, 5, 6, 7, 8, 9, 10, 12, 14, 17 and 19 mm
- Highly polished finish
- High-performance alloy steel
- Insert of elastic plastic material to secure the tools
- Plastic case 4750BMC3
- Standards: ISO 1174 and DIN 3120

7809M/10	7314151831448	1	255 mm	110 mm	45 mm	1310 g

7809M-5, 7809M-6, 7809M-7, 7809M-8, 7809M-9, 7809M-10, 7809M-12, 7809M-14, 7809M-17, 7809M-19



7809Z/10

1/2" Square drive socket driver set for imperial hex head screw



- 7809Z 1/2" square drive hex socket drivers imperial, 3/16, 1/4, 5/16, 3/8, 7/16, 1/2, 17/32, 9/16, 19/32 and 5/8"
- High-performance alloy steel
- Highly polished finish
- Metal case
- Plastic inlay
- Standards: ISO 1174 and DIN 3120

7809Z/10	7314153003560	1	255 mm	110 mm	45 mm	1300 g

7809Z-3/8, 7809Z-5/16, 7809Z-7/16, 7809Z-1/4, 7809Z-19/32, 7809Z-5/8, 7809Z-17/32, 7809Z-9/16, 7809Z-1/2, 7809Z-3/16



S9TORX

1/2" Socket set with torx® bits - 9 pcs

- High performance alloy steel
- Matte finish
- 9 pcs 1/2" sockets with Torx bits T20, T25, T27, T30, T40, T45, T50, T55, T60
- Standards ISO 1174 and DIN 3120
- Case: ABS, 195x46x130 mm part number SPAR-CASE-A5

S9TORX	7314150412440	10	195 mm	130 mm	46 mm	910 g

7809TORX-T20, 7809TORX-T25, 7809TORX-T27, 7809TORX-T30, 7809TORX-T40, 7809TORX-T45, 7809TORX-T50, 7809TORX-T55, 7809TORX-T60

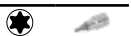



S18HEX

1/2" Socket set with hex bits - 18 pcs

- 18 pieces 1/2" socket set with hexagonal bits
- High performance alloy steel
- Matt finish
- 9 pcs 1/2" sockets with hexagonal short bits: 4, 5, 6, 7, 8, 10, 12, 14, 17 mm
- 9 pcs 1/2" sockets with hexagonal long bits: 4, 5, 6, 7, 8, 10, 12, 14, 17 mm
- Long sockets are 130 mm long
- Standards: ISO 1174, DIN 3120
- Case: ABS, 370x210x100 mm

S18HEX	7314150412457	4	370 mm	210 mm	100 mm		3520 g



S18TORX

1/2" Socket set with torx® bits - 18 pcs

- Set includes 18 pieces
- 9 1/2" sockets with short TORX® bits: T20, T25, T27, T30, T40, T45, T50, T55, T60
- 9 1/2" sockets with long TORX® bits: T20, T25, T27, T30, T40, T45, T50, T55, T60
- Matte finish
- High-performance alloy steel
- High density polythene (HDPE) case
- Standards: ISO 1174, DIN 3120

S18TORX	7314150412464	4	370 mm	210 mm	100 mm		2775 g



S240

1/2" Square drive socket set with metric hex profile and ratchet

- 18-Piece 1/2" hex sockets 10, 11, 12, 13, 14, 15, 16, 17, 18, 19, 20, 21, 22, 23, 24, 27, 30 and 32 mm
- One 1/2" ratchet, quick release, 60 teeth/6° action angle
- Two 1/2" extension bars, 5" and 10"
- One 1/2" universal joint
- One 1/2" T-adaptor
- One 1/2" breaker bar with two-components handle: 10"
- One removable three-section plastic box with lid
- Matte finish
- High-performance alloy steel
- Less wear and damage to fastener thanks to Dynamic-Drive™ profile sockets
- Quick socket release button on ratchet
- Case: High density polythene (HDPE)
- Standards: ISO 1174 and DIN 3120

S240	7314150104017	4	375 mm	215 mm	100 mm		4710 g

8150QR	
8166	
8160-5, 8160-10	
7772H	
8158-10	
7800SM-10, 7800SM-11, 7800SM-12, 7800SM-13, 7800SM-14, 7800SM-15, 7800SM-16, 7800SM-17, 7800SM-18, 7800SM-19, 7800SM-20, 7800SM-21, 7800SM-22, 7800SM-23, 7800SM-24, 7800SM-27, 7800SM-30, 7800SM-32	
S240-BOX	



S240AF

1/2" Square Drive Socket Set with Imperial Hex Profile and Ratchet



- 15-Piece 1/2" hex sockets 3/8, 7/16, 1/2, 9/16, 5/8, 11/16, 3/4, 13/16, 7/8, 15/16, 1, 1-1/16, 1-1/8, 1-3/16 and 1-1/4"
- One 1/2" ratchet, quick release, 60 teeth/6° action angle
- Two 1/2" extension bars, 5" and 10"
- One 1/2" universal joint
- One 1/2" T-adaptor
- One 1/2" breaker bar with two-components handle: 10"
- Two 1/2" spark plug hex sockets, 5/8" (16) and 13/16" (21)
- One removable three-section plastic box with lid
- Matte finish
- High-performance alloy steel
- Case: High density polythene (HDPE)
- Standards: ISO 1174 and DIN 3120

S240AF	7314150111077	4	375 mm	215 mm	100 mm	4880 g
8150QR						
8158-10						
7805GPR-16, 7805GPR-21						
8166						
7772H						
8160-5, 8160-10						
7800SZ-3/8, 7800SZ-7/16, 7800SZ-1/2, 7800SZ-9/16, 7800SZ-5/8, 7800SZ-11/16, 7800SZ-3/4, 7800SZ-13/16, 7800SZ-7/8, 7800SZ-15/16, 7800SZ-1, 7800SZ-1.1/16, 7800SZ-1.1/8, 7800SZ-1.3/16, 7800SZ-1.1/4						

S240-SPL

1/2" Square drive socket set with metric spline profile and ratchet- 24 pcs



- 18-Piece 1/2" spline profile sockets 10, 11, 12, 13, 14, 15, 16, 17, 18, 19, 20, 21, 22, 23, 24, 27, 30 and 32 mm
- One 1/2" ratchet, quick release, 60 teeth/6° action angle
- Two 1/2" extension bars, 5" - 125 mm and 10" - 250 mm
- One 1/2" universal joint
- One 1/2" T-adaptor for slidign T-handle
- One 1/2" breaker bar with two-components handle: 10"
- One removable three-section plastic box with lid
- Micro-Matte finish
- High-performance alloy steel
- Quick socket release button on ratchet
- Case: High density polythene (HDPE): S240-BOX
- Standards: ISO 1174 and DIN 3120

S240-SPL	7314150549009	4	375 mm	215 mm	100 mm	4570 g
8150QR						
8158-10						
8166						
7772H						
8160-5, 8160-10						
7800SPL-10, 7800SPL-11, 7800SPL-12, 7800SPL-13, 7800SPL-14, 7800SPL-15, 7800SPL-16, 7800SPL-17, 7800SPL-18, 7800SPL-19, 7800SPL-20, 7800SPL-21, 7800SPL-22, 7800SPL-23, 7800SPL-24, 7800SPL-27, 7800SPL-30, 7800SPL-32						



S400

1/2" Square drive socket set with metric hex profile and combination spanner set

- 21-Piece 1/2" hex sockets 10, 11, 12, 13, 14, 15, 16, 17, 18, 19, 20, 21, 22, 23, 24, 25, 26, 27, 28, 30 and 32 mm
- One 1/2" ratchet, quick release, 60 teeth/6° action angle
- Two 1/2" extension bars, 5" and 10"
- One 1/2" universal joint
- One 1/2" T-adaptor
- One 1/2" breaker bar with two-components handle: 10"
- 13-Piece combination spanners 7, 8, 9, 10, 11, 12, 13, 14, 15, 16, 17, 18 and 19 mm, on a practical removable tool-rack
- One removable three-section plastic box with lid
- Matte finish
- High-performance alloy steel
- Less wear and damage to fastener thanks to Dynamic-Drive™ profile sockets
- Easier access provided by thin compact head on combi wrench
- U-shaped handle for comfortable grip of spanners
- Quick socket release button on ratchet
- Case: High density polythene (HDPE)
- Standards: ISO 1174 and DIN 3120

S400	7314150111053	2	375 mm	320 mm	110 mm	7050 g	
8150QR							
8158-10							
8166							
7772H							
8160-5, 8160-10							
7800SM-10, 7800SM-11, 7800SM-12, 7800SM-13, 7800SM-14, 7800SM-15, 7800SM-16, 7800SM-17, 7800SM-18, 7800SM-19, 7800SM-20, 7800SM-21, 7800SM-22, 7800SM-23, 7800SM-24, 7800SM-25, 7800SM-26, 7800SM-27, 7800SM-28, 7800SM-30, 7800SM-32							
111M-7, 111M-8, 111M-9, 111M-10, 111M-11, 111M-12, 111M-13, 111M-14, 111M-15, 111M-16, 111M-17, 111M-18, 111M-19							



S560

1/4" And 1/2" square drive socket set with metric bi-hex profile and slim head ratchet

- 12-Piece 1/4" bi-hex sockets 4, 4.5, 5, 5.5, 6, 7, 8, 9, 10, 11, 12 and 13 mm
- 10 1/4" bi-hex deep sockets 4, 5, 6, 7, 8, 9, 10, 11, 12 and 13 mm
- 13-Piece 1/2" bi-hex sockets 10, 11, 12, 13, 14, 15, 17, 19, 22, 24, 27, 30 and 32 mm
- Three 5/16" TORX® bits: T45, T50 and T55
- One 1/4" magnetic adaptor
- Two 1/4" extension bars, 50 mm/2" and 100 mm/4"
- One 1/4" sliding T-bar, 100 mm/4"
- One 1/4" universal joint
- One 1/4" spinner with two-component handle
- One 1/4" bit holder
- One 1/4" bit adaptor
- Two 1/2" extension bars, 125 mm/5" and 250 mm/10"
- One 1/2" universal joint
- One 1/2" spark plug hex socket, 21 mm (13/16")
- One 1/2" T-adaptor
- One 1/2" x 5/16" bit holder
- Three hexagon L-keys: 1.5, 2 and 2.5 mm
- One 1/4" ratchet, quick release, 72 teeth/5° action angle, slim head
- One 1/2" ratchet, quick release, 72 teeth/5° action angle, slim head
- Matte finish
- High-performance alloy steel
- Less wear and damage to fastener thanks to Dynamic-Drive™ profile sockets
- Quick socket release button on ratchet
- Case: High density polythene (HDPE)
- Standards: ISO 1174 and DIN 3120

S560	7314150122264	4	375 mm	215 mm	100 mm	4665 g



S560MH

1/4" And 1/2" square drive socket set with metric bi-hex profile and metal handle ratchet - 56 pcs



- 12-Piece 1/4" bi-hex sockets 4, 4.5, 5, 5.5, 6, 7, 8, 9, 10, 11, 12 and 13 mm
- 10 1/4" bi-hex deep sockets 4, 5, 6, 7, 8, 9, 10, 11, 12 and 13 mm
- 13-Piece 1/2" bi-hex sockets 10, 11, 12, 13, 14, 15, 17, 19, 22, 24, 27, 30 and 32 mm
- Three 5/16" TORX® bits: T45, T50 and T55
- One 1/4" magnetic adaptor
- Two 1/4" extension bars, 50 mm/2" and 100 mm/4"
- One 1/4" sliding T-bar, 125 mm/5"
- One 1/4" universal joint
- One 1/4" spinner with metal handle
- One 1/4" bit holder
- One 1/4" bit adaptor
- 1/2" extension bars, 125 mm/5"
- 1/2 offset handle 8178
- 1/2 offset handle 8178
- One 1/2" spark plug hex socket, 21 mm (13/16")
- One 1/2" T-adaptor for slidign T-handle
- One 1/2" x 5/16" bit holder
- Three hexagon L-keys: 1.5, 2 and 2.5 mm
- One 1/4" metal handle ratchet, quick release, 60 teeth/6° action angle
- One 1/2" metal handle ratchet, quick release, 60 teeth/6° action angle
- Micro Matte finish
- High-performance alloy steel
- Less wear and damage to fastener thanks to Dynamic-Drive™ profile sockets
- Quick socket release button on ratchet
- Case: High density polythene (HDPE)
- Standards: ISO 1174 and DIN 3120

S560MH	7314150547593	4	375 mm	215 mm	100 mm		5025 g

8150MH	
7800DM-10, 7800DM-11, 7800DM-12, 7800DM-13, 7800DM-14, 7800DM-15, 7800DM-17, 7800DM-19, 7800DM-22, 7800DM-24, 7800DM-27, 7800DM-30, 7800DM-32	
8160-5	
8166	
8174A	
7772H	
7805GPR-21	
8178	
6950MH	
6960-2, 6960-4	
6966	
6954-5	
6956MH	
6973A	
KM653-1P	
A6700DM-5, A6700DM-5.5, A6700DM-6, A6700DM-7, A6700DM-8, A6700DM-9, A6700DM-10, A6700DM-11, A6700DM-12, A6700DM-13	
A6800DM-4, A6800DM-5, A6800DM-6, A6800DM-7, A6800DM-8, A6800DM-9, A6800DM-10, A6800DM-11, A6800DM-12, A6800DM-13	
70S/T45, 70S/T50, 70S/T55	
1995M-1.5, 1995M-2, 1995M-2,5	



S910

1/4" And 1/2" square drive socket and deep socket set with metric hex profile and combination spanner set

- 12-Piece 1/4" hex sockets 4, 4.5, 5, 5.5, 6, 7, 8, 9, 10, 11, 12 and 13 mm
- 10 1/4" hex deep sockets 4, 5, 6, 7, 8, 9, 10, 11, 12 and 13 mm
- 13-Piece 1/2" hex sockets 10, 11, 12, 13, 14, 15, 17, 19, 22, 24, 27, 30 and 32 mm
- Two 1/4" extension bars, 50 mm/2" and 100 mm/4"
- One 1/4" sliding T-bar
- One 1/4" universal joint
- One 1/4" bit holder
- One 1/4" bit adaptor
- One 1/4" spinner with two-component handle
- One 1/4" magnetic adaptor
- Five 1/4" Phillips bits, PH0, PH1, PH2, PH3 and PH4
- Three 1/4" slotted bits: 4, 5.5 and 7 mm
- Three 1/4" Pozidriv bits: PZ1, PZ2 and PZ3
- Six 1/4" hex bits, 3, 4, 5, 6, 8 and 10 mm
- Eight 1/4" TORX® bits, T8, T10, T15, T20, T25, T27, T30 and T40
- Three 5/16" TORX® bits: T45, T50 and T55
- Two 1/2" extension bars, 5" and 10"
- One 1/2" universal joint
- One 1/2" spark plug hex socket, 21 mm (13/16")
- One 1/2" x 5/16" bit holder
- One 1/2" T-adaptor
- Three hexagon L-keys: 1.5, 2 and 2.5 mm
- One 1/4" ratchet, quick release, 60 teeth/6° action angle
- One 1/2" ratchet, quick release, 60 teeth/6° action angle
- Four flex head wrenches, 8-9, 10-11, 12-13 and 14-15 mm
- Six combination spanners: 8, 10, 12, 13, 14 and 17 mm on a practical removable tool-rack
- One removable three-section plastic box with lid
- Matte finish
- High-performance alloy steel
- Less wear and damage to fastener thanks to Dynamic-Drive™ profile sockets
- Quick socket release button on ratchet
- Case: High density polythene (HDPE)
- Standards: ISO 1174 and DIN 3120

S910	7314150104000	2	375 mm	320 mm	110 mm	6880 g	



SLX 17

3/4" Square drive socket set with metric hex profile and ratchet head - 17 pcs/case

- 12-piece 3/4" hex sockets: 22, 24, 27, 30, 32, 33, 34, 36, 38, 41, 46 and 50 mm
- 1-piece 3/4" ratchet head 24 teeth/15° action angle (Part number 8955N/A)
- 1-piece telescopic handle 500 > 815 mm (Part number 8953E-32)
- 1-piece 3/4" sliding T-bar head
- 1-piece 3/4" extension bar 200 mm
- 1-piece 3/4" extension bar 400 mm
- Matte finish
- High-performance alloy steel
- Less wear and damage to fastener thanks to Dynamic-Drive™ profile sockets
- Quick socket release button on ratchet
- Case: high density polythene (HDPE)
- Standards: ISO 1174 and DIN 3120

SLX 17	7314153015785	1	110 mm	430 mm	375 mm	12838 g



SLX17AF

3/4" Square drive socket set with imperial hex profile and ratchet head - 17 pcs

- Contents, 17 pieces
- 12 pieces 3/4" hex sockets: 7/8", 15/16", 1-1/16", 1-3/16", 1-1/4", 1-5/16", 1-3/8", 1-7/16", 1-1/2", 1-5/8", 1-13/16", 2"
- 1 piece 3/4" ratchet head 24 teeth/15° action angle (part number 8955N/A)
- 1 piece telescopic handle 500 > 815 mm (part number 8953E-32)
- 1 piece 3/4" sliding T-bar head
- 1 piece 3/4" extension bar 200 mm/8"
- 1 piece 3/4" extension bar 400 mm/16"
- Matte finish
- High-performance alloy steel
- Case: High Density Polythene (HDPE)
- Standards: DIN 3120, ISO 1174

SLX 17AF	7314150137558	1	430 mm	375 mm	70 mm	13000 g



SLX20

3/4" Square drive socket set with metric hex profile and ratchet head - 20 pcs/case

- 12-piece 3/4" hex sockets: 19, 22, 24, 27, 30, 32, 33, 34, 38, 41, 46 and 50 mm (8900SM)
- 1-piece 3/4" round ratchet head 72 teeth/5° action angle (8950RN/A)
- 1-piece universal handle 400 mm (8953-16)
- 1-piece 3/4" sliding T-bar head (8954A)
- 1-piece 3/4" extension bar 200 mm (8960-8)
- 1-piece 3/4" extension bar 400 mm (8960-16)
- 1-piece 3/4" universal joint (8966)
- 1-piece 3/4" Drive Flex Handle Head (8957A)
- Matte finish
- High-performance alloy steel
- Less wear and damage to fastener thanks to Dynamic-Drive™ profile sockets
- Case: high density polythene (HDPE)
- Standards: ISO 1174 and DIN 3120

SLX20	7314150548989	2	110 mm	430 mm	375 mm	13125 g

8900SM-19, 8900SM-22, 8900SM-24, 8900SM-27, 8900SM-30, 8900SM-32, 8900SM-33, 8900SM-34, 8900SM-36, 8900SM-38, 8900SM-41, 8900SM-46, 8900SM-50		
8960-8, 8960-16		
8954A		
8950RN/A		
8953-16		
8966		
8957A		



8845NM

3/4" Square drive socket set with metric hex profile and round ratchet head/sliding t-head

- 8900SM 3/4" square drive socket hex profile metric, 22, 24, 27, 30, 32, 36, 38, 41, 46 and 50 mm
- 8950RN/A 3/4" reversible ratchet head
- 8955N/B 3/4" universal handle
- 8954-15A 3/4" sliding T head
- 8960-8 and 8960-16 3/4" extension bars, 200 and 400 mm
- Highly polished finish
- High-performance alloy steel
- Knurled shank for finger turning of free running fasteners
- Metal case with metallic inlay to hold the tools
- Standards: ISO 1174 and DIN 3120

8845NM	7314151810955	1	591 mm	206 mm	94 mm	13200 g
8900SM-24, 8900SM-22, 8900SM-27, 8900SM-30, 8900SM-32, 8900SM-36, 8900SM-38, 8900SM-41, 8900SM-46, 8900SM-50						
8953						
8954A						
8962, 8961						
8950N/A, 8950RN/A						
8955N/B						
8960-16, 8960-8						



8821MB

3/4" Square drive socket set with metric bi-hex profile and round ratchet head

- 8900DM 3/4" square drive socket bi-hex profile metric, 22, 23, 24, 26, 27, 28, 29, 30, 32, 34, 35, 36, 38, 41, 42, 46 and 50 mm
- 8950RN/A 3/4" reversible ratchet head
- 8954-15 3/4" sliding T-handle
- 8971 3/4" to 1/2" adaptor
- 8966 3/4" universal joint
- 8960-8 and 8960-16 3/4" extension bars, 200 and 400 mm
- Highly polished finish
- High-performance alloy steel
- Knurled shank for finger turning of free running fasteners
- Metal case with metallic inlay to hold the tools
- Standards: ISO 1174 and DIN 3120

8821MB	7314150220571	1	600 mm	220 mm	95 mm	14730 g
8950N/A, 8950RN/A						
8954, 8954-15						
8965, 8971						
8966						
8961, 8962						
8900DM-26, 8900DM-23, 8900DM-22, 8900DM-24, 8900DM-27, 8900DM-29, 8900DM-28, 8900DM-32, 8900DM-30, 8900DM-34, 8900DM-38, 8900DM-35, 8900DM-36, 8900DM-46, 8900DM-41, 8900DM-42, 8900DM-50						
8960-8, 8960-16						



9540MBL

1" Square drive socket set with metric hex profile and round head ratchet/adaptor

- 9500SM 1" square drive socket hex profile metric, 46, 50, 54, 55, 58, 60, 63, 65, 67, 70, 71, 75, 77 and 80 mm
- 9550AB 1" reversible ratchet head
- 9555 1" sliding T-head
- 9560AB and 9563AB 1" extension bars, 200 and 400 mm
- 9565AB Decreasing adaptor for 1" square drive and 3/4" sockets
- Matte finish
- High-performance alloy steel
- Standards: ISO 1174 and DIN 3120

9540MBL	7314153014115	1	120 mm	605 mm	225 mm		37600 g	
9500SM-80, 9500SM-77, 9500SM-71, 9500SM-70, 9500SM-67, 9500SM-65, 9500SM-63, 9500SM-60, 9500SM-75, 9500SM-46, 9500SM-50, 9500SM-54, 9500SM-55, 9500SM-58								
9550AB								
9560AB, 9563AB								
9555								



9540DZL

1" Socket set bihexagonal in inches. Metal case



- Matt finish
- DIN 3120

9540DZL	7314150414055	1	630 mm	285 mm	140 mm		36500 g	
9500DZ-2.1/4, 9500DZ-2.3/4, 9500DZ-2.3/8, 9500DZ-2.1/2, 9500DZ-2.15/16, 9500DZ-2.1/8, 9500DZ-1.7/8, 9500DZ-2.3/16, 9500DZ-3, 9500DZ-1.13/16, 9500DZ-3.1/8, 9500DZ-2.5/8, 9500DZ-2, 9500DZ-2.9/16								
9550AB								
9555								
9563AB, 9560AB								
9565AB								

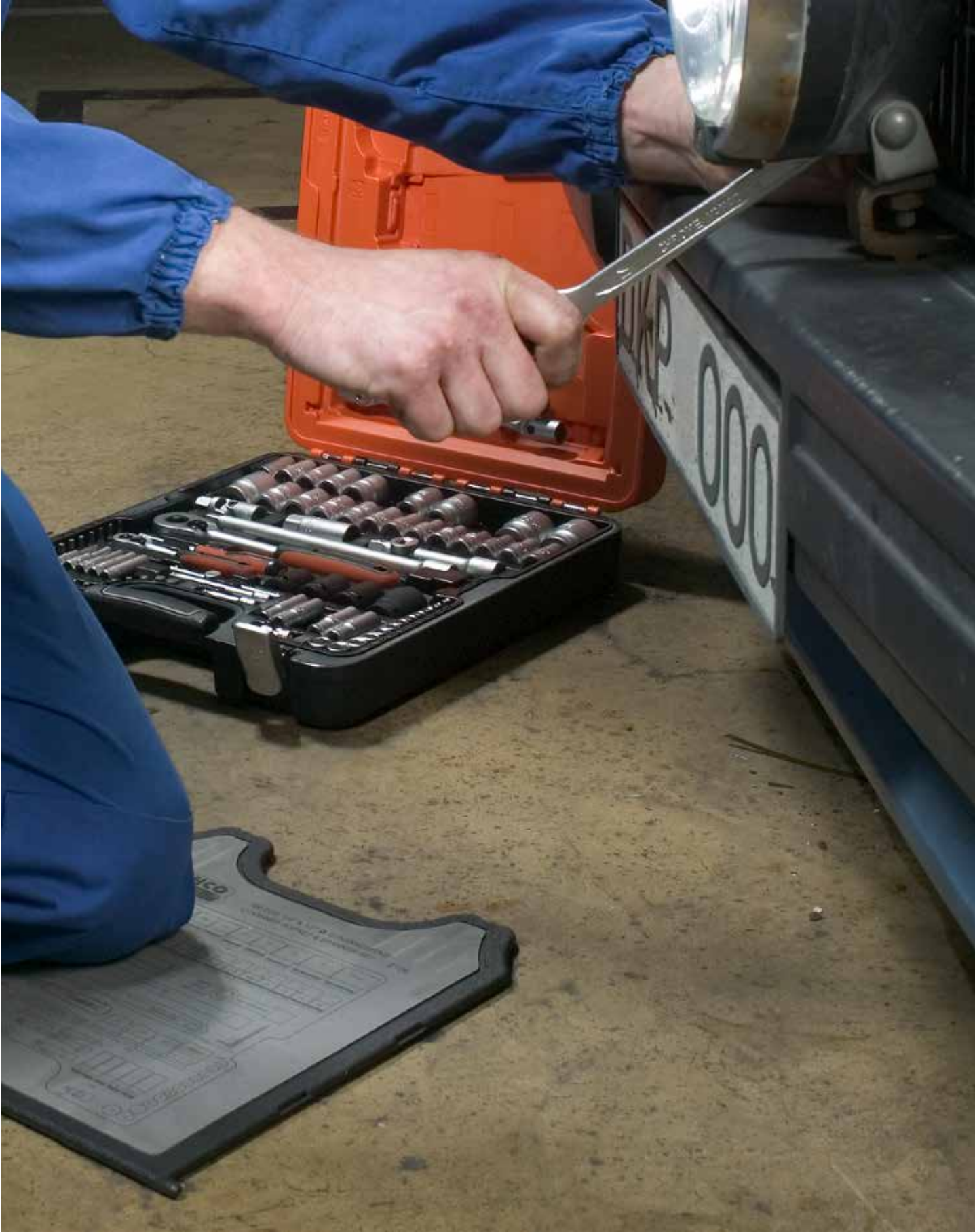



TORQUE TOOLS



BAHCO

TSS600

Adjustable torque screwdriver with marked scale in n·m

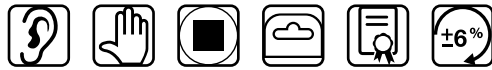

- Over-torque limiting clutch
- Dual scale in N·m and in.lb
- Torque measurement clockwise only
- Accurate to $\pm 6\%$ CW
- Clicking system triggers a tactile and audible signal
- $\frac{1}{4}$ " square drive
- Three-lobe rubber handle with additional female square to hold a $\frac{1}{4}$ " sliding T handle
- Supplied in an adjustable semi-transparent hanging tube
- Supplied with a factory declaration of conformity

						A	B	C	D	
TSS600	7314150346417	1	1-6 N·m	1/4 in	0.1 N·m	195 mm	18.2 mm	35 mm	9.6 mm	0.340 kg

74WR-15/74WR-25

Mechanical adjustable torque click wrench with window scale and fixed ratchet head

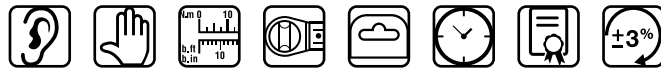

- Durable, reliable and accurate mechanism
- Fast scale adjustment reducing the effort required to adjust
- Large dual scale in N·m/in.lb
- Range covering from 3 to 25 N·m/27 - 220 in.lb torque values
- Can only be used clockwise
- Accurate to $\pm 3\%$ of reading which exceeds the requirements of ISO6789-1:2017
- Clicking system triggers a tactile and audible signal
- Reversible ratchet head with $\frac{1}{4}$ " square drives allowing CW operation only
- Handle centre or calibration force point marked on handle
- Lock/unlock knob with blue ring inside to warn the operator the wrench is unlocked
- In a semi-transparent square tube with eurohole hanger
- All wrenches come with a factory calibration certificate according to ISO 6789-2:2017
- Made in the UK

						A	B	C	D	E	F	
74WR-15	7314150415519	1	3-15 N·m 27-132 lbf·in	1/4 in	0.1 N·m	221 mm	209 mm	140 mm	25 mm	25 mm	18 mm	0.300 kg
74WR-25	7314150415526	1	5-25 N·m 44-220 lbf·in	1/4 in	0.2 N·m	221 mm	209 mm	140 mm	25 mm	25 mm	18 mm	0.300 kg

74WR-50/74WR-400

Mechanical adjustable torque click wrench with window scale and fixed push-through ratchet head



- Durable, reliable and accurate mechanism
- Fast scale adjustment reducing the effort required to adjust
- Large dual scale in N-m/ft.lb
- Range covering from 10 and 400 N-m/7.5 - 300 ft.lb torque values
- Can be used clockwise or anticlockwise by pushing across the square drive of the ratchet head
- Accurate to $\pm 3\%$ of reading which exceeds the requirements of ISO6789-1:2017
- Clicking system triggers a tactile and audible signal
- Push-through ratchet heads from 3/8" to 3/4" square drives allowing CW and ACW operations
- Handle centre or calibration force point marked on handle
- Lock/unlock knob with blue ring inside to warn the operator the wrench is unlocked
- In a semi-transparent square tube with eurohole hanger
- All wrenches come with a factory calibration certificate according to ISO 6789-2:2017
- Made in the UK

									A	B	C	D	E	F	kg
74WR-50	7314150415533	1	10-50 N-m	7.5-37.5 lbf-ft	3/8"	0.5 N-m	0.5 lbf-ft		335 mm	317 mm	231 mm	35 mm	37 mm	26 mm	0.7 kg
74WR-100	7314150415540	1	20-100 N-m	15-75 lbf-ft	1/2"	1 N-m	1 lbf-ft		387 mm	364 mm	278 mm	45 mm	48 mm	32 mm	0.9 kg
74WR-200	7314150415557	1	40-200 N-m	30-150 lbf-ft	1/2"	2 N-m	2 lbf-ft		470 mm	447 mm	361 mm	45 mm	48 mm	32 mm	1.1 kg
74WR-300	7314150415564	1	60-300 N-m	45-220 lbf-ft	1/2"	2 N-m	2 lbf-ft		593 mm	567 mm	480 mm	52 mm	48 mm	33 mm	1.4 kg
74WR-340	7314150415571	1	60-340 N-m	45-250 lbf-ft	1/2"	5 N-m	2 lbf-ft		685 mm	659 mm	572 mm	52 mm	48 mm	33 mm	1.5 kg
74WR-400	7314150415588	1	80-400 N-m	60-300 lbf-ft	3/4"	5 N-m	5 lbf-ft		686 mm	661 mm	574 mm	51 mm	47 mm	24 mm	1.9 kg

7455

Mechanical adjustable torque click wrench with marked scale and fixed ratchet head

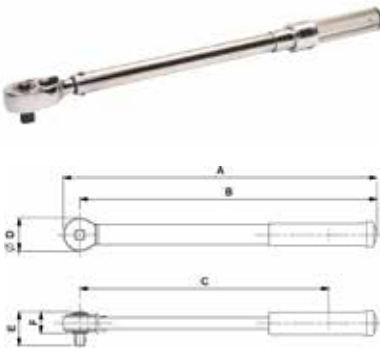

- Dual scales in N-m/ft.lb and N-m/in.lb (sizes 5-25 N-m)
- Range covering between 1 and 1,000 N-m /11 in.lb and 701 ft.lb torque values
- Can be used clockwise or anticlockwise
- Controlled torque application events to $\pm 4\%$ CW and ACW
- Clicking system triggers a tactile and audible signal
- Fixed ratchet heads with 24-36 teeth from 1/4 to 1" square drives (1/4" to 1/2" with quick release)
- All-metal rugged, durable wrench with sealed mechanism
- Anti-slip knurled metal handle resistant to impact, pressure and chemicals
- Sizes 5 to 340 N-m come in a semi-transparent tube with eurohole
- Sizes above in plastic blow mould case
- All wrenches come with a factory declaration of conformity according to ISO 6789-1:2017
- Made in USA

									A	B	C	D	E	F	kg
7455-15	7314150119646	1	3-15 N-m	31-128 lbf-in	1/4 in	0.1 N-m	0.89 lbf-in		258 mm	245 mm	200 mm	27 mm	24 mm	16 mm	0.409 kg
7455-20	7314150125074	1	4-20 N-m	40-173 lbf-in	1/4 in	0.1 N-m	0.89 lbf-in		258 mm	245 mm	200 mm	27 mm	24 mm	19 mm	0.386 kg
7455-25	7314150125081	1	5-25 N-m	49-217 lbf-in	1/4 in	0.1 N-m	0.89 lbf-in		286 mm	273 mm	226 mm	27 mm	24 mm	16 mm	0.410 kg
7455-60	7314150125098	1	12-60 N-m	9.2-42.4 lbf-ft	3/8 in	0.5 N-m	0.3 lbf-ft		393 mm	376 mm	326 mm	34 mm	30 mm	20 mm	1.135 kg
7455-100	7314150125111	1	20-100 N-m	16.6-71.9 lbf-ft	3/8 in	0.5 N-m	0.6 lbf-ft		400 mm	383 mm	333 mm	34 mm	30 mm	20 mm	1.135 kg
7455-200	7314150125128	1	40-200 N-m	37-140 lbf-ft	1/2 in	2 N-m	1.5 lbf-ft		474 mm	455 mm	405 mm	43 mm	41 mm	26 mm	1.430 kg
7455-300	7314150125104	1	60-300 N-m	52-314 lbf-ft	1/2 in	2 N-m	1.5 lbf-ft		483 mm	465 mm	415 mm	43 mm	41 mm	26 mm	1.440 kg
7455-340	7314150125135	1	68-340 N-m	52-243 lbf-ft	1/2 in	2 N-m	1.5 lbf-ft		613 mm	595 mm	545 mm	43 mm	41 mm	26 mm	1.680 kg
7455-500	7314150125142	1	100-500 N-m	83-359.6 lbf-ft	3/4 in	5 N-m	1.8 lbf-ft		870 mm	830 mm	780 mm	65 mm	53 mm	29 mm	4.370 kg
7455-800	7314150125159	1	160-800 N-m	129-572 lbf-ft	3/4 in	5 N-m	3.7 lbf-ft		1047 mm	1015 mm	970 mm	65 mm	53 mm	29 mm	5.310 kg
7455-1000	7314150368303	1	200-1000 N-m	184-701 lbf-ft	1 in	10 N-m	7.4 lbf-ft		1055 mm	1010 mm	970 mm	78 mm	68 mm	38 mm	6.350 kg

7455-1500

Mechanical adjustable torque click wrench with marked scale, fixed ratchet head and 2 section handle

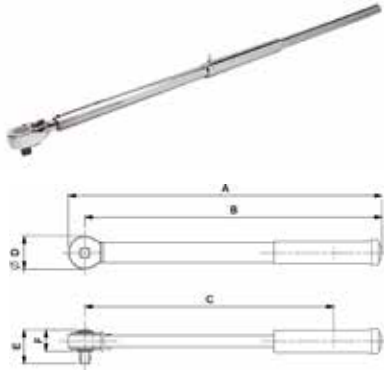

- Dual scale in N-m/ft.lb
- Can be used clockwise or anticlockwise
- Controlled torque application events to $\pm 4\%$ CW and ACW
- Clicking system triggers a tactile and audible signal
- Fixed ratchet head with 24 teeth in 1" square drive
- All-metal rugged, durable wrench with sealed mechanism
- Supplied in two pieces which need to be assembled for use and recalibration
- Supplied in a metal case with foam
- Supplied with a factory declaration of conformity according to ISO 6789-1:2017
- Made in USA

								A	B	C	D	E	F	
7455-1500	7314150125166	1	300-1500 N-m	258-1069 lbf-ft	1 in	10 N-m	7.4 lbf-ft	1780 mm	1740 mm	1690 mm	78 mm	68 mm	38 mm	11.395 kg

75R3/75R1

Mechanical adjustable free hand point torque click wrench with fixed ratchet head



- Non-length-dependant so can be used with or without the supplied extension handle (optional on 650 N-m)
- Large dual scale in N-m/ft.lb
- Range covering from 130 to 1,500 N-m/100 - 1100 ft.lb torque values
- Can be used clockwise or anticlockwise by pushing across the square drive of the ratchet head
- Accurate to $\pm 3\%$ of reading which exceeds the requirements of ISO6789-1:2017
- Exceptionally clear torque signal from the unique mechanism
- Push-through ratchet heads allowing CW and ACW operation
- Extension handle significantly reduces operator effort to achieve high torque values
- All in a portable sturdy blow mould case
- All wrenches come with a factory calibration certificate according to ISO 6789-2:2017
- Made in the UK

								A	B	C	D	E	F	L_{EXT}	
75R3-650	7314150415205	1	130-650 N-m	100-480 lbf-ft	3/4" in	5 N-m	5 lbf-ft	856 mm	823 mm	713 mm	66 mm	56 mm	30 mm	- mm	4.000 kg
75R3-800	7314150415212	1	200-800 N-m	150-600 lbf-ft	3/4" in	10 N-m	5 lbf-ft	1037 mm	999 mm	889 mm	75 mm	58 mm	33 mm	490 mm	5.200 kg
75R3-1000	7314150415229	1	300-1000 N-m	220-750 lbf-ft	3/4" in	10 N-m	5 lbf-ft	1245 mm	1208 mm	1097 mm	75 mm	58 mm	38 mm	490 mm	5.800 kg
75R1-1500	7314150415236	1	500-1500 N-m	370-1100 lbf-ft	1" in	10 N-m	10 lbf-ft	1571 mm	1533 mm	1422 mm	75 mm	66 mm	38 mm	490 mm	6.700 kg

7455-2500

Mechanical adjustable torque click wrench with marked scale and fixed square drive head

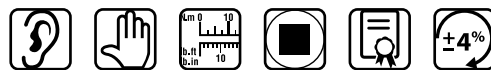
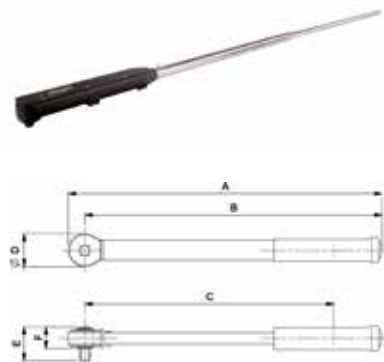

- Dual scale N-m/ft.lb
- Can be used clockwise
- Controlled torque application events to $\pm 4\%$ CW
- Clicking system triggers a tactile and audible signal
- Fixed square drive head without a ratcheting mechanism for high torque application
- All-metal rugged, durable wrench with sealed mechanism
- Supplied in three pieces which need to be assembled for use and calibration
- Supplied with a factory declaration of conformity according to ISO 6789-1:2017
- Made in USA

								A	B	C	D	E	F	
7455-2500	7314150125173	1	500-2500 N-m	406-1807 lbf-ft	1 in	10 N-m	7.4 lbf-ft	2720 mm	2675 mm	2625 mm	99 mm	108 mm	75 mm	24.120 kg



TAWMB MICRO

Digital torque and angle slim Bluetooth® wrench with memory and rectangular interchangeable head

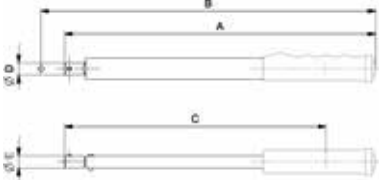

- Bluetooth® real-time 2-way data transfer
- Bahco Connect free app available for Windows 10, Android and iOS in 18 languages
- Easy to set up and use
- Recalibration warning by time and/or number of cycles
- Re-Do option
- Data download through the app
- Torque Units in Newton.metre, kg.cm, dNewton.metre, ft.lb, lb.in (cNewton.metre & in.oz depending on range), and angle units in degrees
- Can be used CW and CCW at temperatures between 5°C and 42°C
- Memory capacity for 1500 readings and up to 50 presets
- Torque, angle, torque and angle, torque then angle, preset and job modes
- Counter
- Data and set value retention during battery exchange
- Programmable automatic shut-off time
- More advanced configurations and settings available in user manual
- Accurate to ±2% CW - 3% CCW between 20% and 100% of max torque
- Accurate to ±4% CW and CCW between 5% and 19% of full scale
- Visual (dual LEDs + backlit LCD display), audible and vibration signal
- 9x12 interchangeable heads for multiple applications and versatility
- All metal body for high strength and long life
- Battery compartment with reverse threaded end cap for AA alkaline batteries (included)
- Supplied in sturdy blow-moulded case with a declaration of conformity according to ISO 6789-1:2017 traceable to International standards
- CE and UKCA marked
- Made in USA

												A	B	C	D	E	
TAWMB930M	7314150489640	1	1.5-30 N·m	13.2-265 lbf·in	1.1-22.1 lbf·ft	9x12 mm	0.01 N·m	0.01 lbf·ft	0.1 lbf·in	0-360°	259 mm	277 mm	211 mm	25 mm	19 mm	0.39 kg	
TAWMB9135M	7314150490110	1	6.8-135 N·m	60-1200 lbf·in	5-100 lbf·ft	9x12 mm	0.1 N·m	0.1 lbf·ft	1 lbf·in	0-360°	338 mm	355 mm	281 mm	25 mm	19 mm	0.73 kg	

Accuracy: 20% to 100% of full scale





TAWMB14_24

Digital torque and angle Bluetooth® wrench with memory and rectangular interchangeable head



- Bluetooth® real-time 2-way data transfer
- Bahco Connect free app available for Windows 10, Android and iOS in 18 languages
- Easy to set up and use
- Recalibration warning by time and/or number of cycles
- Re-Do option
- Data download through the app
- Torque units in Newton.metre, kg.cm, dNewton.metre, ft.lb, lb.in, and angle units in degrees
- Can be used CW and CCW at temperatures between 5°C and 42°C
- Memory capacity for 1500 readings and up to 50 presets
- Torque, angle, torque and angle, torque then angle, preset and job modes
- Counter
- Data and set value retention during battery exchange
- Programmable automatic shut-off time
- More advanced configurations and settings available in user manual
- Accurate to ±2% CW - 3% CCW between 20% and 100% of max torque
- Accurate to ±4% CW and CCW between 5% and 19% of full scale
- Visual (dual LEDs + backlit LCD display), audible and vibration signal
- 14x18 & 24x32 interchangeable heads for multiple applications and versatility
- All metal body for high strength and long life
- Battery compartment with reverse threaded end cap for AA alkaline batteries (included)
- Supplied in sturdy blow-moulded case with a declaration of conformity according to ISO 6789-1:2017 traceable to International standards
- CE and UKCA marked
- Made in USA

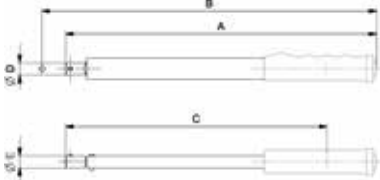

												A	B	C	D	E	
TAWMB14340	7314150489626	1	17-340 N·m	150.5-3009 lbf·in	12.5-250 lbf·ft	14x18 mm	1 N·m	1 lbf·ft	1 lbf·in	0-360°	610 mm	635 mm	530 mm	29 mm	25 mm	1.91 kg	
TAWMB24650	7314150490103	1	32.5-650 N·m	288-5753 lbf·in	24-479.4 lbf·ft	24x32 mm	1 N·m	1 lbf·ft	1 lbf·in	0-360°	857 mm	892 mm	812 mm	55 mm	40 mm	2.47 kg	
TAWMB24800	7314150489633	1	40-800 N·m	354-7080 lbf·in	29.5-590 lbf·ft	24x32 mm	1 N·m	1 lbf·ft	1 lbf·in	0-360°	1180 mm	1215 mm	1035 mm	55 mm	40 mm	4.0 kg	

Accuracy: 20% to 100% of full scale

TAWM

Electronic torque and angle wrench with memory/USB and fixed ratchet head. With memory and USB data download



- Torque units in N·m, kg.cm, dN·m, ft.lb, lb.in and angle units in degrees
- Torque range covers from 7 to 800 N·m and from 5.1 to 590 ft.lb
- It can be used CW and ACW at temperatures between 5 °C and 42 °C
- Memory capacity of 1,500 readings and up to 50 presets
- Plug and play USB data download to Excel format
- Torque, angle, torque and angle, torque then angle, preset and job modes
- Counter
- Data and set value retention during battery exchange
- Programmable automatic shut-off time
- Programmable Recalibration warning
- More advanced configurations and settings available in the user manual
- Accurate to ±2% CW and 3% ACW between 20% and 100% of max torque
- Visual (dual LEDs + backlit LCD display), audio and vibration signal
- 40-tooth fixed ratchet heads from 3/8" to 3/4" square drives
- All in a metal body and bezel for higher strength and duration
- Metal handle with reverse threaded end cap to enclose AA alkaline batteries (included)
- Supplied in sturdy blow mould case
- Supplied with a factory declaration of conformity and CE marking
- Made in USA



												A	B	C	D	E	F	
TAWM38135	7314150274918	1	7-135 N·m	62-1194 lbf·in	5.2-99.5 lbf·ft	3/8 in	1 N·m	1 lbf·in	1 lbf·ft	0-360°	475 mm	460 mm	380 mm	28 mm	28 mm	15 mm	1.280 kg	
TAWM12340	7314150274925	1	17-340 N·m	150.5-3009 lbf·in	12.5-250 lbf·ft	1/2 in	1 N·m	1 lbf·in	1 lbf·ft	0-360°	670 mm	650 mm	570 mm	35 mm	35 mm	18 mm	1.970 kg	
TAWM34800	7314150274932	1	40-800 N·m	354-7080 lbf·in	29.5-590 lbf·ft	3/4 in	1 N·m	1 lbf·in	1 lbf·ft	0-360°	1235 mm	1198 mm	1053 mm	60 mm	55 mm	40 mm	4.850 kg	

Accuracy: 20% to 100% of full scale





CAR BODY





BH8PR

Portable ram sets 4T and 10T

- Portable set of hydraulic equipment for straightening rams
- Quick click assembly system for easier and faster operation
- BH8PR10000 set: 10T capacity
- BH8PR4000 set: 4T capacity
- Each set contains: Hand pump, hose, hydraulic cylinder ram, spreader ram, rubber head, rubber faced flat base, 90° V-base, serrated saddle, male thread adaptor, and a wide selection of extension tubes
- Hose connector diameter: 1/4"
- Supplied in a sturdy blow moulded case
- The case of the 10T capacity set case is equipped with castors for easy handling

BH8PR10000	7314150178957	1	220 x 480 x 1030 mm	10 kN	1/4" in	31 kg
BH8PR4000	7314150178940	1	168 x 345 x 575 mm	4 kN	1/4" in	18.65 kg

BH8BC1

Body clamps

- Body clamps to attach different parts of the vehicle body to a slide hammer or a body straightener
- Can open and close them by operating the fixing system
- Different product shapes available
- Made of high performance Cr-Mo steel
- Black phosphate finish
- Packed in a cardboard box



BH8BC1	7314150242276	1	45 x 135 x 230 mm	2.11 kg

BH8BC2

Body clamps

- Body clamps to attach different parts of the vehicle body to a slide hammer or a body straightener
- Can open and close them by operating the fixing system
- Different product shapes available
- Made of high performance Cr-Mo steel
- Black phosphate finish
- Packed in a cardboard box



BH8BC2	7314150242283	1	51 x 150 x 220 mm	2.15 kg



BH8BC3

Body clamps

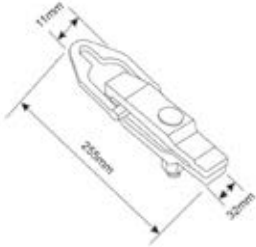

- Body clamps to attach different parts of the vehicle body to a slide hammer or a body straightener
- Can open and close them by operating the fixing system
- Different product shapes available
- Made of high performance Cr-Mo steel
- Black phosphate finish
- Packed in a cardboard box

BH8BC3	7314150242290	10	90 x 65 x 240 mm	1.65 kg

BH8BC4

Body clamps

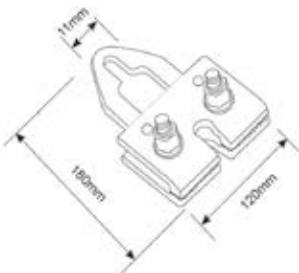

- Body clamps to attach different parts of the vehicle body to a slide hammer or a body straightener
- Can open and close them by operating the fixing system
- Different product shapes available
- Made of high performance Cr-Mo steel
- Black phosphate finish
- Packed in a cardboard box

BH8BC4	7314150242306	6	80 x 120 x 175 mm	2.44 kg

BH8BC5

Body clamps

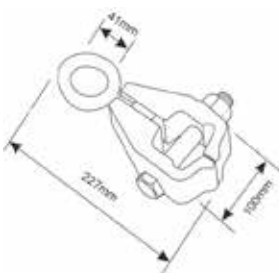

- Body clamps to attach different parts of the vehicle body to a slide hammer or a body straightener
- Can open and close them by operating the fixing system
- Different product shapes available
- Made of high performance Cr-Mo steel
- Black phosphate finish
- Packed in a cardboard box

BH8BC5	7314150242313	6	45 x 155 x 230 mm	3.02 kg



BBSH1F
Bodywork dressing hammer

- Surface shape: F (Flat) rectangle
- Finely polished surfaces
- Handle made of genuine hickory wood
- High performance alloy steel heads
- Hardness: 45-60 HRC

					W			
BBSH1F	7314150247189	1	50x30 mm	F /cm ²	60 mm	338 mm	45-60	390 g



BBSH1M
Bodywork dressing hammer

- Surface shape: M (Milled) rectangle
- Finely polished surfaces
- Handle made of genuine hickory wood
- High performance alloy steel heads
- Hardness: 45-60 HRC

					W			
BBSH1M	7314150247196	1	50x30 mm	M /cm ²	60 mm	338 mm	45-60	370 g



BBSH2C
Bodywork pein & finishing hammer

- Surface shape: C (Convex) round and small rectangular end
- Finely polished surfaces
- Handle made of genuine hickory wood
- High performance alloy steel heads
- Hardness: 45-60 HRC

						W			
BBSH2C	7314150247202	1	40 mm	20 mm	C /cm ²	140 mm	328 mm	45-60	460 g



BBSH2CA
Bodywork angled pein & finishing hammer

- Surface shape: C (Convex) round and small rectangular end at an angle
- Finely polished surfaces
- Handle made of genuine hickory wood
- High performance alloy steel heads
- Hardness: 45-60 HRC

						W			
BBSH2CA	7314150247219	12	40 mm	19 mm	C /cm ²	140 mm	328 mm	45-60 HRC	460 g



BBSH2CP
Bodywork pick & finishing hammer

- Surface shapes: C (Convex) round and small round
- Finely polished surfaces
- Handle made of genuine hickory wood
- High performance alloy steel heads
- Hardness: 45-60 HRC

						W			
BBSH2CP	7314150247226	6	40 mm	10 mm	C /cm ²	137 mm	328 mm	45-60	440 g

**BBSH2F****Bodywork pein & finishing hammer**

- Surface shape: F (Flat) round and small rectangular end
- Finely polished surfaces
- Handle made of genuine hickory wood
- High performance alloy steel heads
- Hardness: 45-60 HRC

						W			
BBSH2F	7314150247172	6	40 mm	19 mm	C /cm ²	141 mm	328 mm	45-60 HRC	460 g

**BBSH3CF****Bodywork bumping hammer**

- Surface shapes: F (Flat) square and C (Convex) round
- Finely polished surfaces
- Handle made of genuine hickory wood
- High performance alloy steel heads
- Hardness: 45-60 HRC

						W			
BBSH3CF	7314150247240	6	40 mm	37 mm	F - C /cm ²	100 mm	328 mm	45-60	500 g

**BBSH3CF30****Bodywork shop light bumping hammer**

- Surface shapes: F (Flat) square and C (Convex) round
- Finely polished surfaces
- Handle made of genuine hickory wood
- High performance alloy steel heads
- Hardness: 45-60 HRC

						W			
BBSH3CF30	7314150247264	6	30 mm	25 mm	F - C /cm ²	91 mm	328 mm	45-60	390 g

**BBSH3FS****Bodywork light shrinking hammer**

- Surface shapes: M (Milled) square and F (Flat) round
- Finely polished surfaces
- Handle made of genuine hickory wood
- High performance alloy steel heads
- Hardness: 45-60 HRC

						W			
BBSH3FS	7314150247257	6	40 mm	37 mm	SM - F /cm ²	102 mm	328 mm	45-60	520 g

**BBSH3MF****Bodywork shrinking hammer**

- Surface shapes: F (Flat) square and M (Milled) round
- Finely polished surfaces
- Handle made of genuine hickory wood
- High performance alloy steel heads
- Hardness: 45-60 HRC

						W			
BBSH3MF	7314150247233	1	30 mm	27 mm	F - M /cm ²	104 mm	328 mm	45-60	450 g



BBSDA

Bodywork american dolly

- Essential tool for hammering various surface shapes in the vehicle body
- Made of forged high performance alloy steel
- Sand blasted and polished finish

BBSDA	7314150247127	1	30 x 63 x 83 mm	1.07 kg



BBSDC

Bodywork comma dolly

- Essential tool for hammering various surface shapes in the vehicle body
- Made of forged high performance alloy steel
- Sand blasted and polished finish

BBSDC	7314150247158	6	40 x 58 x 128 mm	1.16 kg



BBSDD

Bodywork diablo dolly

- Essential tool for hammering various surface shapes in the vehicle body
- Made of forged high performance alloy steel
- Sand blasted and polished finish

BBSDD	7314150247165	1	55 x 55 x 55 mm	0.76 kg



BBSDH

Bodywork heel dolly

- Essential tool for hammering various surface shapes in the vehicle body
- Made of forged high performance alloy steel
- Sand blasted and polished finish

BBSDH	7314150247141	1	30 x 60 x 79 mm	0.87 kg



BBSDT

Bodywork toe dolly

- Essential tool for hammering various surface shapes in the vehicle body
- Made of forged high performance alloy steel
- Sand blasted and polished finish

BBSDT	7314150247134	6	26 x 58 x 120 mm	1.32 kg

**BBSDW****Bodywork wedge dolly**

- Essential tool for hammering various surface shapes in the vehicle body
- Made of forged high performance alloy steel
- Sand blasted and polished finish

BBSDW	7314150247110	6	25 x 64 x 112 mm	0.8 kg

**BBSDHR****Rubber heel dolly**

- Used in auto body work to smooth out dents and dings and form round panels
- Works great for door skins and flanges
- Designed for bumping and finishing
- Rubber coating absorbs shock to reduce metal stretching
- Made of alloy steel base with a rubber coating

BBSDHR	7314150249299	1	40 x 62 x 75 mm	0.36 kg

**BBSS1****Bodywork single spoon**

- Essential and professional tool for bodyshops
- Finely finished surfaces
- High performance alloy steel

BBSS1	7314150247288	1	25 x 56 x 390 mm	1.29 kg

**BBSS2****Bodywork double spoon short**

- Essential and professional tool for bodyshops
- Finely finished surfaces
- High performance alloy steel

BBSS2	7314150247271	8	150 x 60 x 410 mm	1.85 kg

**BBSS2L****Bodywork double spoon long**

- Essential and professional tool for bodyshops
- Finely finished surfaces
- High performance alloy steel

BBSS2L	7314150247295	1	175 x 60 x 520 mm	2.3 kg



BBS12SH
12 Kg slide hammer

- It allows pulling with greater force and less effort
- 12 kg mass with comfortable handle
- Features a double tip hook
- Overall length: 800 mm

BBS12SH	7314150243563	1	800 mm	12 kg	800 mm	135 mm	11.88 g



3-330
Pansar® milled tooth flat blades bastard/second cut unhandled



- For work in sheet metal, such as car bodies and refrigerators
- Suitable to use in soft materials where a high material removal rate and a smooth finish is required
- Provided with holes for holder screws
- 12" blade fits holders 9-463, 14" blade fits holder 9-462 and 9-463
- Surfaces flat and milled with curved teeth
- High removal rate in soft materials
- Shape: Flat edges and parallel surfaces
- Type of cut: 1 = Bastard, 2 = Second
- Convex surfaces milled with curved teeth
- Industry pack unhandled
- Packing: 5 pieces per box for 3-330-12-1-0
- Packing: Single sleeve pack

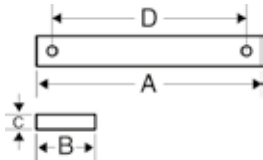

				A	B	C	D			
3-330-12-1-0		7311518020712	5	300 mm	30 mm	4.5 mm	275 mm	3	1	200 g
3-330-12-2-0		7311518020729	5	300 mm	30 mm	4.5 mm	275 mm	5	2	200 g
3-330-14-1-0		7311518020736	5	350 mm	35 mm	4.5 mm	325 mm	3	1	270 g
3-330-14-2-0		7311518020743	5	350 mm	35 mm	4.5 mm	325 mm	5	2	270 g



3-331
Pansar® milled tooth half-round blades bastard cut unhandled



- For work in sheet metal, such as car bodies and refrigerators
- For filing concave surfaces
- Also, in soft materials, where a high material removal rate and a smooth finish is required
- Provided with holes for holder screws
- 14" blade fits holder 9-462
- Surface convex and milled with curved teeth
- Shape: half-round, parallel edges
- The convex side is milled with curved teeth
- Type of cut: 1 = bastard
- Packing: Single sleeve pack

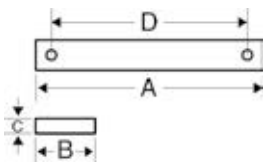

				A	B	C	D			
3-331-14-1-0		7311518020750	5	350 mm	30 mm	3.6 mm	325 mm	3	1	235 g



FM10

Ergo™ milled tooth filemasters with two-component handle



- File handle developed according to the scientific ERGO™ process
- Maximum comfort with minimum effort thanks to an ergonomic design
- Comfortable two-component handle giving an excellent grip
- One side shear cut, One side curved teeth
- Shear cut: for use on steel, plastics, laminates and hard woods
- Curved teeth: for fast removal of soft metals, lead, aluminium, soft wood and fillers
- Shape: edges parallel and uncut, surfaces have milled teeth
- High removal rate in soft materials leaving a smooth finish
- File is coated with a protective layer of paint
- Single pack carded complete with ERGO™ handle

				A	B	C		
FM12	7314150273249	5	300 mm	30 mm	5.5 mm	4 & 5	405 g	
FM10	7311518010881	5	250 mm	24.5 mm	5 mm	4 & 5	270 g	



HRFM10

Ergo™ milled tooth half-round filemasters with two-component handle



- File handle developed according to the scientific ERGO™ process
- Maximum comfort with minimum effort thanks to an ergonomic design
- Comfortable two-component handle giving an excellent grip
- High removal rate in soft materials leaving a smooth finish
- Curved teeth give fast removal of soft metals, lead, aluminium, soft wood and fillers
- For filing concaves, flat surfaces and large holes
- Shape: edges tapered towards the tip and are uncut
- Half-round surface has milled, curved teeth, concave back is uncut
- File is coated with a protective layer of paint
- Carded complete with ERGO™ handle

				A	B	C		
HRFM10	7311518010898	5	250 mm	22 mm	3.6 mm	5	182 g	

2220

Bodywork scraper set - 4 pcs



- Bodywork scraper set, 4 pcs
- Dimensions: 90 x 50 mm, 120 x 80 mm, 120 x 105 mm, 120 x 120 mm
- Carbon steel ground blade. Excellent flexibility and maximum durability
- Polished and varnished blade to prevent oxidation
- Supplied in a plastic pouch

22209004B	8413345401333	1		125 g

2485

Trim pad remover

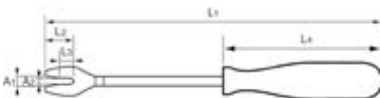

- Used to remove covers, trim or panels at different places in the vehicle
- Features a lever with an special shaped tip
- Blade made of high performance alloy steel
- Hardness: 40-46 HRC
- Handle designed for better grip and user protection
- Retail packed

				A1	A2	L1	L2	L3	L4	
2485	7314150242382	1	16 mm	6.8 mm	240 mm	22.5 mm	10 mm	114 mm	135 g	



BBS200
Trip pad removal pliers

- Special design to facilitate the removal of trim pads, panels, staples, door panels, etc.
- Even in areas with very difficult access
- High performance alloy steel
- Black phosphate finish on the heads
- Nickel & chrome plated finish on the legs

BBS200	7314150239498	1	65 x 75 x 250 mm	215 g



BBS20P12
Trim remover

- Trim and panel remover set
- These tools are used to remove panels and trim without damaging them
- Tools are made of polyamide 6 with 20% glass fibre content
- Prevents damage to trim, mouldings, alloy wheels and vehicle paintwork
- Can be used on trim fasteners or on moulding both inside and outside the vehicle
- Set contains 12 trim tools in different shapes
- Supplied in a foldable pouch for better tool management

BBS20P12	7314150169856	1	35 x 355 x 585 mm	0.690 kg



BBS101
Wire grip handle set

- Provide a fast, reliable and comfortable grip for the operator when cutting out a windscreen using stainless wire
- Safer. The protective tube is specifically designed to prevent injury to the user's hands from contact with the cutting wire
- Steel construction for high durability
- Black PVC handle for increased comfort and a safe and reliable grip
- Retail package with two units

BBS101	7314150243525	1	30 x 80 x 115 mm	0.435 kg



BBS102
T-handle wire pushing tool

- Used to push the wire through the windscreen urethane border
- This tool is inserted underneath the windscreen and below the dashboard
- The operator can choose to push the wire, such as our BBS150R, S or T, from inside the vehicle through the urethane to the outside or push the wire starter through the urethane and then hook the wire through the hole and pull it back inside
- T-handle shape for comfortable use
- Designed with a stainless steel blade
- Plastic injection moulded handle for improved grip
- Use together with wire grips BBS101

BBS102	7314150243518	1	15 x 97 x 265 mm	0.085 kg



BBS103
Wire starter

- Used to push the wire through the windscreen urethane border
- Designed with a slightly curved and pointed stainless steel blade
- High performance alloy steel
- Comfortable handle with straight shape
- Overall length: 350 mm
- Retail packed

BBS103	7314150243488	1	25 x 25 x 345 mm	0.185 kg



BBS105
Windscreen cut-out tool

- Used to cut-out tool for urethane windscreen edges
- Quick release button at the back of the handle for easy blade change, takes only a few seconds
- No screws, nuts or washers to unfasten it
- PVC coated handle and wire tool for improved grip, also prevents collision with body parts during use
- Made of aluminium for very light weight
- Supplied with a 25 mm L-shaped blade
- Available spares BBS107 & BBS108

BBS105	7314150250868	1	20 x 90 x 200 mm	0.330 kg



BBS106
Glass run channel cleaner

- Used to remove the glass pieces remaining in the channel where you place the windscreen
- Specially shaped tip
- Can remove even the most stubbornly wedged pieces of glass
- A professional and safer tool than the commonly used screwdriver
- High performance alloy steel
- Comfortable handle with straight shape
- Overall length: 328 mm
- Retail packed

BBS106	7314150243495	1	25 x 25 x 332 mm	0.145 kg



BBS150
Windscreen cut-out wires

- Used to cut-out wire used to cut out windscreens
- Various wire shapes available: Round and braided, square and triangular
- BBS150S: When a square wire is pulled, pressure is applied to the flat side. It then takes the path of least resistance, rolls over and cuts with the V edges of the wire
- BBS150S: Thickness: 0.6 mm
- BBS150T: triangular wire designed especially for urethane
- BBS150T thickness: 0.6 mm
- BBS150R: The braided design provides the fastest cutting action possible. Quickly slices through urethane and silicone windscreen adhesives. Each braided helix of this wire acts like a cutting saw tooth
- BBS150R. Diameter: 0.3 mm
- Length: 50 m
- Use together with wire grips BBS101

BBS150R	7314150244959	1	x mm			50 m	85 g
BBS150S	7314150244973	1			x	50 m	145 g
BBS150T	7314150244966	1		x		50 m	115 g



BBS3UH

Holder for bodywork shop

- Used to support various kinds of vehicle parts, such as doors, bonnet, tunnels, etc.
- It allows holding parts in many different positions
- The arm and hook positions can be adjusted as required for the best grip
- Once the part is fixed on the rack, it can be rotated to move it or work on it horizontally, vertically, and in many angular positions
- Load capacity: 20 kg
- Equipped with wheels for easy transport
- Rear castors are equipped with a braking system for safely locking the load
- Held part dimensions
- Length: 1160 mm
- Width: 1000 mm
- Height: 1350 mm

BBS3UH	7314150242351	1	950 x 800 x 1200 mm	20 kg	16 kg



BBS3BH1

Universal holder with rubber vacuum pads

- Used to carry or support car parts, such as windshields, tunnels, etc
- Thanks to the four vacuum rubber pads, the parts supported on it will not move when you are working on them
- With the vacuum pads removed, the foam tube protections on the top is ideal for working on windshields or body panels, in order to prevent scratching of the surface
- Maximum load capacity: 170 kg
- Equipped with adjustable chains, it allows a wide range of part sizes. Width: 355 - 930 mm. Height: 710 - 1180 mm
- Length: 945 mm

BBS3BH1	7314150356843	1	955 mm	915 mm	355 mm	1180 mm	710 mm	170 kg	6.4 kg



BBS150

Two double suction cups and belt

- Used to handle the windscreen
- The articulated suction cups allow for a better adjustment to the windscreen curvature.
- This set contains two double rubber suction cups and a ratchet tie down belt
- Maximum capacity: 60 kg
- Belt length: 5 m
- Rubber suction cup diameter: 120 mm
- Distance between rubber suction cup centres: 260 mm
- Belt made of polyester

BBS150	7314150169849	1	100 x 160 x 430 mm	120 mm	1.48 kg

**BBS165****Wiper arm puller set**

- Universal wiper arm puller set
- Includes 2 sets of interchangeable legs for greater versatility
- Covers a large range of vehicles such as Audi, BMW, Chevrolet, Daewoo, Chrysler, Jeep, Citroën, Fiat, Ford, Honda, Hyundai, Kia, Land Rover, Mazda, MG Rover, Nissan, Peugeot, Porsche, Renault, VW, and commercial vehicles such as MAN, MB, Scania, etc.
- Maximum depth: 50 mm
- Operating width: 0–60 mm
- High performance alloy steel

BBS165	7314150205615	10	117 x 25 x 78 mm	0.61 kg

BBS075**Rubber suction cup**

- Used to hold parts with flat clean surfaces
- Ideal tool for moving flat objects such as body panels, bonnets, window panes, windscreens or sheet metal in any professional body shop or home garage
- Can be used as a dent puller
- Maximum capacity: 75 kg
- Rubber suction cup diameter: 165 mm
- Made of EPDM 55



BBS075	7314150249824	12	160 mm	175 mm	75 kg	0.36 kg

5750**Seat cover**

- Individual front seat cover
- Protects vehicle seat upholstery in garages
- Made of sturdy nylon
- Resistant to many workshop substances
- Easily washable
- Retail packed



5750	7311518280949	1	1390 mm	160 g



5770

Multipurpose vehicle front body protector

- Protects front end, bumper and wings avoiding damages to the vehicle body
- It fits and fixes perfectly thanks to the elastic edges and the retaining straps
- Features wheel gaps for wheel/braking maintenance tasks
- Transparent plastic areas allow testing the headlamps
- Reinforced wings area thanks to additional sturdy sheets
- Suitable for the majority of light-medium vehicles
- Made of resistant 100% Polyester (Nylon)
- Resistant to most workshop substances and liquids
- Reusable and easily washable.

5770	7314150504466	12	350 x 300 x 85 mm	990 g

BBS50

Car panel protector

- Car panel protector for protecting vehicle body when performing maintenance tasks
- Large size [900 x 580 mm] to cover and protect a wide vehicle area
- Equipped with magnets and suction pads for stronger fixation
- Ideal for use on aluminium as well as steel
- Made of sturdy PVC fabric
- Easily washable
- Retail packed

BBS50	7314150169863	1	900 mm	1.2 mm	580 mm	0.56 kg





OTHER TOOLS



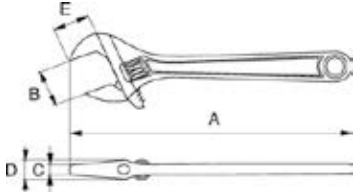

9029 / 9031

Ergotm central nut wide opening jaw adjustable wrenches with rubber handle and phosphate finish

- Adjustable wrenches developed according to the scientific ERGO™ process
- Maximum comfort with minimum effort thanks to ergonomic design
- Extra-wide jaw opening with a shorter handle than a standard wrench offers accessibility to work in confined spaces
- Jaw will not fall out even at maximum opening of the wrench
- Head combines slim design for accessibility with strength for performance
- Laser scale in mm for pre-adjusting and accurate measurement
- Skydrol- and oil-resistant rubber handle
- Ergonomically designed thermoplastic elastomer handle distributes pressure uniformly in the hand, reducing the risk for work related injuries
- High-performance alloy steel forged in single piece
- Phosphate, precision-hardened and anti-corrosion treated
- Left turning screw
- Standards: ISO 6787, DIN 3117, ASME B107.8 and BS 6333

			A	A	B	C	D	E	
9029	7314153010612	5	170 mm	6 in	32 mm	5 mm	12.8 mm	29 mm	220 g
9031	7314150110988	5	218 mm	8 in	38 mm	5 mm	13.4 mm	34 mm	340 g

8069 / 8075

Central nut adjustable wrenches with phosphate finish

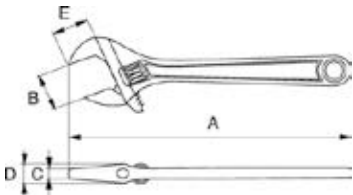

- Jaw does not fall out even at maximum opening of the wrench
- Head combines slim design for accessibility with strength for performance
- Laser scale in mm for pre-adjusting and accurate measurement
- Wide handle for comfort in use
- Accurate jaw movement
- High performance alloy steel forged in single piece
- Phosphate finish, precision-hardened and anti-corrosion treated
- Left turning screw
- Standards: ISO 6787, DIN 3117, ASME B107.8 and BS 6333
- IP: Industrial pack

			A	A	B	C	D	E	
8069	7314150007028	5	110 mm	4 in	13 mm	4 mm	9 mm	13 mm	60 g
8070	7314150007110	5	155 mm	6 in	20 mm	5.3 mm	11.5 mm	19 mm	135 g
8071	7314150007202	5	205 mm	8 in	27 mm	6 mm	13 mm	24 mm	255 g
8072	7314150007288	5	255 mm	10 in	31 mm	8.6 mm	15.5 mm	29 mm	400 g
8073	7314150007363	5	305 mm	12 in	34 mm	11.9 mm	18 mm	34 mm	665 g
8074	7314150007448	3	380 mm	15 in	44 mm	13 mm	21.5 mm	44 mm	1035 g
8075	7314150007523	3	455 mm	18 in	53 mm	17.7 mm	22.5 mm	53 mm	1665 g

111M/SH8

Metric flat combination wrench set - 8 pcs/plastic holder



- Set includes 8 pieces: 8, 10, 12, 13, 14, 17, 19 and 22 mm
- Metric sizes
- Patented U-shaped design
- Open end angle 15° with a slimmer head for improved accessibility
- Larger and bi-directional size marking for easy identification
- 12-point Dynamic-Drive™ profile provides longer life for screws and nuts
- Chrome plated micro-matte finishing provides high quality surface
- High-performance alloy steel
- Standards: ISO 691, ISO 7738, ISO 3318, ISO 1711-1 and DIN 3113
- Available in plastic holder

111M/SH8	7314150197873	1	8	850 g

111M-8, 111M-10, 111M-12, 111M-13, 111M-14, 111M-17, 111M-19, 111M-22



**111M/SH12****Metric flat combination wrench set 8-19 mm - 12 pcs/plastic holder**

- Set includes 12 pieces: 8, 9, 10, 11, 12, 13, 14, 15, 16, 17, 18 and 19 mm
- Metric sizes
- Patented U-shaped design
- Open end angle 15° with a slimmer head for improved accessibility
- Larger and bi-directional size marking for easy identification
- 12-point Dynamic-Drive™ profile provides longer life for screws and nuts
- Chrome plated micro-matte finishing provides high quality surface
- High-performance alloy steel
- Standards: ISO 691, ISO 7738, ISO 3318, ISO 1711-1 and DIN 3113
- Available in plastic holder

				
111M/SH12	7314153013347	1	12	1050 g

111M-8, 111M-9, 111M-10, 111M-11, 111M-12, 111M-13, 111M-14, 111M-15, 111M-16, 111M-17, 111M-18, 111M-19

**111M/11T****Metric flat combination wrench set - 11 pcs/pouch**

- Set includes 11 pieces: 8, 9, 10, 11, 12, 13, 14, 15, 17, 19 and 22 mm
- Metric sizes
- Patented U-shaped shank design
- Open end angle 15° with a slimmer head for improved accessibility
- Larger and bi-directional size marking for easy identification
- 12-point Dynamic-Drive™ profile provides longer life for screws and nuts
- Chrome plated micro-matte finishing provides high quality surface
- High-performance alloy steel
- Standards: ISO 691, ISO 7738, ISO 3318, ISO 1711-1 and DIN 3113
- Available in black plastic pouch

				
111M/11T	7314151828899	1	11	740 g

111M-8, 111M-9, 111M-10, 111M-11, 111M-12, 111M-13, 111M-14, 111M-15, 111M-17, 111M-19, 111M-22

**111M/17T****Metric flat combination wrench set 6-22 mm - 17 pcs/pouch**

- Set includes 17 pieces: 6, 7, 8, 9, 10, 11, 12, 13, 14, 15, 16, 17, 18, 19, 20, 21 and 22 mm
- Metric sizes
- Patented U-shaped shank design
- Open end angle 15° with a slimmer head for improved accessibility
- Larger and bi-directional size marking for easy identification
- 12-point Dynamic-Drive™ profile provides longer life for screws and nuts
- Chrome plated micro-matte finishing provides high quality surface
- High-performance alloy steel
- Standards: ISO 691, ISO 7738, ISO 3318, ISO 1711-1 and DIN 3113
- Available in black plastic pouch

				
111M/17T	7314151828912	1	17	1615 g

111M-6, 111M-7, 111M-8, 111M-9, 111M-10, 111M-11, 111M-12, 111M-13, 111M-14, 111M-15, 111M-16, 111M-17, 111M-18, 111M-19, 111M-20, 111M-21, 111M-22



**111M/26T****Metric flat combination wrench set - 26 pcs/pouch**

- Set includes 26 pieces: 6, 7, 8, 9, 10, 11, 12, 13, 14, 15, 16, 17, 18, 19, 20, 21, 22, 23, 24, 25, 26, 27, 28, 29, 30 and 32 mm
- Metric sizes
- Patented U-shaped shank design
- Open end angle 15° with a slimmer head for improved accessibility
- Larger and bi-directional size marking for easy identification
- 12-point Dynamic-Drive™ profile provides longer life for screws and nuts
- Chrome plated micro-matte finishing provides high quality surface
- High-performance alloy steel
- Standards: ISO 691, ISO 7738, ISO 3318, ISO 1711-1 and DIN 3113
- Available in black plastic pouch

				
111M/26T	7314151828929	1	26	4355 g

111M-6, 111M-7, 111M-8, 111M-9, 111M-10, 111M-11, 111M-12, 111M-13, 111M-14, 111M-15, 111M-16, 111M-17, 111M-18, 111M-19, 111M-20, 111M-21, 111M-22, 111M-23, 111M-24, 111M-25, 111M-26, 111M-27, 111M-28, 111M-29, 111M-30, 111M-32

**111Z/11T****Imperial flat combination wrench set - 11 pcs/black plastic pouch**

- Patented U-shaped design
- Open end angle 15° with a slimmer head for improved accessibility
- Ring end angle 15° for knuckle clearance or better grip
- Larger and bi-directional size marking for easy identification
- 12-point Dynamic-Drive™ profile provides longer life for screws and nuts
- Chrome plated micro-matte finishing provides high quality surface
- High-performance alloy steel
- Standards: ISO 691, ISO 7738, ISO 3318, ISO 1711-1 and DIN 3113
- Available in black plastic pouch



				
111Z/11T	7314151829124	1	11	1660 g

111Z-3/8, 111Z-7/16, 111Z-1/2, 111Z-9/16, 111Z-5/8, 111Z-11/16, 111Z-3/4, 111Z-13/16, 111Z-7/8, 111Z-15/16, 111Z-1



**1RM/SH8****Metric combination ratcheting wrench set - 8 pcs/plastic holder**

- Open end angle 15° with a slimmer head for improved accessibility
- Ring end angle 15° for knuckle clearance or better grip
- Switch for quick change of right and left direction
- Larger and bi-directional size marking for easy identification
- Ratchet in the ring for high productivity application
- 12-point Dynamic-Drive™ profile provides longer life for screws and nuts
- Chrome plated micro-matte finishing provides high quality surface
- High-performance alloy steel
- Faster turning of fastener from the ring end ratcheting action
- Easier to use in confined spaces with 5° operating angle
- Standards: ISO 1711-1 and DIN 3113
- Available in plastic holder

1RM/SH8	7314150223015	1	8	955 g

1RM-8, 1RM-10, 1RM-11, 1RM-12, 1RM-13, 1RM-14, 1RM-17, 1RM-19

**1RM/SH12****Metric combination ratcheting wrench set - 12 pcs/plastic holder**

- Open end angle 15° with a slimmer head for improved accessibility
- Ring end angle 15° for knuckle clearance or better grip
- Switch for quick change of right and left direction
- Larger and bi-directional size marking for easy identification
- Ratchet in the ring for high productivity application
- 12-point Dynamic-Drive™ profile provides longer life for screws and nuts
- Chrome plated micro-matte finishing provides high quality surface
- High-performance alloy steel
- Faster turning of fastener from the ring end ratcheting action
- Easier to use in confined spaces with 5° operating angle
- Standards: ISO 1711-1 and DIN 3113
- Available in plastic holder

1RM/SH12	7314150219780	10	12	1520 g

1RM-8, 1RM-9, 1RM-10, 1RM-11, 1RM-12, 1RM-13, 1RM-14, 1RM-15, 1RM-16, 1RM-17, 1RM-18, 1RM-19

**28M/8****Metric double head offset socket wrench set with 12 x 6-point dynamic-drive™ - 8 pcs**

- 12-point Dynamic-Drive™ profile in offset ring
- 6-point Dynamic-Drive™ profile in straight ring
- Pass-through in offset and deep socket in straight side to use even for long thread bar
- Chrome plated micro-matte finishing provides high quality surface
- High-performance alloy steel
- Standard: ISO 2236
- Available in cardboard box

28M/8	7314151838119	1	8	1990 g

28M-8, 28M-10, 28M-11, 28M-13, 28M-16, 28M-17, 28M-18, 28M-19



**28M/15****Metric double head offset socket wrench set with 12 x 6-point dynamic-drive™ - 15 pcs**

- 12-point Dynamic-Drive™ profile in offset ring
- 6-point Dynamic-Drive™ profile in straight ring
- Pass-through in offset and deep socket in straight side to use even for long thread bar
- Chrome plated micro-matte finishing provides high quality surface
- High-performance alloy steel
- Standard: ISO 2236
- Available in cardboard box

28M/15	7314151838140	1	15	

28M-8, 28M-9, 28M-10, 28M-11, 28M-12, 28M-13, 28M-14, 28M-15, 28M-16, 28M-17, 28M-18, 28M-19, 28M-21, 28M-22, 28M-24

**29M/8****Metric double head offset socket wrench set with 6 x 6-point dynamic-drive™ - 8 pcs**

- 6-point Dynamic-Drive™ profile in offset ring
- 6-point Dynamic-Drive™ profile in straight ring
- Pass-through in offset and deep socket in straight side to use even for long thread bar
- Chrome plated micro-matte finishing provides high quality surface
- High-performance alloy steel
- Standard: ISO 2236
- Available in cardboard box

29M/8	7314150122530	1	8	1850 g

29M-8, 29M-10, 29M-12, 29M-13, 29M-14, 29M-17, 29M-19, 29M-22

**29M/14****Metric double head offset socket wrench set with 6 x 6-point dynamic-drive™ - 14 pcs**

- 6-point Dynamic-Drive™ profile in offset ring
- 6-point Dynamic-Drive™ profile in straight ring
- Pass-through in offset and deep socket in straight side to use even for long thread bar
- Chrome plated micro-matte finishing provides high quality surface
- High-performance alloy steel
- Standard: ISO 2236
- Available in cardboard box

29M/14	7314150122554	1	14	4000 g

29M-11, 29M-12, 29M-13, 29M-14, 29M-8, 29M-9, 29M-10, 29M-16, 29M-17, 29M-21, 29M-22, 29M-19, 29M-24, 29M-23



**BE-9588****Metric long Hex L-key set with phosphate finish and two-component holder - 9 pcs**

- Hexagonal tipped L-key set of 9 pieces, long in metric
- 1.5, 2, 2.5, 3, 4, 5, 6, 8, 10
- Phosphate finish surface treatment provides outstanding surface protection; higher accuracy in the tip
- High quality steel, entirely hardened
- Size stamped in the blade for easy identification
- All sizes branded onto the lid for an easy selection
- Integrated magnet in holder allows magnetizing and demagnetizing when needed
- Two-component compact holder with hanging hole

			PCS/STK		
BE-9588	7314150123810	1	9	1.5, 2, 2.5, 3, 4, 5, 6, 8, 10 mm	435 g

1995LM-1.5, 1995LM-2, 1995LM-2.5, 1995LM-3, 1995LM-4, 1995LM-5, 1995LM-6, 1995LM-8, 1995LM-10

**BE-9678****Metric long ball end Hex L-key set with phosphate finish and two-component holder - 9 pcs**

- Hexagonal tipped L-key set with ball end of 9 pieces, long in metric
- 1.5, 2, 2.5, 3, 4, 5, 6, 8, 10
- Hexagonal ball point on the long arm. Easy to insert in the screw head from a range of angles. For more efficient work and time saver
- Long arm provides higher torque transmission and accessibility
- Phosphate finish surface treatment provides outstanding surface protection; higher accuracy in the tip
- High quality steel, entirely hardened
- Size stamped in the blade for easy identification
- All sizes branded onto the lid for an easy selection
- Two-component compact holder with hanging hole

			PCS/STK		
BE-9678	7314150123827	1	9	1.5, 2, 2.5, 3, 4, 5, 6, 8, 10 mm	430 g

1996M-4, 1996M-5, 1996M-2.5, 1996M-3, 1996M-10, 1996M-6, 1996M-8, 1996M-2, 1996M-1.5

**BE-9785****Imperial long ball end Hex L-key set with phosphate finish - 13 pcs**

- Hexagonal tipped L-key set with ball end of 13 pieces, long in inch
- 0.050, 1/16, 5/64, 3/32, 7/64, 1/8, 9/64, 5/32, 3/16, 7/32, 1/4, 5/16, 3/8
- Hexagonal ball point on the long arm. Easy to insert in the screw head from a range of angles. For more efficient work and time saver
- Long arm provides higher torque transmission and accessibility
- Phosphate finish surface treatment provides outstanding surface protection; higher accuracy in the tip
- High quality steel, entirely hardened
- Size stamped in the blade for easy identification
- All sizes marked on the holder for an easy selection
- Hanging hole
- In plastic holder

			PCS/STK		
BE-9785	7314150056347	3	13	0.05 1/16 5/64 3/32 7/64 1/8 9/64 5/32 3/16 7/32 1/4 5/16 3/8 in	370 g



BE-9787

Imperial Hex folding L-key set 3/32" - 3/8" - 7 pcs



- Hexagonal tipped L-key set of 7 pieces, folding inch
- 3/32, 1/8, 5/32, 3/16, 1/4, 5/16, 3/8
- Black oxide finish provides outstanding surface protection; higher accuracy in the tip
- In high quality impact resistant folder
- Allows many different working positions
- Positive stop at 270° degrees for maximum leverage
- In blister packaging

			PCS/STK		
BE-9787	7314150056569	6	7	3/32 1/8 5/32 3/16 1/4 5/16 3/8 in	410 g



1995M/10T

Metric Hex L-key set with phosphate finish - 10 pcs



- Hexagonal tipped L-Keys set, 10 pieces short in metric
- 2, 2.5, 3, 4, 5, 6, 7, 8, 9, 10
- Phosphate finish surface treatment provides outstanding surface protection; higher accuracy in the tip
- High quality steel, entirely hardened
- Size stamped in the blade for easy identification
- Sizes marked at the top of the wallet for easy identification
- In plastic wallet with hanging hole

			PCS/STK			
1995M/10T	7314150123643	1	10	2, 2.5, 3, 4, 5, 6, 7, 8, 9, 10 mm	10 x 94 x 185 mm	365 g

1995M-2,5, 1995M-2, 1995M-6, 1995M-5, 1995M-4, 1995M-3, 1995M-9, 1995M-10, 1995M-7, 1995M-8



1995M/11T

Metric Hex L-key set with phosphate finish - 11 pcs



- Hexagonal tipped L-Keys set, 11 pieces short in metric
- 2, 2.5, 3, 4, 5, 6, 7, 8, 9, 10, 12
- Phosphate finish surface treatment provides outstanding surface protection; higher accuracy in the tip
- High quality steel, entirely hardened
- Size stamped in the blade for easy identification
- Sizes marked at the top of the wallet for easy identification
- In plastic wallet with hanging hole

			PCS/STK			
1995M/11T	7314150123650	1	11	2, 2.5, 3, 4, 5, 6, 7, 8, 9, 10, 12 mm	10 x 110 x 215 mm	535 g

1995M-2, 1995M-6, 1995M-5, 1995M-4, 1995M-2,5, 1995M-3, 1995M-9, 1995M-10, 1995M-7, 1995M-8, 1995M-12



**1995M/15T****Metric Hex L-key set with phosphate finish - 15 pcs**

- Hexagonal tipped L-Keys set, 15 pieces short in metric
- 2, 2.5, 3, 4, 5, 6, 7, 8, 9, 10, 12, 14, 17, 19, 22
- Phosphate finish surface treatment provides outstanding surface protection; higher accuracy in the tip
- High quality steel, entirely hardened
- Size stamped in the blade for easy identification
- Sizes marked at the top of the wallet for easy identification
- In plastic wallet

			PCS/STK			
1995M/15T	7314150123667	1	15	2, 2.5, 3, 4, 5, 6, 7, 8, 9, 10, 12, 14, 17, 19, 22 mm	25 x 205 x 240 mm	2800 g

1995M-2, 1995M-2,5, 1995M-3, 1995M-4, 1995M-5, 1995M-6, 1995M-7, 1995M-8, 1995M-9, 1995M-10, 1995M-12, 1995M-14, 1995M-17, 1995M-19, 1995M-22

**1995TORX/7T****Long TORX® L-key set with black oxide finish - 7 pcs**

- TORX® tipped L-key set, 7 pieces, long
- T10, T15, T20, T25, T27, T30, T40
- Long arm provides higher torque transmission and accessibility
- Black oxide finish provides outstanding surface protection; higher accuracy in the tip
- High quality steel, entirely hardened
- Size laser marked on the blade for easy identification
- Sizes marked at the top of the wallet for easy identification
- In plastic wallet

			PCS/STK			
1995TORX/7T	7314150123711	1	7	10, 15, 20, 25, 27, 30, 40	10 x 92 x 193 mm	155 g

1995TORX-T20, 1995TORX-T10, 1995TORX-T15, 1995TORX-T27, 1995TORX-T25, 1995TORX-T30, 1995TORX-T40

**1995TORX/11T****Long TORX® L-key set with black oxide finish - 11 pcs**

- TORX® tipped L-key set, 11 pieces, long
- T7, T9, T10, T15, T20, T25, T27, T30, T40, T45, T50
- Long arm provides higher torque transmission and accessibility
- Black oxide finish provides outstanding surface protection; higher accuracy in the tip
- High quality steel, entirely hardened
- Size laser marked on the blade for easy identification
- Sizes marked at the top of the wallet for easy identification
- In plastic wallet

			PCS/STK			
1995TORX/11T	7314150123742	1	11	7, 9, 10, 15, 20, 25, 27, 30, 40, 45, 50	15 x 115 x 220 mm	325 g

1995TORX-T7, 1995TORX-T9, 1995TORX-T10, 1995TORX-T15, 1995TORX-T20, 1995TORX-T25, 1995TORX-T27, 1995TORX-T30, 1995TORX-T40, 1995TORX-T45, 1995TORX-T50





1995TORX/13T

Long TORX® L-key set with black oxide finish - 13 pcs



- TORX® tipped L-key set, 13 pieces, long
- T6, T7, T8, T9, T10, T15, T20, T25, T27, T30, T40, T45, T50
- Long arm provides higher torque transmission and accessibility
- Black oxide finish provides outstanding surface protection; higher accuracy in the tip
- High quality steel, entirely hardened
- Size laser marked on the blade for easy identification
- Sizes marked at the top of the wallet for easy identification
- In plastic wallet

			PCS/STK			
1995TORX/13T	7314150123759	1	13	6, 7, 8, 9, 10, 15, 20, 25, 27, 30, 40, 45, 50	15 x 115 x 220 mm	335 g

1995TORX-T6, 1995TORX-T7, 1995TORX-T8, 1995TORX-T9, 1995TORX-T10, 1995TORX-T15, 1995TORX-T20, 1995TORX-T25, 1995TORX-T27, 1995TORX-T30, 1995TORX-T45, 1995TORX-T40, 1995TORX-T50



903T-1

Hex screwdriver set with T-handle grip - 6 pcs



- T-handle screwdriver set, 6 pieces, for hexagonal head screws
- Hex: 3, 4, 5, 6, 8, 10 mm
- Black oxide tip for higher accuracy
- Two-component soft grip handle provides extra comfort and reduces pressure points in the hand
- Markings on the handle for quick identification of the tip
- Long blade to use as a T-shaped wrench. Provides high-torque transfer. The long blade allows to apply a controlled torque and provides an easy access to screws requiring depth
- The short 90° blade is used for extreme torque or to work in areas where height is limited
- Chrome plated blade for high protection against corrosion
- Integrated hanging hole
- In blister packaging

			PCS/STK		
903T-1	7314153018410	1	6	40 x 240 x 347 mm	855 g

900T-030-100, 900T-040-150, 900T-050-150, 900T-060-200, 900T-080-200, 900T-100-200



903T-2

TorX® screwdriver set with T-handle grip - 6 pcs



- T-handle screwdriver set, 6 pieces, for TORX® head screws
- TORX®: T10, T15, T20, T25, T30, T40
- Black oxide tip for higher accuracy
- Two-component soft grip handle provides extra comfort and reduces pressure points in the hand
- Markings on the handle for quick identification of the tip
- Long blade to use as a T-shaped wrench. Provides high-torque transfer. The long blade allows to apply a controlled torque and provides an easy access to screws requiring depth
- The short 90° blade is used for extreme torque or to work in areas where height is limited
- Chrome plated blade for high protection against corrosion
- Integrated hanging hole
- In blister packaging

			PCS/STK		
903T-2	7314153018427	1	6	40 x 240 x 347 mm	854 g

901T-015-150, 901T-020-150, 901T-010-100, 901T-030-200, 901T-040-200, 901T-025-150



**BE1TH-S6****Set of 6 T-bar handles for allen hex socket head screws 2.5, 3, 4, 5, 6 & 8 mm**

- Set of T-bar handles with hexagonal tips for working on bicycles, motorbikes, cars, trucks, agricultural vehicles, aviation and industrial maintenance workshops
- Designed for reaching difficult areas
- The long bar allows application of controlled torque and provides easy access to screws requiring depth
- Sliding bar with safety pin
- Set contents: 2.5, 3, 4, 5, 6 and 8 mm
- Burnished tips
- Chrome plated finish

BE1TH-S6	7314150344017	30	510 g	6

BE1TH-2.5, BE1TH-3, BE1TH-4, BE1TH-8, BE1TH-6, BE1TH-5

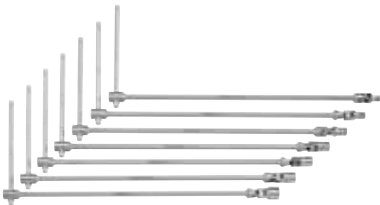
**BE1TS-S7****Set of 7 T-bar handles with swivel sockets 7, 8, 10, 12, 13, 14 & 17 mm 500 mm long**

- Set of T-bar handles with swivel socket designed for working on bicycles, motorbikes, cars, trucks, agricultural vehicles, aviation and industrial maintenance workshops
- Swiveling socket 90°-90° for reaching difficult areas
- The 500 mm long bar allows application of controlled torque and provides easy access to screws requiring depth
- Sliding bar with safety pin
- Set contents: 7, 8, 10, 12, 13, 14 and 17 mm
- Chrome plated finish

BE1TS-S7	7314150344208	1	3460 g	7

BE1TS-17, BE1TS-13, BE1TS-14, BE1TS-12, BE1TS-7, BE1TS-8, BE1TS-10

**B219.010RB****BahcoFit color-coded handle slotted/phillips/pozidriv/torx screwdriver set with rubber grip - 10 pcs**

- Includes 10 screwdrivers
- 0.5 x 3.0 x 75, 0.8 x 4.0 x 100; 1.0 x 5.5 x 100, 1.2 x 6.5 x 125, PH1 x 100, PH2 x 125, PZ1 x 100, PZ2 x 125; T15 x 100; T20 x 100
- Black oxide tip for higher accuracy
- Two-component handle with vertical grooves and large soft-grip area for comfortable grip and high torque transfer
- Easy to choose the right tip with the colour-coded handle
- Handle made with over 75% rubber
- Anti-slip surface
- Permanent symbol and markings on the handle for quick identification of the tip
- Integrated hanging hole
- Chrome plated blade for high protection against corrosion, long life tool
- High performance steel blade
- In cardboard box
- Color-coded handle not available as loose item

B219.010RB	7314150423026	1	10	45 x 170 x 330 mm
				630 g



B147

BahcoFit flexible magnetic pullers with rubber grip



- Two-component handle with vertical grooves for comfortable grip and maximum force transmission, anti-slip surface
- Handle made with over 75% rubber
- Chrome plated and polished blade
- Easy access with the flexible shaft
- SB Retailed packed on a plastic hanger

B147.001.400	7314150285594	1	13 mm	400 mm	30 mm	100 mm	500 mm	160 g	

B219.005

BahcoFit slotted/phillips screwdriver set with rubber grip - 5 pcs

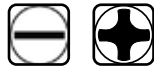

- Includes 5 screwdrivers
- 0.5 x 3.0 x 75, 0.8 x 4.0 x 100, 1.0 x 5.5 x 125, PH1 x 100, PH2 x 125
- Black oxide tip for higher accuracy
- Two-component handle with vertical grooves and large soft-grip area for comfortable grip and high torque transfer
- Handle made with over 75% rubber
- Anti-slip surface
- Permanent symbol and markings on the handle for quick identification of the tip
- Integrated hanging hole
- Chrome plated blade for high protection against corrosion, long life tool
- High performance steel blade
- In cardboard box

B219.005	7314150283255	1	5	38 x 175 x 365 mm	355 g

B191.030.075, B191.040.100

B190.055.125

B192.001.100, B192.002.125

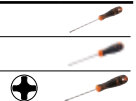

B219.017

BahcoFit slotted/phillips screwdriver set with rubber grip - 7 pcs



- Includes 7 screwdrivers
- 0.6 x 3.5 x 100, 0.8 x 4.0 x 100, 1.0 x 5.5 x 125, 1.2 x 6.5 x 150, 1.6 x 8.0 x 150, PH1 x 100, PH2 x 125
- Black oxide tip for higher accuracy
- Two-component handle with vertical grooves and large soft-grip area for comfortable grip and high torque transfer
- Handle made with over 75% rubber
- Anti-slip surface
- Permanent symbol and markings on the handle for quick identification of the tip
- Integrated hanging hole
- Chrome plated blade for high protection against corrosion, long life tool
- High performance steel blade
- In cardboard box

B219.017	7314150283330	1	7	38 x 220 x 365 mm	530 g

B191.035.100, B191.040.100

B190.055.125, B190.065.150, B190.080.150

B192.001.100, B192.002.125

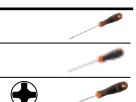

**B219.025****BahcoFit torx® screwdriver set with rubber grip - 5 pcs**

- Includes 5 screwdrivers
- T10 x 75, T15 x 100, T20 x 100, T25 x 125, T30 x 150
- Black oxide tip for higher accuracy
- Two-component handle with vertical grooves and large soft-grip area for comfortable grip and high torque transfer
- Handle made with over 75% rubber
- Anti-slip surface
- Permanent symbol and markings on the handle for quick identification of the tip
- Integrated hanging hole
- Chrome plated blade for high protection against corrosion, long life tool
- High performance steel blade
- In cardboard box

			PCS/STK		
B219.025	7314150283279	1	5	38 x 175 x 365 mm	360 g

B194.010.075, B194.015.100, B194.020.100, B194.025.125, B194.030.150

**B220.005****BahcoFit VDE insulated slotted and phillips screwdriver set with multi-component handle - 5 pcs**

- Includes 5 pieces of insulated VDE screwdrivers
- For work on live equipment, up to 1000 V, high quality blade insulation moulded directly onto the blade
- 0.5x 3.0x 100, 0.8 x 4.0 x 100, 1.0 x 5.5 x 125, PH1 x 80, PH2 x 100
- Black oxide tip for higher accuracy
- Two-component handle with vertical grooves and large soft-grip area for comfortable grip and high torque transfer
- Handle made with over 75% rubber
- Anti-slip surface
- Permanent symbol and markings on the handle for quick identification of the tip
- Integrated hanging hole
- Blade made of high performance alloy steel
- Individually inspected and manufactured according to IEC 60900, tested in a water bath at 10000 V
- In cardboard box

			PCS/STK		
B220.005	7314150283361	1	5	38 x 175 x 365 mm	450 g

B196.030.100, B196.040.100, B196.055.125

B197.001.080, B197.002.100

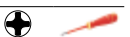



706-1

Slotted/phillips screwdriver set with precision grip 1.5-3.0mm/ph0-ph1 - 6 pcs

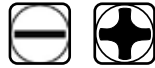

- Includes 6 precision screwdrivers
- 1.5 x 50, 2.0 x 50, 2.5 x 50, 3.0 x 50, PH0 x 50, PH1 x 75
- Black oxide tip for higher accuracy
- Specially designed screwdriver for precision work, especially for mechanical and electronic applications
- Two-component handle with soft grip material for fast and comfortable screw driving
- Cap in different colours and markings on the handle for easy identification of the tip
- Rotating head allows a fast, precise and comfortable finger movement during turning
- High-performance steel blade with chrome-plating for high protection against corrosion
- In plastic case

			PCS/STK		
706-1	7314153018045	1	6	27 x 95 x 227 mm	240 g

700-2-50, 700-2.5-50, 700-1.5-50, 700-3-50

701-0-50, 701-1-75



7823

5/16" Bit set for slotted/ phillips/hex/torx® head screws - 23 pcs



- For slotted, Phillips, hexagonal, TORX® head screws
- Includes 23 pieces: 21 bits, 1 hand operated Impact driver and 1 bit holding adaptor
- SL8, SL10, SL12, PH2, PH3, PH4, T20, T25, T27, T30, T40, T45, T50, T55, HEX4, HEX5, HEX6, HEX8, HEX10, HEX12, HEX14
- To loosening jammed screws or nuts without the use of power tools
- Robust and tough bits
- High performance alloy steel
- Zinc phosphate finish
- 5/16" hexagon drive. DIN 3126, ISO 1173, style C8
- Impact driver for 5/16" bits
- 1/2" adaptor for bits 5/16" hexagon drive
- In metal box

			PCS/STK		
7823	7314150218141	16	23	45 x 70 x 197 mm	1280 g

5521

54640

70S/1.2-8.0, 70S/1.6-10.0, 70S/2.0-12.0

70S/PH2, 70S/PH3, 70S/PH4

70S/T20, 70S/T25, 70S/T27, 70S/T30, 70S/T40, 70S/T45, 70S/T50, 70S/T55

70S/H4, 70S/H5, 70S/H6, 70S/H7, 70S/H8, 70S/H10, 70S/H12, 70S/H14

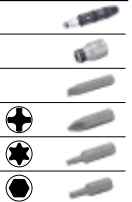

**BE5049T****Bit set with regular torx bits - 49 pcs**

- Complete set of 49 regular sockets and bits for the automotive sector
- Developed together with professional technicians
- Includes 49 pcs in various profiles and sizes
- High performance alloy steel
- Matt chrome plated finish for the sockets
- Zinc phosphate finish for bits
- Hardness according to DIN3126
- Parts list included in the case

BE5049T	7314150325474	1	90 x 205 x 255 mm	3.54 kg

**59/S54BC****1/4" Bit set for slotted/phillips/pozidriv/hex/torx®/torx® tamper/robertson screw - 54 pcs**

- For slotted, Phillips, Pozidriv, hexagonal, TORX®, TORX® tamper, Robertson head screws
- Includes 54 pieces: 51 bits, 1 magnetic universal bit holder, 1 magnetic quick release bit holder and 1 socket adaptor 1/4"
- 25 mm: SL4.5, SL5.5, PH1, PH2 x4, PH3, PH2G x2, PZ1, PZ2 x4, PZ3, T10 x2, T15 x2, T20 x4, T25 x2, T27, T30 x4, T40, TR10, TR15, TR20, TR25, TR30, HEX3, HEX4, HEX5, HEX6, HEX8, Rob
- 1,
- 2 ; 125 mm: PH1, PH2, PZ1, PZ2; 150 mm: T20, T25, T30
- PH2G bits for use with reduced shaft diameter for drywall construction
- TORX® bits are coloured to easy identify the size of the tip
- For universal use
- High performance alloy steel
- Zinc phosphate finish
- 1/4" hex drive DIN 3126 and ISO 1173, style C 6.3
- 1/4" square socket adaptor, ball type for regular nut driver socket (style C 6.3)
- Universal bit holder with strong magnet (style E 6.3)
- Magnetic quick release bit holder with lock in type system (style E 6.3)
- The box is robust, tough and durable and gives a very good protection of the bits

59/S54BC	7314150337613	20	54	50 x 110 x 184 mm	750 g

TORX bits are colored to easy identify the size of the tip





59/S100BC

1/4" Bit set for slotted/phillips/pozidriv/hex/ torx®/torx® tamper/robertson screw - 100 pcs



- For slotted, Phillips, Pozidriv, hexagonal, TORX®, TORX® tamper, Robertson head screws
- Includes 100 pieces: 97 bits, 1 magnetic universal bit holder, 1 magnetic quick release bit holder and 1 socket adaptor 1/4"
- 25 mm: SL4.5, SL5.5, PH1 x2, PH2 x9, PH3, PH2G x5, PZ1 x2, PZ2 x9, PZ3, T10 x3, T15 x5, T20 x15, T25 x8, T27, T30 x15, T40 x3, TR10, TR15, TR20, TR25, TR30, HEX3, HEX4 x3, HEX5, HEX6 x3, HEX8, Rob 1, 2
- PH2G bits for use with reduced shaft diameter for drywall construction
- TORX® bits are coloured to easy identify the size of the tip
- For universal use
- High performance alloy steel
- Zinc phosphate finish
- 1/4" hex drive DIN 3126 and ISO 1173, style C 6.3
- 1/4" square socket adaptor, ball type for regular nut driver socket (style C 6.3)
- Universal bit holder with strong magnet (style E 6.3)
- Magnetic quick release bit holder with lock in type system (style E 6.3)
- The box is robust, tough and durable and gives a very good protection of the bits

			PCS/STK		
59/S100BC	7314150337637	20	100	50 x 110 x 184 mm	857 g

TORX bits are colored

66IM/54C-1

1/4" Impact torsion bit set for slotted/phillips/pozidriv/hex/ torx®/torx® tamper/robertson screws - 54 pcs



- For Phillips, Pozidriv, hexagonal, TORX®, TORX® tamper, Robertson and Slotted head screws
- Includes 54 pieces: 53 Impact bits + 1 Impact resistant magnetic bit holder
- TORX® bits have colored sleeve to easy identify the size of the tip
- Developed for use with impact drivers and suitable for hard material applications
- Designed for long-time works, the Torsion zone can effectively spread the strength concentration
- Torsion zone absorbs torque peaks and makes the bits more wear resistant against sudden impacts (in hard materials or when using an impact driver), preventing the tip from breaking prematurely and improving service life
- High performance alloy steel
- Manganese Phosphate finish
- 1/4" hex drive DIN 3126 and ISO 1173, style C 6.3
- 75 mm magnetic bit holder with lock in type system (style E 6.3)
- Resistant glass fiber reinforced case, tough and durable for good protection of the content
- The patented case has a 180° locking function: case stays in open position even if turned [up to 500g of added weight] without closing on your fingers.
- The lid and body of the case can be split for flexible organizing in trolley drawer or toolkit
- The box is designed to be stacked on top of each other without sliding off, when using multiple sets
- Swiveling racks allow space optimization and easy access to the bits
- Sticker delivered within the set for personalization and user identification
- Delivered in a cardboard sleeve

			PCS/STK		
66IM/54C-1	7314150563364	10	54	45 x 105 x 175 mm	506 g

66IM/PH1-10P, 66IM/PH2-10Px 2, 66IM/PH3-10P		
66IM/PZ1-10P, 66IM/PZ2-10Px 2, 66IM/PZ3-10P		
66IM/T10C-10Px 2, 66IM/T15C-10Px 2, 66IM/T20C-10Px 3, 66IM/T25C-10Px 3, 66IM/T30C-10Px 2, 66IM/T40C-10P		
66IM/50PH1-10P, 66IM/50PH2-10Px 2, 66IM/50PH3-10P		
66IM/50PZ1-10P, 66IM/50PZ2-10Px 2, 66IM/50PZ3-10P		
66IM/50T10C-10P, 66IM/50T15C-10P, 66IM/50T20C-10Px 2, 66IM/50T25C-10Px 2, 66IM/50T30C-10Px 2, 66IM/50T40C-10P		
66IM/KM75-1P		

**66IM/40C-1****1/4" Impact torsion bit set for phillips/pozidriv/torx®/hex head screws - 40 pcs**

- For Phillips, Pozidriv, TORX®, hex head screws.
- Includes 40 pieces: 34 impact bits + 1 slim impact resistant magnetic quick release bit holder + 4 impact torsion magnetic nut drivers + 1 impact torsion hex drive socket adaptor
- TORX® bits have colour-coded sleeves for easy tip size identification
- Developed for use with impact drivers and suitable for hard material applications.
- Designed for long-term use, the torsion zone can effectively spread the force concentration.
- Torsion zone absorbs torque peaks and makes bits more resistant to sudden impacts, preventing premature tip breakage and improving service life.
- High performance alloy steel
- Manganese phosphate finish
- 1/4" hex drive DIN 3126 and ISO 1173, style C 6.3
- 75 mm magnetic quick release bit holder with lock in system (style E 6.3)
- Sturdy glass fibre-reinforced case, tough and durable for good protection
- The patented case has a 180° locking feature and stays open even if turned, without closing on your fingers.
- The case lid and body can be split for flexible organizing in a trolley drawer or toolkit.
- The boxes are designed to be stacked on top of each other without sliding when using multiple sets.
- Swiveling racks for space optimization and easy access
- Sticker included in set for personalization and user identification
- Supplied in a cardboard sleeve.

			PCS/STK		
66IM/40C-1	7314150548385	10	40	45 x 105 x 175 mm	607 g
66IM/PZ2-2P					
66IM/T10C-2P, 66IM/T15C-2P, 66IM/T20C-2P, 66IM/T25C-2P, 66IM/T30C-2P					
66IM/50PH1-2P, 66IM/50PH2-2P, 66IM/50PH3-2P					
66IM/50PZ1-2P, 66IM/50PZ2-2P, 66IM/50PZ3-2P					
66IM/50T10C-2P, 66IM/50T15C-2P, 66IM/50T20C-2P, 66IM/50T25C-2P, 66IM/50T27C-2P, 66IM/50T30C-2P, 66IM/50T40C-2P					
66IM/90T15C-2P, 66IM/90T20C-2P, 66IM/90T25C-2P, 66IM/90T30C-2P, 66IM/90T40C-2P					
66IM/KM75QR-1P					
66IM/K50-1/4-1P					
66IM/M50-8-1P, 66IM/M50-10-1P, 66IM/M50-11-1P, 66IM/M50-13-1P					





59S/54C-1

1/4" Bit set for slotted/phillips/pozidriv/hex/ torx®/torx® tamper/robertson screws - 54 pcs



- For Phillips, Pozidriv, Hexagonal, TORX®, TORX® tamper, Robertson and Slotted head screws
- Includes 54 pieces: 53 Standard bits + 1 magnetic bit holder
- TORX® bits have colored sleeve to easy identify the size of the tip
- For universal use
- High performance alloy steel
- Zinc phosphate finish
- 1/4" hex drive DIN 3126 and ISO 1173, style C 6.3
- Reduced-shank 50mm bits provides enhanced accessibility
- 75 mm Hex universal magnetic bit holder with retaining ring (style E 6.3)
- Resistant glass fiber reinforced case, tough and durable for good protection of the content
- The patented case has a 180° locking function: case stays in open position even if turned [up to 500g of added weight] without closing on your fingers
- The lid and body of the case can be split for flexible organizing in trolley drawer or toolkit.
- The box is designed to be stacked on top of each other without sliding off, when using multiple sets
- Swiveling racks allow space optimization and easy access to the bits
- Sticker delivered within the set for personalization and user identification
- Delivered in a cardboard sleeve

Product Code	SKU	Quantity	PCS/STK	Dimensions	Weight
59S/54C-1	7314150563395	10	54	45 x 105 x 175 mm	556 g
59S/PH1-10P, 59S/PH2-10Px 2, 59S/PH3-10P					
59S/PZ1-10P, 59S/PZ2-10Px 2, 59S/PZ3-10P					
59S/0.8-5.5-3P					
59S/T10-10Px 2, 59S/T15-10Px 2, 59S/T20-10Px 3, 59S/T25-10Px 3, 59S/T30-10Px 2, 59S/T40-10P					
59S/TR10-5P, 59S/TR15-5P, 59S/TR20-5Px 2, 59S/TR25-5Px 2, 59S/TR30-5P					
59S/H2-5P, 59S/H2.5-5P, 59S/H4-5P, 59S/H5-5P, 59S/H6-5P					
59S/R1-3P, 59S/R2-3P					
59S/50PH1-5P, 59S/50PH2-5Px 2, 59S/50PH3-5P					
59S/50PZ1-5P, 59S/50PZ2-5Px 2, 59S/50PZ3-5P					
59S/50T10-5P, 59S/50T15-5P, 59S/50T20-5Px 2, 59S/50T25-5Px 2, 59S/50T30-5Px 2, 59S/50T40-5P					
KMR753					

481F

German din hammer fiberglass handle



- German DIN locksmith's hammer for use on metal
- For mechanics, general purpose
- High-quality tool designed for professionals
- Octagonal neck
- Fibreglass handle for maximum shock absorption
- Special symmetric handle design
- Standard: DIN 1041

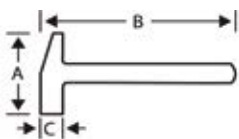

Product Code	SKU	Quantity	Weight	A	B	C	Weight
481F-100	7314150442072	6	100 g	80 mm	260 mm	15 mm	140 g
481F-200	7314150442089	4	200 g	92 mm	260 mm	18 mm	230 g
481F-300	7314150442096	6	300 g	103 mm	300 mm	22 mm	360 g
481F-400	7314150442102	6	400 g	108 mm	300 mm	24 mm	450 g
481F-500	7314150442119	6	500 g	115 mm	300 mm	27 mm	590 g
481F-800	7314150442126	6	800 g	127 mm	350 mm	33 mm	990 g
481F-1000	7314150442133	6	1000 g	135 mm	350 mm	35 mm	1210 g
481F-1500	7314150442140	4	1500 g	145 mm	380 mm	42 mm	1630 g
481F-2000	7314150442157	4	2000 g	153 mm	405 mm	47 mm	2220 g

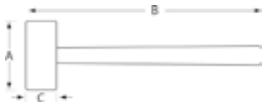
**3625AR****Anti rebound hammers with wooden handle**

- Made of PU (polyurethane)
- Wooden handle spares available (3625-ARHL-xx)
- Nylon tip mallet spares available (3625-ARL-xx)

			A	B	C	g
3625AR-35	7314150214723	34	105 mm	325 mm	35 mm	550 g
3625AR-50	7314150214730	18	115 mm	355 mm	50 mm	1430 g
3625AR-60	7314150214747	12	123 mm	425 mm	60 mm	1550 g

**3625PU****Dead blow sledge hammers with anti-sliding handle**

- With steel structure and PU (polyurethane) layer
- Anti-sliding handle
- Steel shot in head minimizes rebound and more driving power
- Force of strike is transferred to object, decreasing shock to the user, reducing wrist and arm fatigue
- Non-sparking and low noise
- Increased surface protection
- Ideal for tyre change and transmission work
- Suitable for mould production, wooden furniture, gas, chemical engineering, petroleum, gunpowder, sheet metal, aviation ships, sailing etc.
- Striking area not marked
- Adapts to temperatures from -20 °C to 90 °C
- Hardness: 83 to 86 shore A

			A	B	C	g	
3625PU-30	7311518276119	12	87 mm	300 g	280 mm	35 mm	400 g
3625PU-50	7311518276126	6	100 mm	790 g	320 mm	50 mm	790 g
3625PU-60	7311518276133	6	121 mm	1080 g	365 mm	60 mm	1270 g

3736S/6**Mixed chisel set with lacquered copper finish - 6 pcs/box**

- Set includes 6 pieces: 2 x 3756, 1 x 3735, 1 x 3749 and 2 x 3733
- Safety impact head
- High-performance alloy steel
- Lacquered, copper-coloured finish
- Available in lacquered metal box, anthracite colour



			g
3736S/6	7314151834463	5	840 g
3735-4-120, 3735-5-150			
3733-3			
3749-125			
3756-125, 3756-150			

**3735NS/4****Centre punch set with chrome finish - 4 pcs/wallet**

- Set includes 4 pieces: 3735N-2-100, 3735N-4-120, 3735N-6-150 and 3735N-8-150
- Hexagonal shank
- Fully polished steel surface, with brilliant chrome finishing
- High-performance alloy steel
- Packed in a wallet

3735NS/4	7314150218004	25	340 g

3735N-6-150, 3735N-8-150, 3735N-2-100, 3735N-4-120

1157**Automatic centre punches with hardened steel point**

- Hardened steel point
- Strikes blow when pressure is applied
- No hammer needed
- Clip for pocket storage



			L		b	
1157	7311518277031	60	130 mm	2 mm	15 mm	45 g

3734NS/9**Cylindrical drift punch set with hexagonal shank - 9 pcs/wallet**

- Set includes 9 pieces: 3734N-2-150, 3734N-3-150, 3734N-4-150, 3734N-5-150, 3734N-6-150, 3734N-7-150, 3734N-8-150, 3734N-9-150 and 3734N-10-150
- Hexagonal
- Chrome finish
- Safety impact head
- High performance alloy steel
- Available in wallet
- Set



3734NS/9	7314150218134	10	750 g

3734N-10-150, 3734N-9-150, 3734N-8-150, 3734N-7-150, 3734N-6-150, 3734N-5-150, 3734N-4-150, 3734N-3-150, 3734N-2-150

3734S/6**Cylindrical drift punch set with octagonal shank - 6 pcs/box**

- Set includes 6 pieces: 3734-2, 3734-3, 3734-4, 3734-5, 3734-6 and 3734-8
- Hexagonal
- Safety impact head
- High-performance alloy steel
- Available in lacquered metal box, anthracite colour



3734S/6	7314151834470	5	720 g

3734-2, 3734-3, 3734-4, 3734-5, 3734-6, 3734-8

**3734BMS/7****Cylindrical pin punch set with dual-component handle - 7 pcs/plastic tray**

- Set includes 7 pieces: 3734BM-2, 3734BM-3, 3734BM-4, 3734BM-5, 3734BM-6, 3734BM-8 and 3734BM-10
- Cylindrical
- Hardness 56 HRC to 58 HRC
- Guarded
- 58CrV4
- Two-component handle
- Available in a plastic tray

3734BMS/7	7314150220755	1	900 g

3734BM-2, 3734BM-3, 3734BM-4, 3734BM-5, 3734BM-6, 3734BM-8, 3734BM-10

**3654BMS/7****Mixed mason's chisel set with dual-component handle - 7 pcs/plastic tray**

- Set includes 7 pieces: 3734BM-2, 3734BM-4, 3734BM-5, 3734BM-6, 3654BM-15, 3654BM-20 and 3755BM-6
- End hardness 52 HRC to 58 HRC
- Strike end hardness 35 HRC to 46 HRC
- Two-component handle with guard
- Available in a plastic tray

3654BMS/7	7314150220816	1	920 g

3734BM-2, 3734BM-4, 3734BM-5, 3734BM-6, 3654BM-15, 3654BM-20, 3755BM-6

**6221D-6225D****Box joint water pump pliers with pvc handle**

- Box joint water pump pliers with PVC dipped handles
- Sturdy box joint frame and slim designed PVC dipped handles
- High performance alloy steel
- Phosphate finish, anti-corrosion treated
- Up to 35% bigger mouth opening compared to market standard
- Narrow design head for great accessibility in confined spaces
- Hardened teeth (60 HRC to 62 HRC) for a long product life and strong gripping on any shape
- Designed to prevent fingers being pinched
- ISO 8976
- IP: Industrial packed

			A	B	C	D	E	F			
6223D	7314150421558	8	10	200 mm	25 mm	40 mm	12 mm	6 mm	6 mm	44 mm	185 g
6224D	7314150421565	5	11	250 mm	30 mm	50 mm	13 mm	8 mm	7 mm	61 mm	317 g
6225D	7314150421572	10	13	300 mm	36 mm	55 mm	13 mm	8 mm	7 mm	66 mm	397 g

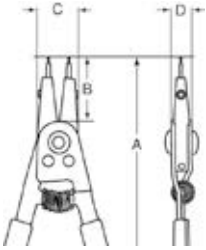

2928

Internal and external circlips reversible pliers

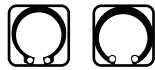

- Adjustable circlip pliers for both internal and external circlips
- Ring diameter: 7-26 mm to 46-102 mm
- Eyelet diameter: 3-26 mm to 32-102 mm
- Tip diameter: 0.6 mm to 1.8 mm
- Circlip tip 90°: 0.9 mm to 3 mm
- Circlip tip 15°: 2.3 mm to 3 mm
- With interchangeable tips
- Patented pliers, equipped with interchangeable tips (straight, 15° and 90°) which can easily be adapted for use with internal or external circlips
- 5 Pairs of tips are supplied with the -160 and -200 and 6 pairs with the -250
- Valid for internal circlips from 8 to 100 mm diameter and for external circlips from 3 to 100 mm
- The 2928-160 pliers, which thus covers a range of applications previously embraced by as many as 10 conventional pliers
- Regulation stop mechanism for easier use and prevention of damage to circlips due to excessive force

			A	B	C	D									
2928-160	7314150056514	1	160 mm	23.5 mm	21.5 mm	17 mm	7-26 mm	3-26 mm	0.6	0.9	1.2 mm	0.9	1.2 mm	120 g	
2928-200	7314150056521	1	200 mm	32 mm	23.5 mm	20 mm	10-51 mm	7-51 mm	0.9	1.2	1.8 mm	0.9	1.2 mm	230 g	
2928-250	7314150056538	1	250 mm	36 mm	30 mm	22 mm	46-102 mm	38-102 mm	2.3	2.7	3.0 mm	2.3	2.7	3.0 mm	505 g

9938

Reversible circlip pliers set - 3 pcs



- Set includes: 2928-160, 2928-200, 2928-250 circlip pliers
- Set of three circlip pliers with interchangeable tips for both internal and external circlips in a plastic box
- Patented pliers, equipped with interchangeable tips (straight, 15° and 90°) which can easily be adapted for use with internal or external circlips
- 5 Pairs of tips are supplied with the -160 and -200 and 6 pairs with the -250
- Valid for internal circlips from 8 to 100 mm diameter and for external circlips from 3 to 100 mm
- Regulation stop mechanism for easier use and prevention of damage to circlips due to excessive force
- The 2928-160 pliers, which thus covers a range of applications previously embraced by as many as 10 conventional pliers

9938	7314150056491	1	PCS/STK	3	52 x 240 x 345 mm	1640 g

2928-160, 2928-200, 2928-250



28-29/S4

Internal and external circlip pliers set - 4 pcs



- Available in a cardboard box
- 2800-180 internal circlip pliers, 180 mm, 19 mm to 60 mm
- 2890-180 internal circlip pliers, 180 mm, 19 mm to 60 mm
- 2900-180 external circlip pliers, 180 mm, 19 mm to 60 mm
- 2890-180 external circlip pliers, 180 mm, 19 mm to 60 mm

28-29/S4	7314150179688	1	PCS/STK	4	30 x 220 x 260 mm	740 g

2900-180



2800-180



2990-180



2890-180

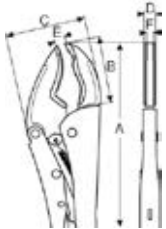

**2957-250****Grip and welding pliers with multipurpose jaws**

- Gripping capacity of 63 mm
- Chrome finish for good rust protection
- Multi-shape holding grip
- Universal, multipurpose tool
- Good grip on round, square and profiled parts
- For holding L, U and T profiles in building or maintenance work
- Able to hold large pieces inside the jaws
- Adjustable locking power, fixing nut and easy to unlock

			A	B	C	D	E	F		
2957-250	7314150102259	1	250 mm	46 mm	56 mm	11 mm	10 mm	11 mm	63 mm	550 g

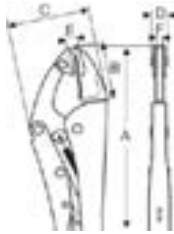
**2955-250****Grip locking pliers with parallel jaws**

- 45 mm gripping capacity
- Chrome finish for good rust protection
- Self adjusting grip
- Parallel jaws, one is self-adjusting with swivel jaw
- Good grip on flat parts
- For holding L, U and T profiles in building or maintenance work
- Able to hold large pieces inside the jaws
- Adjustable locking power, fixing nut easy to unlock
- Enables parallel clamping to any size within its capacity
- Fully flat contact makes it perfect for maintenance and repair work, the extra inner jaws also make it possible to grip round work pieces

			A	B	C	D	E	F		
2955-250	7314150102235	1	235 mm	53 mm	59 mm	12 mm	7 mm	12 mm	45 mm	650 g

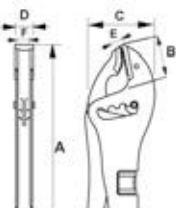
**2997-250****Universal grip pliers with 4 positions short jaws**

- Chrome finish for good rust protection
- Short jaws
- 1 flat jaw, 1 convex jaw
- Shape: flat and convex jaws that can be adjusted to 4 different positions for an increased gripping capacity
- Better grip on flat parts, maximum contact
- For holding L, U and T profiles in building or maintenance work
- Accurate size adjusting ring
- Quick adjustment, easy to unlock

			A	B	C	D	E	F		
2997-250	7314150124237	1	235 mm	38 mm	58 mm	17 mm	14 mm	15 mm	15 mm	550 g

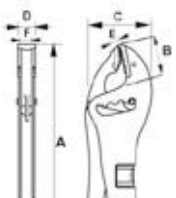
**2997-300****Universal grip pliers with 4 positions long jaws**

- Chrome finish for good rust protection
- Wide locking section
- Extra long jaws with twice as large gripping capacity compared to standard model
- Shape: flat and convex jaws that can be adjusted to 4 different positions for an increased gripping capacity
- Better grip on flat parts, maximum contact
- For holding L, U and T profiles in building or maintenance work
- Accurate size adjusting ring
- Easy to unlock

			A	B	C	D	E	F		
2997-300	7314150124244	5	255 mm	68 mm	64 mm	17 mm	15 mm	15 mm	15 mm	680 g

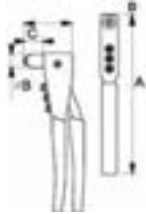
**1467-250****Hand riveters with exchangeable heads**

- Rivet size capacity: 2.4 mm, 3.2 mm, 4 mm and 4.8 mm
- Riveter for general duty

			A	B	C	D	
1467-250	7314150124268	1	255 mm	22 mm	34 mm	75 mm	520 g

**1468-M10****Nut riveter**

- Two-hand use
- To install rivet nuts in metal panels.
- Installation from front side - no need for access to rear side.
- For M4, M5, M6, M8 and M10 rivet nuts
- Includes 5 nut inserts and changing wrench

1468-M10	7314150243228	6	50 x 210 x 575 mm	2720 g

**1468-M6****Nut riveter**

- To install rivet nuts in metal panels.
- Installation from front side - no need for access to rear side.
- For M3, M4, M5 and M6 rivet nuts
- Includes 4 nut inserts and changing wrench

1468-M6	7314150243211	1	20 x 110 x 265 mm	740 g

**1467-520****Long arm riveters with transparent tube collects**

- Rivet size capacity 3.2 mm, 4 mm, 4.8 mm, 6 mm, 6.4 mm
- Two hands use
- Riveter with long handles for greater leverage
- To be used with aluminium, steel and stainless steel rivets
- The transparent plastic container collects the discarded rivet nail

			A	B	C	D	
1467-520	7314150124275	1	530 mm	22 mm	58 mm	160 mm	2020 g

**BPBLS4****Long pry bar set with rubber grip**

- Set includes: BPBL00900, BPBL30900, BPBL70600 and BPBL90600
- BPBL00900 Tip angle: 0°, length: 900 mm
- BPBL30900 Tip angle: 30°, length: 900 mm
- BPBL70600 Tip angle: 70°, length: 600 mm
- BPBL90600 Tip angle: 90°, length: 600 mm
- High-performance alloy steel with 225 mm² section
- Chrome plate finish
- Durable two-component, made of PP+TPR, handle for a better grip and protect the end user
- Metal cap to allows pry bar to be hit by a hammer
- Long pry bars set for easy prying and bending
- Each pry bar has different tip angles to adapt to different working situations, offering anti-slip performance
- These pry bars have great length for achieving a higher torque with less effort and for providing accessibility to deep areas within the vehicle

BPBLS4	7314150360475	2	78 x 255 x 1000 mm	9050 g

BPBL00900, BPBL30900, BPBL70600, BPBL90600

**BT10P3****Multi-position ratcheting pry bar set**

- Used to remove and adjust seals, bearings and manifolds, as well as drive shafts, axles and fuel injectors
- The head can be adjusted to 14 positions
- The position can be easily adjusted through a push button in the handle that controls the locking and releasing mechanism of the head
- Set contents: 3 different sized pry bars
- 250 mm [ref. BT10P325]
- 300 mm [ref. BT10P330]
- 380 mm [ref. BT10P338]
- High performance alloy steel
- Black phosphate finish
- Supplied in a blow moulded case, in plastic inlay for better tool management
- Also available individually

BT10P3	7314150205639	1	375 mm	270 mm	80 mm	2.34 kg

2484T/S4**4 Pcs flat head pry bars with through blade for hammering**

- Powerful tool for demanding jobs
- Through blade for hammering. Additional metal cap.
- Chrome molybdenum blade. Hardness 48 HRC
- Black finish blade
- Handle in polypropylene (PP) and thermoplastic rubber (TPR)

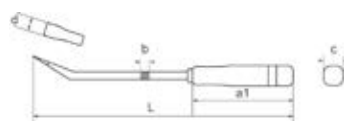

2484T/S4	7314150455096	1	42 x 145 x 693 mm	1950 g

2484T-20, 2484T-30, 2484T-45, 2484T-60

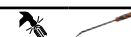

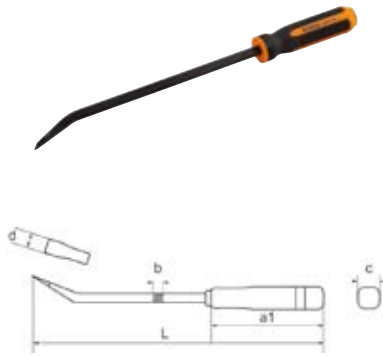
**2484T-20/2484T-60****Flat head pry bar with through blade for hammering**

- Powerful tool for demanding jobs
- Through blade for hammering. Additional metal cap.
- Chrome molybdenum blade. Hardness 48 HRC
- Black finish blade
- Handle in polypropylene (PP) and thermo plastic rubber (TPR)

				L	d	b	a1	C	
2484T-20		7314150455102	1	210 mm	10.6 mm	6.4 mm	111 mm	30 mm	140 g
2484T-30		7314150455119	1	312 mm	15.3 mm	9.5 mm	126 mm	35 mm	325 g
2484T-45		7314150455126	1	465 mm	18.8 mm	11.1 mm	150 mm	35 mm	545 g
2484T-60		7314150455133	1	615 mm	18.8 mm	11.1 mm	150 mm	35 mm	690 g

**BWTSP6****Twist socket set 1/2" 17, 19, 21, 22, 24 mm**

- Wheel twist socket set designed for unfastening damaged nuts and bolts, and especially for locking wheel nuts
- The special spiral profile on the inside enables the socket to grip sufficiently for loosening in cases where standard sockets and wrenches fail
- Drive: 1/2"
- Black phosphate finish
- High performance alloy steel
- Hardness: 45-48 HRC
- Not suitable for machine operation
- Includes 5 different sockets: 17, 19, 21, 22 and 24 mm and a punch
- Also available individually

BWTSP6		7314150240043	1	217 mm	105 mm	55 mm	0.9 kg

BWTSP619, BWTSP617, BWTSP622, BWTSP621, BWTSP624



**BWTSP7****Twist socket set**

- Designed for unfastening damaged nuts and bolts, and especially for locking wheel nuts
- The special spiral profile on the inside enables the socket to grip sufficiently for loosening in cases where standard sockets and wrenches fail
- Drive: 1/2" or 3/4", depending on the profile dimension
- Black phosphate finish
- High performance alloy steel
- Hardness: 50-53 HRC
- Not suitable for machine operation
- Includes 6 different sockets: 22, 24, 27, 32, 36 and 41 mm and a punch
- Also sold individually

BWTSP7	7314150170302	1	117 mm	207 mm	52 mm	1.69 kg

1/2": 22, 24, 27, 32 mm & 3/4": 36, 41 mm

**BWTSP16****Twist socket set**

- Wheel twist socket set designed for unfastening damaged nuts and bolts, and especially for locking wheel nuts
- The special spiral profile on the inside enables the socket to grip sufficiently for loosening in cases where standard sockets and wrenches fail
- Drive: 3/8" or 1/2", depending on the profile dimension
- Black phosphate finish
- High performance alloy steel
- Hardness: 45-48 HRC
- Not suitable for machine operation
- 14 available dimensions. 3/8" drive: 8, 10, 11, 12, 13, 14, 16, 17, 18 and 19 mm. 1/2" drive: 21, 22, 24 and 27 mm
- Set also includes an adaptor: 1/2" female to 3/8" male, and a punch
- Sockets also available individually

BWTSP16	7314150170296	1	245 mm	125 mm	48 mm	1.67 kg

3/8": 8, 10, 11, 12, 13, 14, 16, 17, 18, 19 mm & 1/2": 21, 22, 24, 27 mm



B8SS2	7314150247271	179	BH28050	7314150472222	48	BOD60	7314150169481	106	BWTVCTT355	7314150347779	114
B8SS2L	7314150247295	179	BH33000	7314150178674	49	BOD6080P12	7314150235407	109	BWXW1	7314150167661	112
B8T20	7314150166961	95	BH36000	7314150178681	49	BOD70	7314150169498	106	BWXW2	7314150167678	112
B8T60A	7314150504169	95	BH3HD12000	7314150170500	50	BOD8901	7314150169016	102	BWXW3	7314150214624	112
B8T80	7314150327805	96	BH3HD16000	7314150170524	50	BOD8901AC1	7314150178490	103	BWXW4	7314150214631	112
BDACM1000	7314150500819	98	BH3HD20000A	7314150337668	50	BOD8902	7314150169023	102	D/S14	7311518280314	141
BE1200P6	7314150205516	84	BH3HD8000	7314150170494	49	BOD8903A	7314150265374	102	DD/S14	7311518280338	141
BE1205	7314150205554	84	BH4812	7314150557806	49	BP115	7314150134991	128	FFIA1011	7314150339068	33
BE1210P11	7314150209101	85	BH482	7314150557820	49	BP125A	7314150427291	133	FFIA170	7314150351800	33
BE1300	7314150205578	81	BH4820	7314150557844	49	BP127	7314150137565	129	FFIA2301	7314150286508	34
BE1311P13	7314150235414	80	BH4830	7314150557783	49	BP12718	8414909179002	129	FFIA4003	7314150286706	33
BE1315P7	7314150205776	80	BH485	7314150557868	49	BP218	7314150170272	134	FFIASET-AUTO12A	7314150506446	35
BE1320S17	7314150415366	80	BH488	7314150557882	49	BP219	7314150235889	134	FM10	7311518010881	181
BE132L11	7314150239733	81	BH4G12	7314150557905	48	BP219L	7314150235896	134	FM12	7314150273249	181
BE1FFWF	7314150403325	108	BH4G2	7314150557929	48	BP219XL	7314150427192	134	HRFM10	7311518010898	181
BE1GP5	7314150170043	82	BH4G20	7314150557943	48	BP233	7314150134748	132	K7800M/13	7314150437221	142
BE1GPs-T	7314150170050	82	BH4G4	7314150557967	48	BP254	7314150137633	134	K7806M/S4	7314151813222	142
BE1P	7314150170067	83	BH4G50	7314150557981	48	BP255	7314150137640	134	K78062/10	7314150165025	141
BE1SP14L	7314150170074	82	BH4G6	7314150558001	48	BP601	7314150134526	129	K8901Z/18	7314150436514	143
BE1SP16L	7314150492756	82	BH4G8	7314150558025	48	BP610	7314150134595	129	K8906M/8	7314150165056	142
BE1T4	7314150167630	83	BH5DP1000QA	7314150270224	51	BP700	7314150134458	128	K8906Z/8	7314150165063	143
BE1T16	7314150167647	83	BH5SP5000A	7314150270217	51	BP799	7314150134502	133	K9506M-22	731151844998	144
BE1T21	7314150167654	83	BH5US1000	7314150243174	51	BP821	7314150134472	128	K9506M-24	7314151802530	144
BE1TH-S6	7314150344017	197	BH6AC1-680A	7314150433544	52	BP822	7314150134984	128	K9506M-27	7314151802547	144
BE1T5-S7	7314150344208	197	BH6FC1000	7314150178650	52	BP822E	7314150184279	128	K9506M-30	7314151802554	144
BE256P3	7314150205868	86	BH6FC2000	7314150234639	52	BP823	7314150135004	129	K9506M-32	7314151802561	144
BE400P24	7314150205806	79	BH7100A	7314150345908	57	BP825	7314150134496	130	K9506M-33	7314151802578	144
BE410	7314150205813	79	BH71005G	7314150299782	58	BP828	7314150427260	131	K9506M-34	7314151845018	144
BE5049T	7314150325474	201	BH715	7314150237555	56	BP901	7314150336012	127	K9506M-36	7314151802585	144
BE5100	7314150205646	86	BH720	7314150235650	56	BP901L	7314150336029	127	K9506M-38	7314151802592	144
BE513201	7314150274802	84	BH7205G	7314150238477	57	BP910	7314150427246	132	K9506M-41	7314151802608	144
BE5200	7314150205905	79	BH730	7314150235667	56	BPBL54	7314150360475	211	K9506M-46	7314151802615	144
BE5400P	7314150245086	78	BH7305G	7314150238484	57	BPC813	7314150296408	126	K9506M-50	7314151802622	144
BE5401D	7314150245062	78	BH750	7314150235674	56	BPC814	7314150296392	126	K9506M-55	7314151802639	144
BE6110	7314150167449	107	BH7505G	7314150238491	57	BPC815	7314150296385	127	K9506M-60	7314151802646	144
BE6110-1	7314150167463	107	BH7PS30	7314150474882	57	BPC815K2	7314150331215	126	LARGE	7314150437429	14
BE61155	7314150167456	107	BH8AC1-500	7314150170463	53	BPC817	7314150296422	127	MONSTER	7314150437405	23
BE61155-1	7314150167470	107	BH8AC2-500	7314150412532	59	BPCEV1	7314150384792	120	S0810L	7314150256594	146
BE62110	7314150403332	107	BH8AC3-1500A	7314150516391	54	BPH310A	7314150330003	135	S1214L	7314150256600	150
BE62155	7314150403349	107	BH8AC3-600	7314150351893	54	BPHRC1015	7314150247400	135	S160	7314150104031	148
BE6217	7314150169702	104	BH88C1	7314150242276	174	BPHRC1020	7314150247417	135	S160AF	7314150137510	148
BE630	7314150169580	109	BH88C2	7314150242283	174	BPHRC1316	7314150247455	135	S1612L	7314150256617	154
BE6302712F	7314150412846	108	BH88C3	7314150242290	175	BPHVLP01	7314150138937	133	S18HEX	7314150412457	156
BE63064514F1	7314150340095	108	BH88C4	7314150242306	175	BPNO10	7314150219728	133	S18TORX	7314150412464	156
BE63064514F2	7314150340101	109	BH88C5	7314150242313	175	BS15	7314150206117	123	S240	7314150104017	156
BE6307414F	7314150370108	109	BH8PR10000	7314150178957	174	BS25	7314150416103	123	S240AF	7314150110717	157
BE64350	7314150169672	107	BH8PR4000	7314150178940	174	BS30AC1	7314150383504	122	S240-SPL	7314150549009	157
BE64520	7314150169665	107	BHV1S06100	7314150167753	139	BS30P6	7314150436644	123	S290	731415300859	149
BE65F65120	7314150169658	110	BHV1S06105	7314150167760	139	BS40VAG	7314150430642	122	S330	7314150104024	151
BE65R106160	7314150170036	110	BHV1S0670	7314150167692	139	BS52	7314150329212	121	S330AF	7314150137503	151
BE65R65120	7314150170012	110	BHV1S0677	7314150167708	139	BT10P3	7314150205639	211	S330L	7314150256587	152
BE65R80120	7314150170029	110	BHV1S0680	7314150167715	139	BT15P5	7314150205837	138	S380	7314150168934	152
BE66152A	7314150492534	107	BHV1S0685	7314150167722	139	BT15P524	7314150231737	139	S39MH	7314150557301	148
BE6810	7314150237869	103	BHV1S0690	7314150167739	139	BT15P530	7314150231744	139	S400	7314150110553	158
BE6810Z	7314150430765	103	BHV1S0695	7314150167746	139	BT15P532	7314150231751	139	S460	7314150110660	149
BE6FCP	7314150438907	85	BHV1S08100	7314150165711	139	BT15P536	7314150342129	139	S560	7314150122264	158
BE6F108	7314150434572	108	BHV1S08115	7314150165728	139	BT20P26	7314150205820	122	S560MH	7314150547593	159
BE74-55100	7314150169733	87	BHV1S0895	7314150165704	139	BT20P49	7314150385041	120	S910	7314150104000	160
BE74-57125	7314150169511	87	BHV1S109BPW12	7314150165759	139	BUCPE	7314150243259	58	S9TORX	7314150412440	155
BE74-57125L	7314150169535	87	BHV1S11BPW12	7314150165735	140	BUCPE3SDH	7314150302483	58	SL24	7314150128389	147
BE74-80120	7314150169740	87	BHV1S12BPW16	7314150165742	139	BUCPE3SH	7314150243471	58	SL25	73141503013422	147
BE74-90175	7314150169528	87	BHV1S1265	7314150167685	139	BWB14	7314150170166	120	SL25L	7314150256570	147
BE76101	7314150240005	81	BHV1S80BPW12	7314150165766	140	BWC1	7314150365586	124	SL34	7314150409181	153
BE762	7314150384983	81	BHV1S95BPW9	7314150243334	140	BWHEPSSH8	7314150264896	122	SL65	7314150444137	150
BE800P12	7314150205677	86	BLBT100	7314150179015	59	BWHPJ12	7314150403257	121	SLX 17	73141503015785	160
BE-9588	7314150123810	193	BLE300	7314150227648	59	BWP150	7314150170159	114	SLX 17AF	7314150137558	161
BE-9678	7314150123827	193	BLE301	7314150227662	60	BWSS12P3	7314150170128	138	SLX20	7314150548989	161
BE-9785	7314150056347	193	BLE302	7314150227679	60	BWSS12P5	7314150170135	138	TAWM12340	7314150274925	170
BE-9787	7314150056569	194	BLE304	7314150249572	60	BWTB12P100	7314150329830	140	TAWM34800	7314150274932	170
BELM120BDL	7314150340323	94	BLE305	7314150339341	74	BWTB12P110	7314150329847	140	TAWM38135	7314150274918	170
BELS12	7314150170579	99	BLT550	7314150243556	78	BWTB12P120	7314150329854	140	TAWMB14340	7314150489626	170
BH1100008	7314150516414	45	BMD150	7314150242238	76	BWTB12P135	7314150329861	140	TAWMB24650	7314150490103	170
BH12000	7314150178803	45	BMMTRMS1	7314150274024	96	BWTB12P150	7314150329878	140	TAWMB24800	7314150489633	170
BH13000	7314150178810	44	BMR240	7314150242245	76	BWTB12P160	7314150329885	140	TAWMB9135M	7314150490110	169
BH150008	7314150516407	45	BMTA1000	7314150488360	97	BWTB12P175	7314150329892	140	TAWMB930M	7314150489640	169
BH1A1500A	7314150460946	46	BOD1016	7314150169979	103	BWTB12P190	7314150329908	140	TSS600	7314150346417	166
BH1A2500A	7314150460953	46	BOD10P64	7314150205950	104	BWTB12P200	7314150329915	140	XLARGE	7314150437412	16
BH1CD680	7314150330379	53	BOD2008	7314150169986	103	BWTB12P215	7314150329921	112	XXL	7314150504152	18
BH1CD680ST	7314150330386	53	BOD2F5	7314150351879	105	BWTB12P290	7314150329823	140			
BH1EU3000	7314150245000	44	BOD301200	7314150169993	106	BWTDG1	7314150403400	112			
BH1S45	7314150292295	48	BOD4200	7314150169946	104	BWTPMSS4C	7314150347100	113			
BH230	7314150264070	47	BOD4500	7314150169443	104	BWTPMSS9	7314150347124	114			
BH23015	7314150178759	46	BOD5400	7314150169450	105						

