



CACCIAVITE

catalogo



BAHCO

Indice



ERGO™

2

Cacciavite ERGO™	2
Cacciavite ERGO™ con lame intercambiabili	20
Cacciavite ERGO™ con lama passante.....	22
Cacciavite ERGO™ isolati con lama sottile.....	32
Cacciavite ERGO™ isolati.....	36
Cacciavite ERGO™ acciaio inossidabile.....	40
Cacciavite ERGO™ antiscintilla	46
Cacciavite ERGO™ anticaduta	50



BAHCOFIT

54



SERIE 600

68



A CRICCHETTO

74



PRECISIONE

82



MANICO A T

88



CHIAVI ESAGONALI

94



ALTRI

106







Cacciavite ERGO™

Il processo Bahco ERGO™

Per essere ergonomici, gli utensili manuali devono essere adatti al compito, all'utilizzatore e all'ambiente. Ecco perché tutti e tre questi fattori sono fondamentali quando si crea un prodotto ERGO™.

Gli utensili ergonomici sono progettati per adattarsi alla mano, riducendo al minimo la forza di presa e permettendo ai muscoli di rilassarsi periodicamente, riducendo il rischio di affaticamento muscolare statico.

Ogni volta che si sviluppa un utensile ERGO™, si tiene conto dell'efficienza e dell'efficacia sostenibile, oltre che dell'affidabilità e della durata in ambienti difficili.

Lavoriamo costantemente per offrire i migliori utensili possibili a ogni utilizzatore e nel corso degli anni abbiamo continuamente sviluppato, migliorato e perfezionato il modo in cui lo facciamo, dando vita al **Processo Bahco ERGO™**. Si tratta di un processo completo in tre fasi (ogni fase comprende diversi passaggi) che garantisce la validità degli utensili ERGO™.

Il Processo **Processo Bahco ERGO™** è unico nel suo genere ed è stato realizzato scientificamente con l'aiuto di designer industriali ed ergonomi.

Il **Processo Bahco ERGO™** è conforme alla norma ISO 9241.

I PRODOTTI BAHCO ERGO™ VENGONO CONTINUAMENTE PREMIATI CON I PIÙ PRESTIGIOSI PREMI DI DESIGN

I prodotti Bahco ERGO™ sono stati inclusi in documenti di ricerca e casi aziendali. Collaboriamo inoltre attivamente con università e centri di ricerca di tutto il mondo per la creazione dei nostri prodotti:

- **Effetti sul comfort del design partecipativo dei cacciavite** TU Delft Olanda
- **Successo attraverso il design - Caso aziendale** di Triad Design e Harvard University*
- **Caso aziendale: AB SANDVIK SAWS AND TOOLS: LA STRATEGIA ERGO** University of Western Ontario
- **Master in ricerca sul design presso UFSC** Università Federale di Santa Catarina - Brasile
- **Ergonomia** - Universidad de Navarra, Spagna
- **'Ergonomia per il design'** - Lezione al Politecnico di Milano
- **Design scandinavo** - Taschen



Premio per il design svedese eccellente:

La Svensk Form/Società Svedese di Artigianato e Design verifica e diffonde la conoscenza del migliore design svedese.



Premio Reddot: Con una storia di oltre 50 anni, il "Reddot Award: product design" è uno dei più importanti concorsi internazionali di prodotto.



Premio giapponese per il miglior design: Dal 1957, il Good Design Award viene assegnato a progetti eccellenti da oltre 50 anni.



L'impugnatura

Il diametro dell'impugnatura è ottimizzato per trasmettere la massima coppia e aumentare la produttività. Impugnatura doppia per forze molto elevate, quando sono necessarie entrambe le mani.

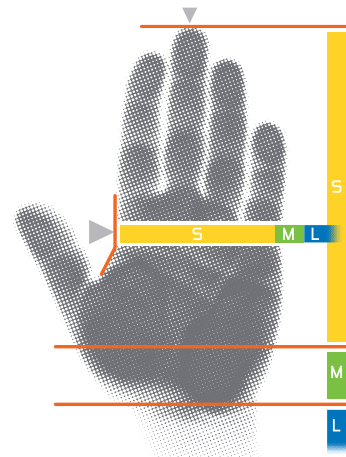

Non crediamo nella esistenza di una dimensione "media"; per questo analizziamo i database antropometrici per definire le dimensioni delle impugnature dei nostri cacciavite.

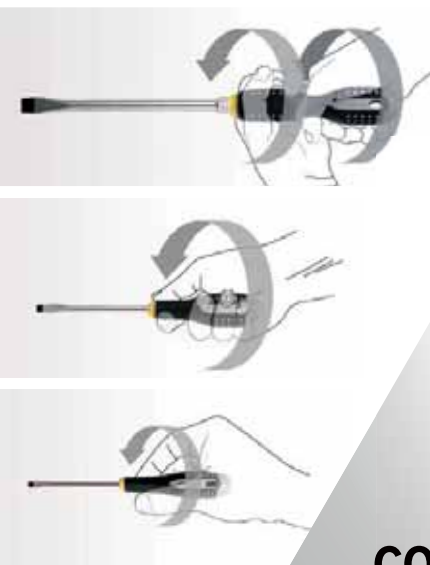

UTILIZZATORE



SICUREZZA
PIACERE
SODDIFAZIONE
SENSIBILITÀ
ORGOGGIO

ergo®

ISPIRATO DAI
PROFESSIONISTI

COMPITO



PRODUTTIVITÀ
E REDDITIVITÀ
PRESTAZIONI DI QUALITÀ



AMBIENTE

DURATA
INNOVAZIONE

Il codice colore

Il codice colore è associato ai processi cognitivi legati all'identificazione del cacciavite giusto. Invece di dover controllare ogni punta, puoi capire rapidamente qual è quella giusta semplicemente in base al colore.

La lama

La lama è realizzata in acciaio legato ad alte prestazioni per la massima durata. È nichel-cromata per la massima resistenza alla corrosione.



Il cacciavite ERGO™ è stato sviluppato attraverso il nostro processo Bahco ERGO™ in tre fasi. Questo programma tiene conto di fatti ed esperienze di utilizzatori, ergonomi, designer industriali e dipartimenti di ricerca e sviluppo, oltre che di test e prove approfondite.

È più facile da usare, più comodo da tenere in mano e decisamente più funzionale. Riduce la tensione muscolare e il rischio di incidenti e lesioni, aumentando la soddisfazione sul lavoro, la produttività e la redditività.

GLI STRUMENTI ERGO™ INIZIANO LA LORO VITA CON UNA SERIE DI QUESTIONARI RIVOLTI AGLI UTILIZZATORI FINALI CONSIDERANDO LE LORO ESPERIENZE CON GLI UTENSILI E SU COME VORREBBERO MIGLIORARLI.

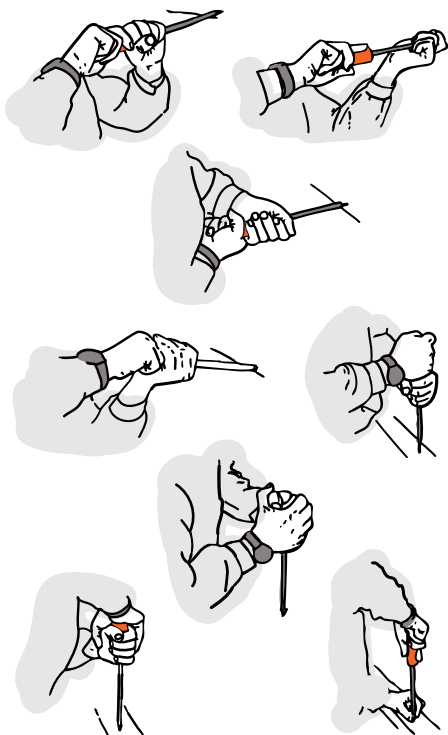

QUESTE INFORMAZIONI VENGONO POI ABBINATE ALLA DOCUMENTAZIONE CHE MOSTRA COME L'UTENSILE VIENE UTILIZZATO NELLE NORMALI SITUAZIONI DI LAVORO.

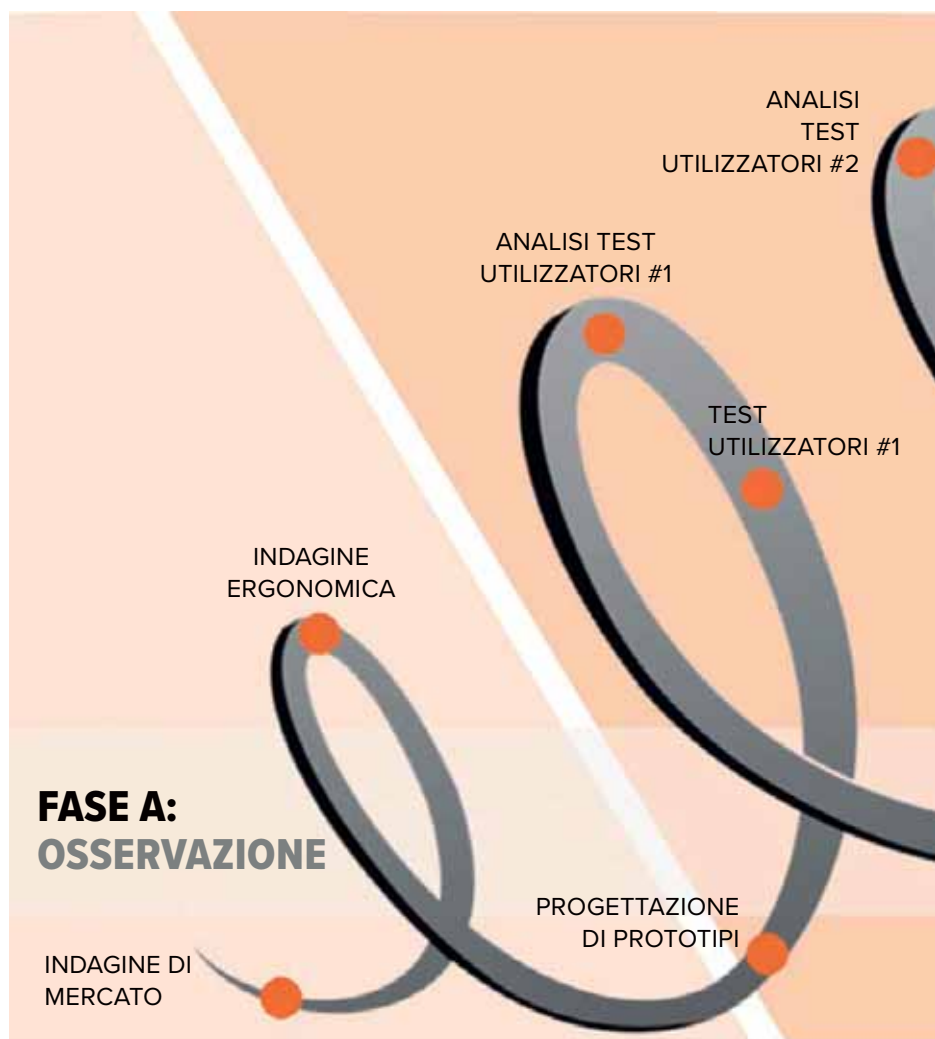

● NUOVA SERIE DI PROTOTIPI

Abbiamo provato diversi diametri di impugnatura con diversi utilizzatori finali per capire cosa si adatta meglio alla mano umana.



**OSSERVIAMO I PROFESSIONISTI
NEL LORO LUOGO DI LAVORO
PER CAPIRE COME UTILIZZANO
GLI UTENSILI**

Bahco è un'azienda all'avanguardia nella progettazione di utensili manuali e nell'ergonomia. Progettiamo utensili manuali dal 1856 e facciamo ricerca nel campo dell'ergonomia dal 1978.

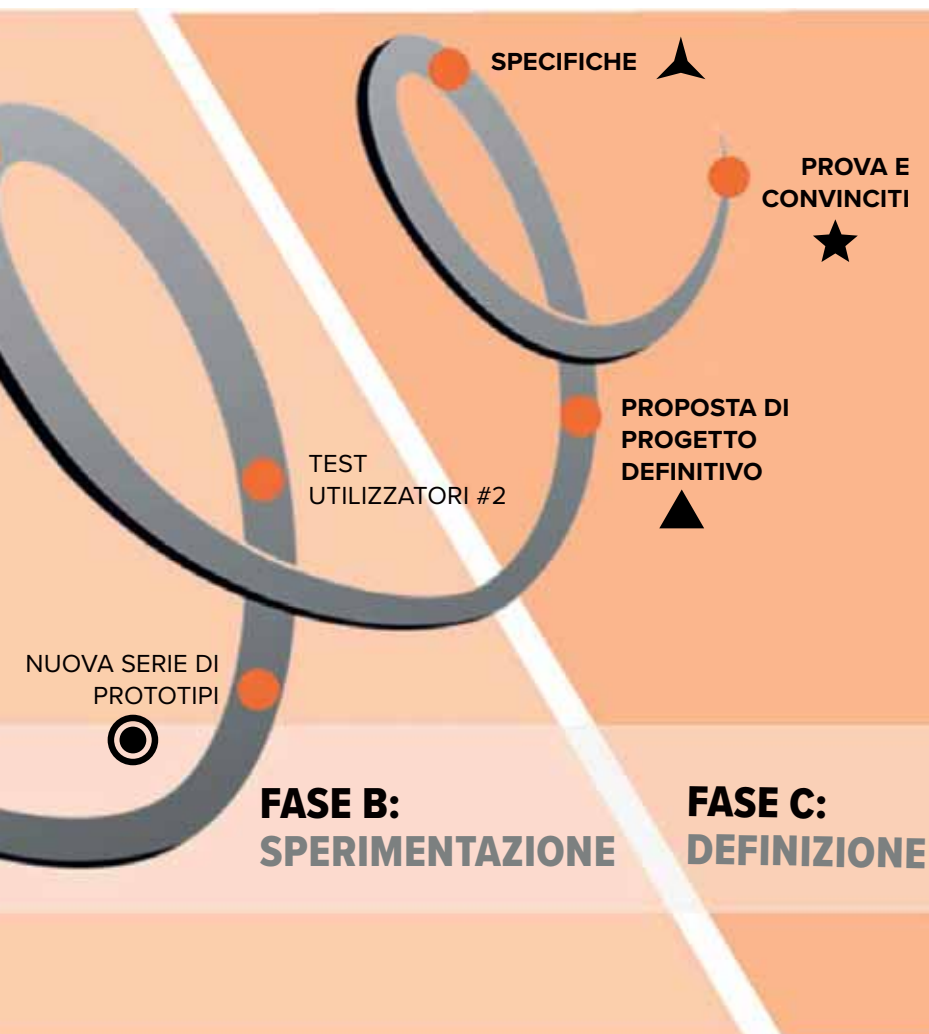

▲ SPECIFICHE

Gli utensili Bahco ERGO™ sono realizzati con le tecnologie più avanzate. Come produttori, rispettiamo i più alti standard di qualità.

★ PROVA E CONVINCITI

In Bahco siamo assolutamente convinti della superiorità degli utensili ERGO™. Per questo motivo sviluppiamo sempre un'unità di prova per ogni utensile ERGO™ in modo che gli utilizzatori professionali possano sentire la differenza.



▲ PROPOSTA DI PROGETTO DEFINITIVO



Scegliere la giusta punta

IL CACCIAVITE PIÙ PERFORMANTE AL MONDO

Precisione della punta: la precisione della punta aumenta la durata del cacciavite ed evita di danneggiare il pezzo.

Trasmissione della coppia: il cacciavite trasmette la coppia e richiede meno forza per svolgere il lavoro.

Test di ossidazione: una minore ossidazione migliora la durata e le prestazioni del cacciavite.

Forza della punta: una punta robusta garantisce la precisione della punta per tutta la sua durata.

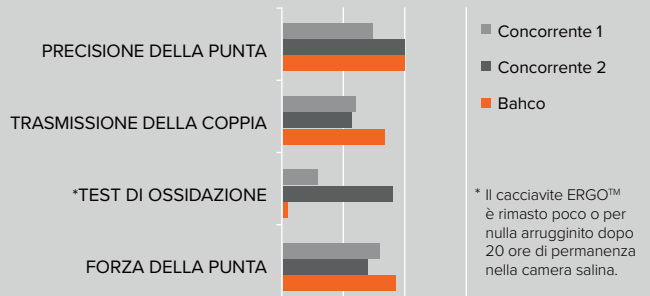

Molto più che un semplice aspetto estetico

- Estremità larga e arrotondata per applicare la forza senza ferire il palmo della mano
- Può essere appeso
- Faccia piatta per evitare che il cacciavite rotoli
- Materiale morbido e ad alto attrito con superficie rigata per una presa confortevole e la massima aderenza anche quando la mano è grassa
- Solo forme arrotondate. Nessun punto di pressione per evitare lesioni e affaticamento
- Lunghezza ottimale dell'impugnatura. Le dita sono sempre posizionate correttamente per una rotazione rapida e un controllo preciso
- Il impugnatura a 3 componenti combina un'anima forte con una ottima presa
- Lo stelo cilindrico con diametro ridotto aiuta a stringere e allentare le viti in modo rapido e semplice
- Facile scelta della punta giusta grazie all'impugnatura con codice colore e al simbolo sull'estremità. Il colore e il simbolo non si consumano
- Codolo esagonale (se presente) per applicare una coppia supplementare con l'uso di una chiave *Dipende dal modello
- Lama in acciaio legato ad alte prestazioni
- La punta nera garantisce un'aderenza precisa

SENZA DUBBIO, IL MIGLIOR CACCIAVITE DEL MONDO

Scegliere il codice colore giusto

**AGGIORNAMO CONTINUAMENTE
LA GAMMA IN BASE ALLE RICHIESTE
DEL MERCATO**

Bahco collabora costantemente con gli utilizzatori finali e gli esperti. Essendo vicina agli utilizzatori finali più esigenti, Bahco anticipa i cambiamenti nelle applicazioni utilizzate in tutti i settori. Per continuare a fornire le migliori soluzioni, Bahco sviluppa continuamente l'assortimento di cacciavite per soddisfare le richieste del mercato.



**È FACILE TROVARE LA PUNTA GIUSTA GRAZIE
AL DOPPIO CODICE COLORE CHE NON SI USURA**

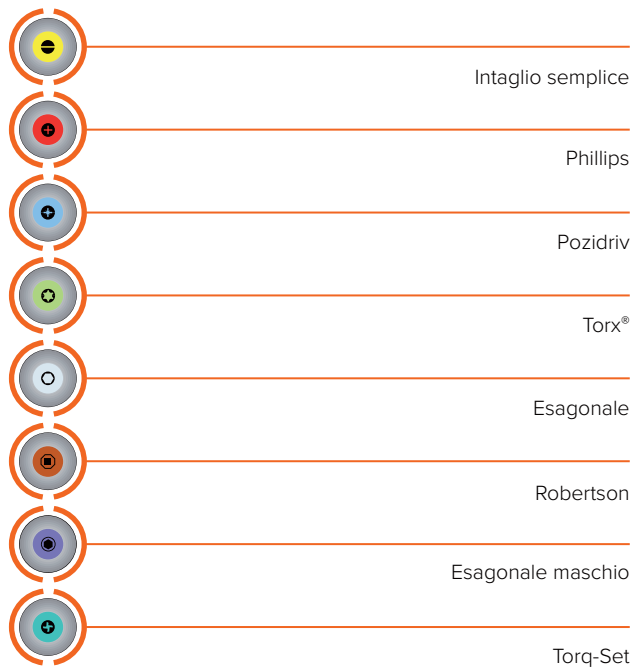

Dimensioni impugnature



**COPPIA E CONTROLLO IN
PERFETTO EQUILIBRIO**



La sua forma, le sue dimensioni e il suo tocco sono stati progettati, ampiamente testati e sviluppati, seguendo un processo scientifico, per dare ai cacciavite ERGO™ un equilibrio ottimale tra coppia (forza di torsione) e controllo. Poiché ogni situazione richiede un approccio diverso, la gamma di cacciavite ERGO™ offre una serie di sei misure di

impugnatura per migliorare la produttività in ogni momento. Ad esempio, i manici a doppia forma per le attività in cui è necessario utilizzare entrambe le mani per ottenere la coppia extra o l'impugnatura extra piccola quando il controllo e la precisione sono fondamentali.

Intaglio semplice

Diritto



BE-8002	0.3	2.0	60	17x103	5	30
BE-8010	0.4	2.5	60	17x103	5	31
BE-8210	0.4	2.5	75	17x103	5	33
BE-8020	0.5	3.0	60	17x103	5	30
BE-8020L	0.5	3.0	75	17x103	5	33
BE-8022	0.5	3.0	100	17x103	5	34
BE-8220	0.5	3.0	125	17x103	5	36
BE-8225	0.5	3.0	200	17x103	5	45
BE-8030	0.6	3.5	75	17x103	5	34
BE-8235	0.6	3.5	200	17x103	5	45
BE-8230	0.6	3.5	125	17x103	5	37
BE-8040	0.8	4.0	100	20x122	5	39
BE-8240	0.8	4.0	175	20x122	5	47
BE-8242	1.0	5.5	150	27x122	5	47
BE-8250L	1.0	5.5	200	27x122	5	90
BE-8241	1.0	5.5	125	27x122	5	47
BE-8251	1.0	6.0	150	36x122	5	44
BE-8252	1.2	6.5	150	36x122	5	47

Piatto



BE-8150	1.0	5.5	100	27x122	5	66
BE-8250	1.0	5.5	150	27x122	5	112
BE-8155	1.2	6.5	125	36x122	5	73
BE-8255	1.2	6.5	150	36x122	5	116
BE-8256	1.6	8.0	150	36x122	5	135
BE-8257	1.6	8.0	175	36x122	5	140
BE-8258	1.6	10.0	200	36x165	5	195

Extra corto



BE-8330	0.6	3.5	25	36x58	5	37
BE-8340	0.8	4.0	25	36x58	5	38
BE-8350	1.0	5.5	25	36x58	5	40
BE-8450	1.0	5.5	45	36x58	5	44
BE-8355	1.2	6.5	25	36x58	5	43
BE-8455	1.2	6.5	45	36x58	5	48
BE-8360	1.2	8.0	25	36x58	5	44

QUAL È LA DIFFERENZA TRA DIRITTO E PIATTO??

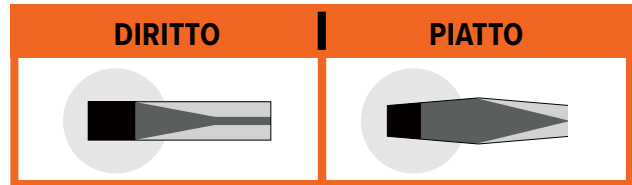

Profilo esagonale



BE-8158	1.0	5.5	125	27x122	9	5	75
BE-8159	1.2	6.5	150	36x122	11	5	125
BE-8160	1.6	8	125	36x122	14	5	162
BE-8260	1.6	8	175	36x122	14	5	179

Profilo esagonale, impugnatura doppia



BE-8865	1.6	8	175	36x165	14	5	209
BE-8870	1.6	10	175	36x165	18	5	210
BE-8880	2.0	12	200	36x165	18	5	291
BE-8890	2.5	14	200	36x165	18	5	293



IMPUGNATURA DOPPIA

Impugnatura a doppia forma, da usare con entrambe le mani (nelle misure grandi). La superficie più ampia dell'elastomero e il design ergonomico avanzato consentono una presa ottimale e confortevole e la massima potenza di coppia.



Phillips



Modello	Bit	Lunghezza (mm)	Spessore (mm)	Spessore (mm)	Spessore (mm)	Peso (g)
BE-8600	PH 0	60	17x103	5		30
BE-8605	PH 0	100	17x103	5		80
BE-8608	PH 0	200	17x103	5		180
BE-8610	PH 1	75	27x122	5		156
BE-8611	PH 1	75	20x122	5		62
BE-8610L	PH 1	200	27x122	5		62
BE-8620	PH 2	100	36x122	5		81
BE-8621	PH 2	100	27x122	5		106
BE-8622	PH 2	150	36x122	5		106
BE-8620L	PH 2	200	36x122	5		127
BE-8623	PH 3	150	36x122	5		150

Impugnatura doppia



Modello	Bit	Lunghezza (mm)	Spessore (mm)	Spessore (mm)	Spessore (mm)	Peso (g)
BE-8624	PH 4	200	36x165	5		225

Profilo esagonale



Modello	Bit	Lunghezza (mm)	Spessore (mm)	Spessore (mm)	Spessore (mm)	Peso (g)
BE-8628	PH 1	100	27x122	9	5	72
BE-8629	PH 2	125	36x122	11	5	122
BE-8630	PH 3	150	36x122	14	5	173

Profilo esagonale, impugnatura doppia



Modello	Bit	Lunghezza (mm)	Spessore (mm)	Spessore (mm)	Spessore (mm)	Peso (g)
BE-8640	PH 4	200	36x165	18	5	292

Extra corto



Modello	Bit	Lunghezza (mm)	Spessore (mm)	Spessore (mm)	Spessore (mm)	Peso (g)
BE-8601	PH 1	25	36x58	5		40
BE-8602	PH 2	25	36x58	5		43

CODOLO ESAGONALE

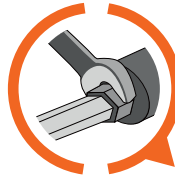

Lo stelo con profilo esagonale e il codolo esagonale consentono di utilizzare una chiave per i lavori più impegnativi che richiedono una coppia di serraggio estremamente elevata.



Pozidriv



Modello	Punta	Lunghezza (mm)	Spessore (mm)	Spessore (mm)	Spessore (mm)	Peso (g)
BE-8800	PZ 0	60	17x103	5		30
BE-8810	PZ 1	75	27x122	5		62
BE-8811	PZ 1	75	20x122	5		62
BE-8810L	PZ 1	200	27x122	5		81
BE-8820	PZ 2	100	36x122	5		106
BE-8821	PZ 2	100	27x122	5		106
BE-8820L	PZ 2	200	36x122	5		127
BE-8823	PZ 3	150	36x122	5		150

Impugnatura doppia



Modello	Punta	Lunghezza (mm)	Spessore (mm)	Spessore (mm)	Spessore (mm)	Peso (g)
BE-8824	PZ 4	200	36x165	5		224

Profilo esagonale



Modello	Punta	Lunghezza (mm)	Spessore (mm)	Spessore (mm)	Spessore (mm)	Peso (g)
BE-8828	PZ 1	100	27x122	9	5	72
BE-8829	PZ 2	125	36x122	11	5	122
BE-8830	PZ 3	150	36x122	14	5	173

Profilo esagonale, impugnatura doppia



Modello	Punta	Lunghezza (mm)	Spessore (mm)	Spessore (mm)	Spessore (mm)	Peso (g)
BE-8840	PZ 4	200	36x165	18	5	292

Extra corto



Modello	Punta	Lunghezza (mm)	Spessore (mm)	Spessore (mm)	Spessore (mm)	Peso (g)
BE-8801	PZ 1	25	36x58	5		40
BE-8802	PZ 2	25	36x58	5		43

UTILIZZA LA COMBINAZIONE CORRETTA

Le conseguenze principali dell'utilizzo di una punta sbagliata sono tre:

- 1 Non viene applicata la coppia necessaria
- 2 Aumenta il rischio di rottura della punta del cacciavite
- 3 Il pezzo da lavorare può essere danneggiato

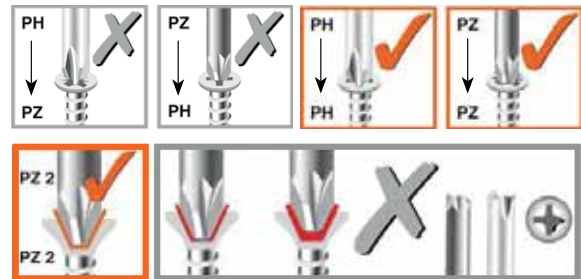

PUNTA NERA = MAGGIORE PRECISIONE

Punta con finitura nera.

È un processo di ossidazione che non aggiunge alcuno strato, quindi la punta è più precisa.

Usa la punta con finitura nera per ottenere una maggiore precisione.

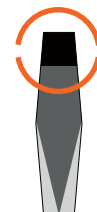



Icona	Modello	Spessore (mm)	Spessore (mm)	Lunghezza (mm)	Capacità	Peso (g)	
	BE-8904	T 4	1.30	75	17x103	5	30
	BE-8905	T 5	1.37	75	17x103	5	30
	BE-8906	T 6	1.65	75	17x103	5	30
	BE-8907	T 7	1.97	75	17x103	5	30
	BE-8908	T 8	2.30	75	17x103	5	32
	BE-8909	T 9	2.48	75	17x103	5	33
	BE-8910	T 10	2.72	75	20x122	5	31
	BE-8915	T 15	3.26	100	27x122	5	57
	BE-8920	T 20	3.84	100	27x122	5	57
	BE-8925	T 25	4.40	125	27x122	5	70
	BE-8927	T 27	4.96	125	27x122	5	70
	BE-8930	T 30	5.49	150	36x122	5	119

Impugnatura doppia



Icona	Modello	Spessore (mm)	Spessore (mm)	Lunghezza (mm)	Capacità	Peso (g)	
	BE-8940	T 40	6.60	150	36x165	5	130
	BE-8945	T 45	7.70	150	36x165	5	178

TORX® Tamper resistant



Icona	Modello	Spessore (mm)	Spessore (mm)	Lunghezza (mm)	Capacità	Peso (g)	
	BE-7907	TR 7	1.97	75	17x103	5	31
	BE-7908	TR 8	2.30	75	17x103	5	31
	BE-7909	TR 9	2.48	75	17x103	5	31
	BE-7910	TR 10	2.72	75	20x122	5	31
	BE-7915	TR 15	3.26	100	27x122	5	57
	BE-7920	TR 20	3.84	100	27x122	5	57
	BE-7925	TR 25	4.40	125	27x122	5	70
	BE-7927	TR 27	4.96	125	27x122	5	70
	BE-7930	TR 30	5.49	150	36x122	5	119

TORX® Tamper resistant impugnatura doppia



Icona	Modello	Spessore (mm)	Spessore (mm)	Lunghezza (mm)	Capacità	Peso (g)	
	BE-7940	TR 40	6.60	150	36x165	5	130

TORX® TAMPER RESISTANT

Le viti TORX®, resistenti alle manomissioni, contengono un perno al centro della testa che impedisce l'inserimento di un cacciavite TORX® «standard», il che significa che le viti di sicurezza non possono essere svitare senza il corretto cacciavite.



TORX® testa sferica



Icona	Modello	Spessore (mm)	Spessore (mm)	Lunghezza (mm)	Capacità	Peso (g)	
	BE-7515	T 15	3.26	100	27x122	5	57
	BE-7520	T 20	3.84	100	27x100	5	57
	BE-7525	T 25	4.40	125	27x122	5	70
	BE-7527	T 27	4.96	125	27x122	5	70
	BE-7530	T 30	5.49	150	36x122	5	119
	BE-7540	T 40	6.60	150	36x122	5	119

TORX® TESTA SFERICA

Il profilo di guida sferico consente di lavorare con un'angolazione fino a 30° con la massima efficacia. Le punte TORX® a testa sferica sono necessarie per avvitare in punti stretti o angolati.



TORX PLUS®



Icona	Modello	Spessore (mm)	Spessore (mm)	Lunghezza (mm)	Capacità	Peso (g)	
	BE-7715	T 15	3,26	100	27x122	5	57
	BE-7720	T 20	3,84	100	27x100	5	57
	BE-7725	T 25	4,40	125	27x122	5	70
	BE-7727	T 27	4,96	125	27x122	5	70
	BE-7730	T 30	5,49	150	36x122	5	119
	BE-7740	T 40	6,60	150	36x122	5	119

TORX PLUS®

TORX PLUS® è stato progettato per consentire una coppia maggiore, minimizzare l'usura e aumentare la produttività riducendo i tempi di inattività. Grazie a un'area di contatto più ampia rispetto al profilo TORX® standard, la quantità di trasmissione aumenta, così come la durata degli utensili.



TORX® contro TORX PLUS®



Esagonale



	mm	mm	mm		g
BE-6902	2	100	17x103	5	32
BE-6925	2.5	100	17x103	5	32
BE-6903	3	100	20x122	5	35

Esagonale testa sferica



	mm	mm	mm		g
BE-8715	1.5	60	17x103	5	30
BE-8702	2	100	17x103	5	32
BE-8725	2.5	100	17x103	5	32
BE-8703	3	100	20x122	5	35
BE-8704	4	100	27x122	5	66
BE-8705	5	100	36x122	5	105
BE-8706	6	125	36x122	5	125
BE-8708	8	150	36x122	5	197

Esagonale testa sferica impugnatura doppia



	mm	mm	mm		g
BE-8710	10	150	36x165	5	250

Esagonale testa sferica in pollici



	"	mm	mm		g
BE-8700-7/64	7/64"	100	20x122	5	35
BE-8700-5/32	5/32"	100	27x122	5	66
BE-8700-3/16	3/16"	100	27x122	5	105
BE-8700-7/32	7/32"	100	36x122	5	110
BE-8700-1/4	1/4"	125	36x122	5	126
BE-8700-5/16	5/16"	150	36x122	5	197

Esagonale testa sferica impugnatura doppia



	"	mm	mm		g
BE-8700-3/8	3/8"	150	36x165	5	250

ESAGONALE TESTA SFERICA

Cacciavite per vite esagonale, con estremità sferica, facile da inserire nella testa della vite da una serie di angolazioni, fino a 30°, per un accesso migliore rispetto alla punta esagonale standard.

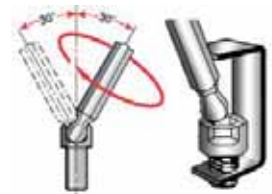

Robertson



		mm	mm		g
BE-9001	# 1	80	27x122	1	62
BE-9002	# 2	80	27x122	5	62
BE-9003	# 3	100	27x122	5	105



Torq-Set



BE-8080-1	1	75	27x122	5	58	
BE-8080-2	2	75	27x122	5	58	
BE-8080-3	3	75	27x122	5	58	
BE-8080-4	4	75	27x122	5	58	
BE-8080-5	5	75	27x122	5	58	
BE-8080-6	6	75	27x122	5	58	
BE-8080-8	8	100	27x122	5	75	
BE-8080-10	10	100	27x122	5	75	



Triwing



BE-9100	0	80	20x122	5	34	
BE-9101	1	80	20x122	5	34	
BE-9102	2	80	27x122	5	62	
BE-9103	3	80	27x202	5	62	
BE-9104	4	100	27x122	5	75	
BE-9105	5	100	27x122	5	75	



Punteruolo

Punta tonda



BE-8985	6.0	100	27x122	5	67	

Extra corto



BE-8986	6	25	36x58	5	40	

Alesatore

Punta quadrata



BE-8980	6.0	100	27x122	5	5.5	

Vite esagonale maschia

Bussola corta



BE-6400M-4	4	23x5.9	100	20x122	5	36
BE-6400M-5	5	23x6.95	100	20x122	5	38
BE-6400M-5,5	5.5	23x7.65	100	20x122	5	38
BE-6400M-7	7	23x9.8	100	20x122	5	42

Bussola lunga



BE-7803	3	50x6	125	20x122	5	52
BE-7835	3.5	50x6	125	20x122	5	54
BE-7804	4	60x7	125	20x122	5	57
BE-7845	4.5	60x7	125	20x122	5	58
BE-7805	5	60x8	125	20x122	5	60
BE-7855	5.5	60x8.7	125	20x122	5	62
BE-7806	6	60x9.5	125	20x122	5	64
BE-7807	7	60x11	125	27x122	5	100
BE-7808	8	60x12	125	27x122	5	104
BE-7809	9	60x14	125	36x122	5	136
BE-7810	10	60x10	125	36x122	5	140
BE-7811	11	60x16	125	36x122	5	169
BE-7812	12	60x17	125	36x122	5	184

Impugnatura doppia bussola lunga



BE-7813	13	60x18	125	36x165	5	215
BE-7814	14	60x20	125	36x165	5	230

Lama flessibile



BE-7606	6	11x27	150	27x122	5	126
BE-7607	7	11x27	150	27x122	5	126
BE-7608	8	11x27	150	27x122	5	126

Bussola corta



Bussola lunga



Lama flessibile

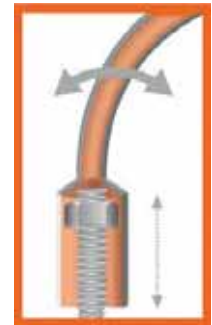
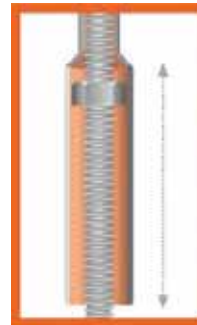
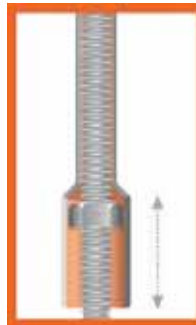

MAGNETE PERMANENTE

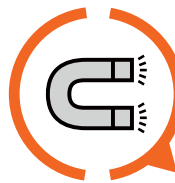

Il portainseri ERGO™ con un forte magnete permanente trattiene perfettamente l'inserto.

Portainseri



BE-8577	1/4"	9.5x24	118	36x122	5	5.5



Assortimenti cacciavite ERGO™



Assortimento 5 pezzi

BE-9885	1	355
BE-8910, BE-8915, BE-8920, BE-8925 T10x75, T15x100, T20x100, T25x125, T30x150		



Assortimento 6 pezzi

BE-9871	1	450
BE-8220S 0.5x3x100, isolato		
BE-8611, BE-8621 PH1x75, PH2x100		
BE-8820 PZ2x100		
BE-8920, BE-8925 T20x100, T25x125		



Assortimento 6 pezzi

BE-9881	1	450
BE-8020, BE-8040 0.5x3x60, 0.8x4x100		
BE-8150, BE-8155 1.0x5.5x100, 1.2x6.5x125		
BE-8610, BE-8620 PH1x75, PH2x100		



Assortimento 6 pezzi

BE-9882	1	400
BE-8020, BE-8040 0.5x3x60, 0.8x4x100		
BE-8150, BE-8155 1.0x5.5x100, 1.2x6.5x125		
BE-8810, BE-8820 PZ1x75, PZ2x100		



Assortimento 6 pezzi

BE-9884	1	450
BE-8040, BE-8241 0.8x4x100, 1.0x5.5x125		
BE-8611, BE-8621 PH1x75, PH2x100		
BE-8811, BE-8821 PZ1x75, PZ2x100		



Assortimento 6 pezzi

BE-9886	1	430
BE-8030 0.6x3.5x75		
BE-8150 1x5.5x100		
BE-8611, BE-8621 PH1x75, PH2x100		
BE-8811, BE-8821 PZ1x75, PZ2x100		



Assortimento **8** pezzi

		📦	📄
BE-9872		1	595
BE-8030 0.6x3.5x75	⓪		
BE-8611, BE-8621 PH1x75, PH2x100	⊕		
BE-8811, BE-8821 PZ1x75, PZ2x100	⊗		
BE-8915, BE-8920, BE-8925 T15x100, T20x100, T25x125	⊛		



Assortimento **13** pezzi

		📦	📄
BE-9875		1	975
BE-8040 0.8x4x100	⓪		
BE-8150, BE-8155 1.0x5.5x100, 1.2x6.5x125	⓪		
BE-8621 PH2x100	⊕		
BE-8811, BE-8821 PZ1x75, PZ2x100	⊗		
BE-8910, BE-8915, BE-8920, BE-8925 T10x75, T15x100, T20x100, T25x125	⊛		
BE-8010S, BE-8230S 0.4x2.5x75, 0.6x3.5x100 isolati	⓪		
BE-8810S PZ1x80, isolato	⊗		



Assortimento **13** pezzi

		📦	📄
BE-9879		1	975
BE-8010, BE-8040, BE-8150 0.4x2.5x60, 0.8x4x100, 1x5.5x100	⓪		
BE-8611, BE-8621 PH1x75, PH2x100	⊕		
BE-8811, BE-8821 PZ1x75, PZ2x100	⊗		
BE-8910, BE-8915, BE-8920, BE-8925 T10x75, T15x100, T20x100, T25x125	⊛		
BE-8220SL 0.5x3x100, isolato lama sottile	⓪		
BE-8620SL PH1x80, isolato lama sottile	⊕		



Assortimento **15** pezzi

		📦	📄
BE-9877		1	1100
BE-8030 0.6x3.5x75	⓪		
BE-8150 1x5.5x100	⓪		
BE-8611, BE-8621 PH1x75, PH2x100	⊕		
BE-8811, BE-8821 PZ1x75, PZ2x100	⊗		
BE-8910, BE-8915, BE-8920, BE-8925 T10x75, T15x100, T20x100, T25x125	⊛		
BE-8220S, BE-8040S, BE-8050S 0.5x3x100, 0.8x4x100, 1x5.5x125, isolati	⓪		
BE-8610S, BE-8620S PH1x80, PH2x100, isolati	⊕		



Impugnatura ERGO™ con lame intercambiabili

NON SOLO IL CACCIAVITE PIÙ COMODO, MA ANCHE IL PIÙ UNIVERSALE!

La novità dell'assortimento ERGO™ è il cacciavite con lame intercambiabili, un'impugnatura ERGO™ combinata con un portainserti a sgancio rapido.

L'impugnatura ERGO™ con lame intercambiabili combina il comfort di un cacciavite ERGO™ con la flessibilità di una facile sostituzione delle lame.

Impugnatura ERGO™ a sgancio rapido



Icona	Icona	Icona	Icona	Icona
BE-8575	IMPUGNATURA ERGO™ A SGANCIO RAPIDO	1	100	

Lame di ricambio 100 mm



Icona	Icona	Icona	Icona	Icona
8020-2P	(x2) 1/4" 0.5x3.0	100	1	55
8030-2P	(x2) 1/4" 0.6x3.5	100	1	55
8040-2P	(x2) 1/4" 0.8x4.0	100	1	55
8242-2P	(x2) 1/4" 1x5.5	100	1	55
8252-2P	(x2) 1/4" 1.2x6.5	100	1	55
8600-2P	(x2) 1/4" PH0	100	1	55
8610-2P	(x2) 1/4" PH1	100	1	55
8620-2P	(x2) 1/4" PH2	100	1	55
8630-2P	(x2) 1/4" PH3	100	1	55
8800-2P	(x2) 1/4" PZ0	100	1	55
8810-2P	(x2) 1/4" PZ1	100	1	55
8820-2P	(x2) 1/4" PZ2	100	1	55
8830-2P	(x2) 1/4" PZ3	100	1	55
8910-2P	(x2) 1/4" TORX10	100	1	55
8915-2P	(x2) 1/4" TORX15	100	1	55
8920-2P	(x2) 1/4" TORX20	100	1	55
8925-2P	(x2) 1/4" TORX25	100	1	55
8927-2P	(x2) 1/4" TORX27	100	1	55
8930-2P	(x2) 1/4" TORX30	100	1	55
8940-2P	(x2) 1/4" TORX40	100	1	55
8703-2P	(x2) 1/4" HEX BALL 3	100	1	55
8704-2P	(x2) 1/4" HEX BALL 4	100	1	55
8705-2P	(x2) 1/4" HEX BALL 5	100	1	55
8706-2P	(x2) 1/4" HEX BALL 6	100	1	55



Lame di ricambio 300 mm



Icona	Icona	Icona	Icona	Icona
8040L-2P	(x2) 1/4" 0.8x4	300	1	170
8242L-2P	(x2) 1/4" 1.0x5.5	300	1	170
8252L-2P	(x2) 1/4" 1.2x6.5	300	1	170
8610L-2P	(x2) 1/4" PH1	300	1	170
8620L-2P	(x2) 1/4" PH2	300	1	170
8810L-2P	(x2) 1/4" PZ1	300	1	170
8820L-2P	(x2) 1/4" PZ2	300	1	170
8915L-2P	(x2) 1/4" TORX15	300	1	170
8920L-2P	(x2) 1/4" TORX20	300	1	170
8925L-2P	(x2) 1/4" TORX25	300	1	170
8927L-2P	(x2) 1/4" TORX27	300	1	170
8930L-2P	(x2) 1/4" TORX30	300	1	170

Lame di ricambio 400 mm



Icona	Icona	Icona	Icona	Icona
8252XL-1P	(x1) 1/4" 1.2x6.5	400	1	120
8620XL-1P	(x1) 1/4" PH2	400	1	120
8630XL-1P	(x1) 1/4" PH3	400	1	120
8820XL-1P	(x1) 1/4" PZ2	400	1	120
8830XL-1P	(x1) 1/4" PZ3	400	1	120

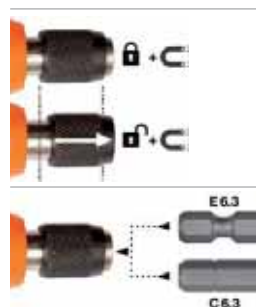

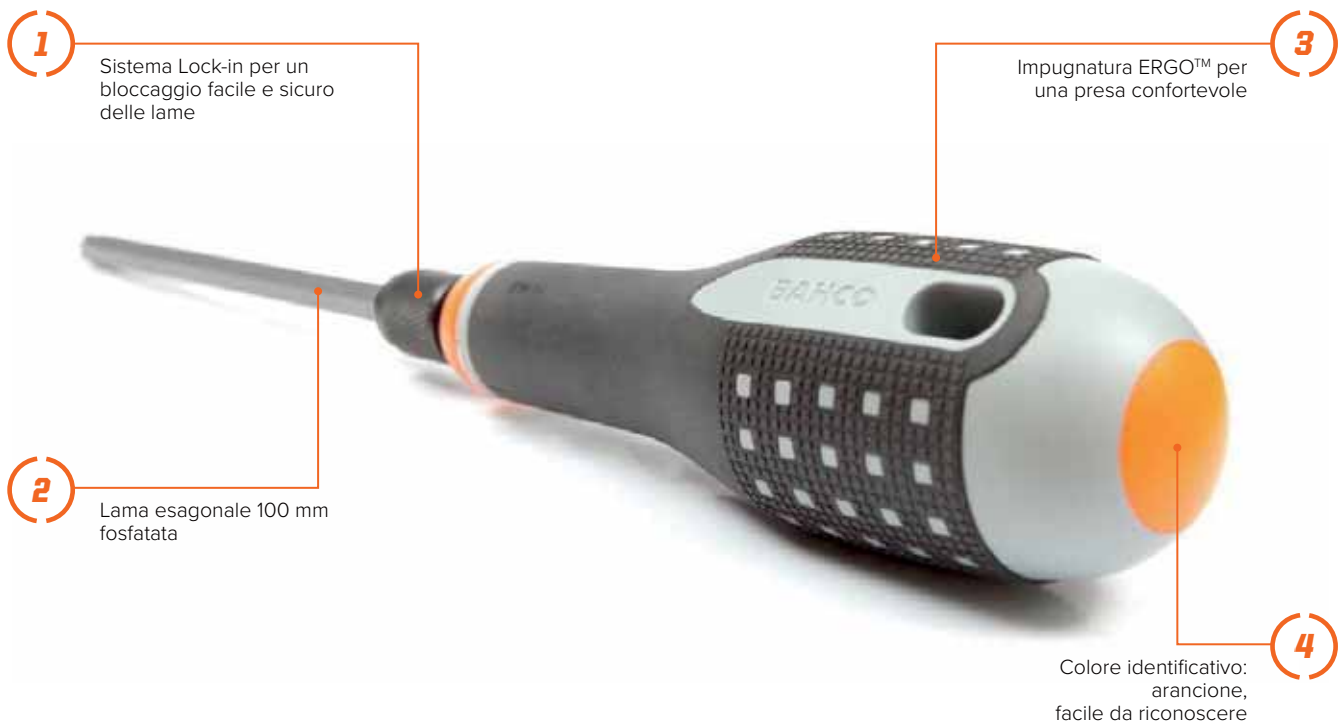

Impugnatura ERGO™ con lame intercambiabili

Icona	Descrizione	Quantità	Prezzo
	Assortimento 7 pezzi, impugnatura ERGO™ con lame intercambiabili: PH1, PH2, PZ1, PZ2, 1x5.5, 1.2x6.5	1	425
	Assortimento 9 pezzi, impugnatura ERGO™ con lame intercambiabili: PH1, PH2, PZ1, PZ2, T10, T15, 1x5.5, 1.2x6.5	1	485
	Assortimento 8 pezzi, impugnatura ERGO™ con lame intercambiabili: T10, T15, T20, T25, T27, T30, T40	1	450
	Assortimento 22 pezzi, impugnatura ERGO™ con lame intercambiabili (16 pezzi): PH1, PH2, PH3, PZ1, PZ2, PZ3, T10, T15, T20, T25, T30, T40, 0.6x3.5, 0.8x4.0, 1.0x5.5, 1.2x6.5 Inserti (6 pezzi): H2,5, H3, H4, H5, H6, H8	1	600
	Assortimento 8 pezzi, impugnatura ERGO™ con lame intercambiabili: PH1, PH2, PZ2, 0.8x40, T20, T25, T30	1	450



Impugnatura ERGO™ con lame intercambiabili

- Lame esagonali 100 mm
- In una custodia di nylon o in termoformato
- Disponibile in 4 set o come ricambi







**Cacciavite ERGO™
con lama passante**

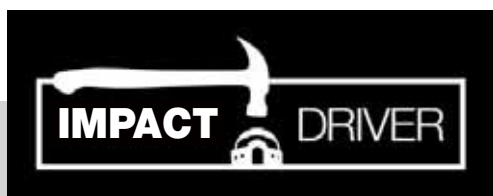

Progettato per **scalpellare, stringere e allentare viti fortemente arrugginite, corrose e grippate**, questo cacciavite trasferisce la forza d'urto direttamente sulla superficie di lavoro.

La **calotta metallica** in cima all'impugnatura offre una protezione aggiuntiva per i lavori che richiedono un impatto elevato e la massima forza.





Il cacciavite con lama passante ERGO™ è in grado di svolgere tutti i lavori più difficili con forza e affidabilità.

Intaglio semplice

Dritto



BE-8135TB		0.6	3.5	75	27x122	–	10	65
BE-8145TB		0.8	4.5	100	27x122	5	10	65
BE-8150TB		1.0	5.5	100	27x122	5	10	75
BE-8155TB		1.2	6.5	125	36x122	6	10	125
BE-8256TB		1.6	8.0	150	36x122	8	10	162
BE-8258TB		1.6	10	175	36x122	8	10	210
BE-8262TB		2.0	12	200	36x122	8	10	291

Phillips



BE-8610TB		PH 1	100	27x122	5	10	72
BE-8620TB		PH 2	125	36x122	6	10	122
BE-8623TB		PH 3	150	36x122	8	10	173
BE-8624TB		PH 4	175	36x122	8	10	292

Pozidriv



BE-8810TB		PZ 1	100	27x122	5	10	72
BE-8820TB		PZ 2	125	36x122	6	10	122
BE-8823TB		PZ 3	150	36x122	8	10	173
BE-8824TB		PZ 4	175	36x122	8	10	292

Torx®



BE-8910TB		T 10	2.72	75	27x122	–	5	65
BE-8915TB		T 15	3.26	100	27x122	5	5	98
BE-8920TB		T 20	3.84	100	27x122	5	5	100
BE-8925TB		T 25	4.40	100	27x122	5	5	102
BE-8927TB		T 27	4.96	125	27x122	5	5	125
BE-8930TB		T 30	5.49	150	36x122	6	5	175
BE-8940TB		T 40	6.60	150	36x122	8	5	232



Assortimenti cacciavite a lama passante ERGO™



Assortimento **5** pezzi



BE-9885TB

1

600

BE-8915TB, BE-8920TB,
BE-8925TB, BE-8930TB,
BE-8940TB
T15x100, T20x100, T25x100,
T30x150, T40x150



Assortimento **6** pezzi



BE-9881TB

1

750

BE-8135TB, BE-8145TB,
BE-8150TB, BE-8155TB
0.6x3.5x75, 0.8x4.5x100,
1x5.5x100, 1.2x6.5x125



BE-8610TB, BE-8620TB
PH1x100, PH2x125



Assortimento **6** pezzi



BE-9882TB

1

750

BE-8135TB, BE-8145TB,
BE-8150TB, BE-8155TB
0.6x3.5x75, 0.8x4.5x100,
1x5.5x100, 1.2x6.5x125



BE-8810TB, BE-8820TB
PZ1x100, PZ2x125

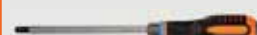

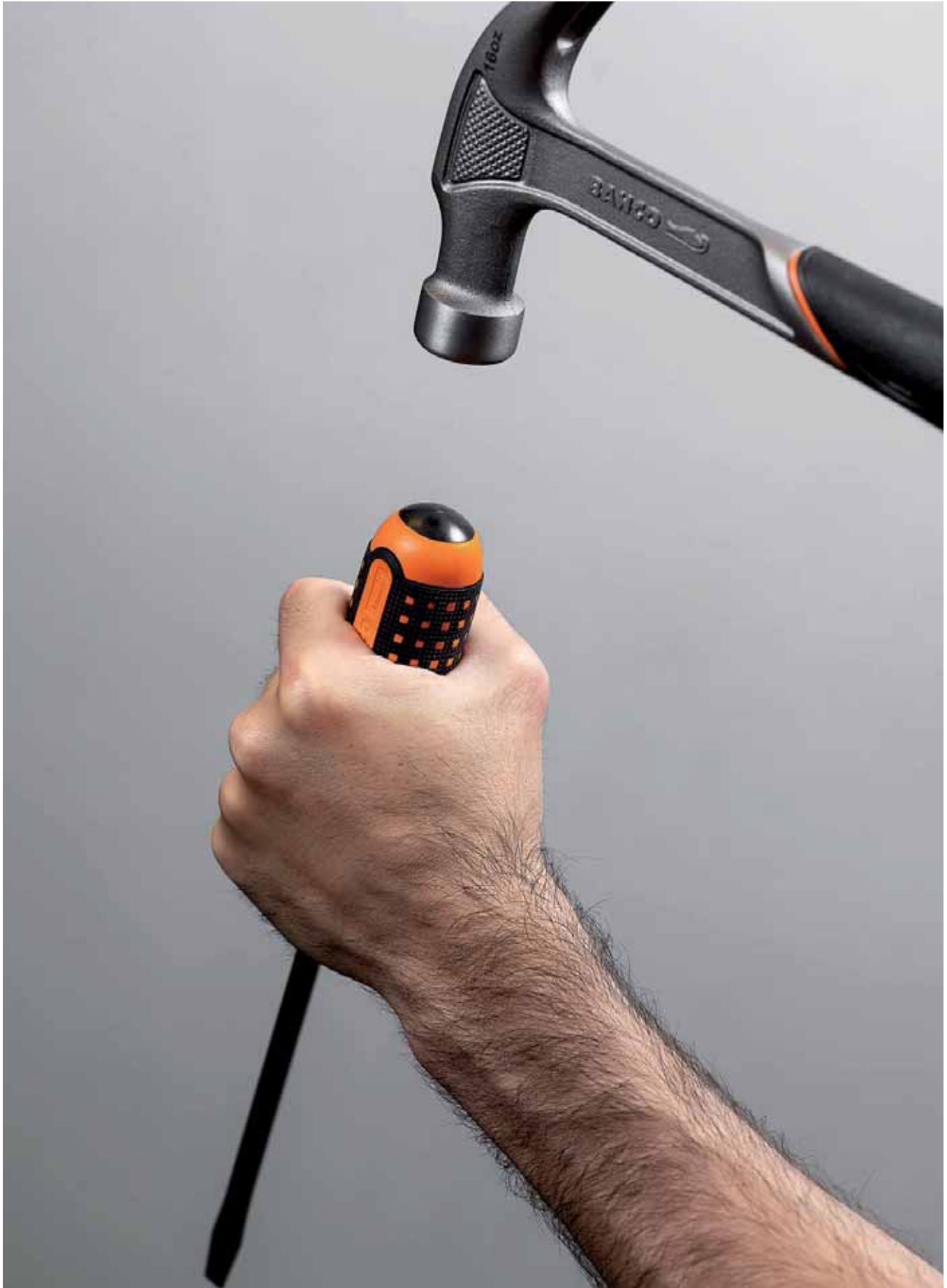





**Cacciavite ERGO™
isolati**

Cacciavite isolati

Per lavorare su apparecchiature sotto tensione fino a 1000 volt, Bahco offre un'ampia gamma di utensili di sicurezza isolati. Tutti gli utensili isolati Bahco sono prodotti secondo lo **standard internazionale IEC60900** per lavorare con **sistemi sotto tensione fino a 1000 V AC e 1500 V DC**.

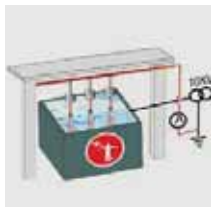

Test dielettrico

Gli utensili vengono immersi in acqua per 24 ore. Viene poi applicata una tensione di 10kV in modo continuo per 3 minuti. Il test si considera superato se non si verificano perforazioni elettriche, scintille o flashover durante il periodo di prova. I limiti di perdita non devono essere superati.



Test della fiamma

Il test è superato quando viene posizionato su un fuoco, dove l'altezza delle fiamme sugli strumenti non supera i 120 mm, e il materiale isolante non si scioglie e non c'è perdita di materiale.

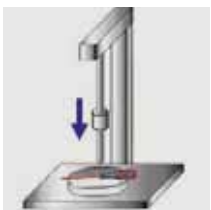

Test d'impatto

Gli utensili vengono raffreddati a -25 °C per 2 ore. Poi, un martello speciale viene utilizzato con una certa forza sullo strato isolante. Il test si considera riuscito se il materiale isolante non presenta rotture e supera il test dielettrico.



Durata della marcatura permanente

Le marcature vengono strofinate per 15 secondi con uno straccio imbevuto di acqua e poi per 15 secondi con uno straccio imbevuto di isopropanolo. Il test è superato se, dopo questo processo, le marcature sono ancora leggibili.



Test di aderenza del materiale isolante

Gli strumenti vengono conservati a una temperatura di 70 °C per 168 ore. Poi viene applicata una forza di 490 N in direzione della linea che divide il materiale isolante dalla parte conduttiva per 3 minuti. Durante questo test il materiale isolante deve rimanere saldamente attaccato agli utensili.



Seguono rigorosi controlli di qualità e tutti gli utensili sono sottoposti ai più severi test individuali. Segui attentamente le istruzioni di sicurezza quando lavori con sistemi sotto tensione.

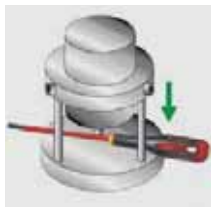

Test di penetrazione

Le superfici isolate degli utensili vengono pressate con un dispositivo speciale. Viene quindi applicata una tensione di 5000 V all'utensile per 3 minuti. Il test si considera superato se non si verificano perforazioni elettriche, scintille o flash-over durante il periodo di prova.



Aspetto visivo e dimensionale

Gli utensili, e in particolare l'isolamento, vengono controllati visivamente e devono essere privi di difetti esterni. Le marcature devono essere perfettamente leggibili e le dimensioni devono essere conformi allo standard.



**CACCIAVITE PER ELETTRICISTI
PER LAVORI SU APPARECCHIATURE
SOTTO TENSIONE,
FINO A 1000 V**

**TUTTI I CACCIAVITE ISOLATI
SONO TESTATI AL 100%
SEGUENDO UN RIGOROSO
CONTROLLO DI QUALITÀ.
I CACCIAVITE BAHCO SONO
UNA GARANZIA DI QUALITÀ E
SICUREZZA.**

**TEST DI ROUTINE IN
CONFORMITÀ ALLE
SPECIFICHE IEC60900**



Cacciavite ERGO™ isolati con lama sottile

L'assortimento di cacciavite Bahco ERGO™ isolati comprende la **linea a lama sottile**.

Le lame normali sono limitate negli spazi ristretti. Le nuove lame "slim" sono più sottili del **30% rispetto alle lame isolate** normali per una migliore accessibilità e consentono agli utilizzatori di accedere a viti incassate in profondità e di azionare morsettiere a molla.

Tutti gli utensili isolati Bahco sono prodotti secondo lo standard internazionale IEC60900 per lavorare con **sistemi sotto tensione fino a 1000 V AC e 1500 V DC**. Tutti i cacciavite isolati sono testati al 100% seguendo un rigoroso controllo di qualità per garantire la qualità e la sicurezza dell'utente.



LAME SOTTILI

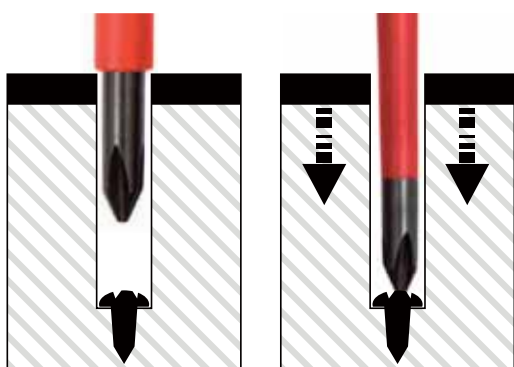

LE LAME SONO PIÙ SOTTILI DEL 30% RISPETTO ALLE NORMALI LAME ISOLATE PER UNA MIGLIORE ACCESSIBILITÀ (AD ESEMPIO VITI INCASSATE ED ELEMENTI A MOLLA)

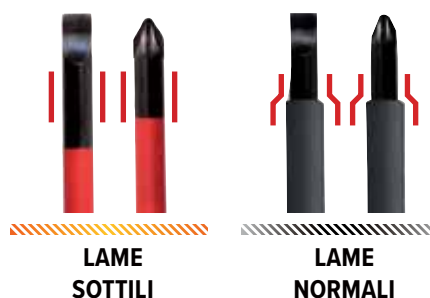

Cacciavite ERGO™ isolati

- Cacciavite sviluppato secondo il processo scientifico ERGO™
- **Per lavorare su apparecchiature sotto tensione, fino a 1000 V**
- Impugnatura a 3 componenti, per il massimo comfort dell'utilizzatore e la massima trasmissione della forza
- Facile scelta della punta giusta, grazie al codice colore dell'impugnatura e al simbolo sull'estremità
- Acciaio legato ad alte prestazioni, isolamento stampato direttamente sulla lama
- Punta con finitura nera per una maggiore precisione
- Ispezionato individualmente e prodotto secondo la norma IEC 60900



1 Ampia estremità arrotondata per applicare la forza senza ferire il palmo della mano

2 Faccia piatta per evitare che il cacciavite rotoli

3 Solo forme rotonde. Non ci sono punti di pressione, indipendentemente dal modo in cui il cacciavite viene utilizzato

4 Lunghezza ottimale dell'impugnatura. Le dita sono sempre posizionate correttamente per una rotazione rapida e un controllo preciso

5 Facile scelta della punta giusta grazie all'impugnatura con codice colore e al simbolo sull'estremità. Il colore e il simbolo non si consumano

6 Lama realizzata in acciaio legato ad alte prestazioni per una maggiore resistenza e affidabilità. Isolamento stampato direttamente sulla lama

7 La punta nera garantisce un'aderenza precisa e non si sfalda

8 Può essere appeso

9 Materiale morbido e ad alto attrito con superficie rigata per una presa confortevole anche quando la mano è unta

10 Il impugnatura a 3 componenti combina un'anima forte con una ottima presa

11 Lo stelo cilindrico di diametro ridotto aiuta a stringere e allentare le viti in modo facile e veloce

ISOLATO

Certificato secondo la
norma IEC 60900

IEC 60900  1000V  

**LE LAME SONO PIÙ
SOTTILI DEL 30%**



Lame isolate sottili

Intaglio semplice



	mm	mm	mm	mm		g
BE-8220SL	0.5	3	100	17x103	5	33
BE-8230SL	0.6	3.5	100	17x103	5	33
BE-8040SL	0.8	4	100	20x122	5	33
BE-8050SL	1.0	5.5	125	27x122	5	62
BE-8255SL	1.2	6.5	150	36x122	5	105

Pozidriv



		mm	mm		g
BE-8810SL	PZ 1	80	20x122	5	64
BE-8820SL	PZ 2	100	27x122	5	110

Phillips



		mm	mm		g
BE-8610SL	PH 1	80	20x122	5	64
BE-8620SL	PH 2	100	27x122	5	108

Torx®



		mm	mm		g	
BE-8910SL	T 10	2.72	100	20x122	5	33
BE-8915SL	T 15	3.26	100	20x122	5	62
BE-8920SL	T 20	3.84	100	20x122	5	62
BE-8925SL	T 25	4.40	125	27x122	5	77
BE-8930SL	T 30	5.49	150	36x122	5	129

Punta combinata SL/PH



		mm	mm		g
BE-8510SL	5 / PH1	80	20x122	5	60
BE-8520SL	6 / PH2	100	27x122	5	100

Punta combinata SL/PZ



		mm	mm		g
BE-8710SL	5 / PZ1	80	20x122	5	60
BE-8720SL	6 / PZ2	100	27x122	5	100

LE LAME SONO PIÙ SOTTILI DEL 30% RISPETTO ALLE NORMALI LAME ISOLATE PER UNA MIGLIORE ACCESSIBILITÀ (AD ESEMPIO VITI INCASSATE ED ELEMENTI A MOLLA)

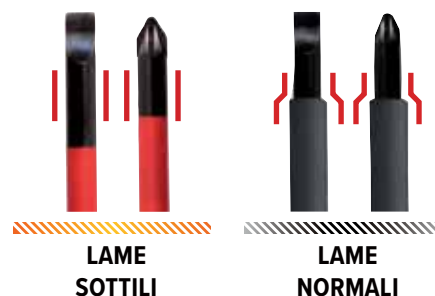

Assortimenti cacciavite isolati a lama sottile

Confezione appendibile con 2 cacciavite



Assortimento 2 pezzi

BE-9891SL	1	132
BE-8610SL, BE-8620SL PH1x80, PH2x100		



Assortimento 2 pezzi

BE-9890SL	1	175
BE-8710SL, BE-8720SL 5/PZ1, 6/PZ2, combi tip		



Assortimento 2 pezzi

BE-9894SL	1	132
BE-8810SL, BE-8820SL PZ1x80, PZ2x100		



XXL



Assortimento 4 pezzi

BE-9880SL	1	320
BE-8910SL, BE-8915SL, BE-8920SL, BE-8925SL T10x100, T15x100, T20x100, T25x125		



Assortimento 5 pezzi

BE-9882SL	1	440
BE-8220SL, BE-8040SL, BE-8050SL 0.5x3.0x75, 0.8x4.0x100, 1.0x5.5x125		
BE-8810SL, BE-8820SL PZ1x80, PZ2x100		



Assortimento 5 pezzi

BE-9881SL	1	440
BE-8220SL, BE-8040SL, BE-8050SL 0.5x3.0x75, 0.8x4.0x100, 1.0x5.5x125		
BE-8610SL, BE-8620SL PH1x80, PH2x100		



Assortimento 12 pezzi

BE-9878SL	1	900
BE-8010S 0.4x2.5x75 standard		
BE-8220SL, BE-8230SL, BE-8040SL, BE-8050SL 0.5x3.0x75, 0.5x3.5x100, 0.8x4.0x100, 1.0x5.5x125		
BE-8610SL / BE-8620SL PH1x80, PH2x100		
BE-8810SL, BE-8820SL PZ1x80, PZ2x100		
BE-8910SL T10x100		
BE-8510SL, BE-8520SL 5/PH1, 6/PH2, combi tip		



Cacciavite isolati standard

Intaglio semplice



BE-8010S	0.4	2.5	75	17x103	5	30
BE-8220S	0.5	3	100	17x103	5	33
BE-8230S	0.6	3.5	100	17x103	5	33
BE-8040S	0.8	4	100	20x122	5	33
BE-8050S	1.0	5.5	125	27x122	5	62
BE-8255S	1.2	6.5	150	36x122	5	105
BE-8065S	1.2	8	175	36x122	5	127
BE-8258S	1.6	10	200	36x165	5	270
BE-8259S	2.0	12	200	36x165	5	280

Phillips



BE-8600S		PH 0	75	17x103	5	31
BE-8610S		PH 1	80	27x122	5	64
BE-8611S		PH 1	80	20x122	5	33
BE-8612S		PH 1	150	27x122	5	155
BE-8620S		PH 2	100	36x122	5	108
BE-8621S		PH 2	100	27x122	5	75
BE-8622S		PH 2	175	36x122	5	175
BE-8630S		PH 3	150	36x122	5	159
BE-8640S		PH 4	200	36x165	5	268

Pozidriv



BE-8800S		PZ 0	75	17x103	5	31
BE-8810S		PZ 1	80	27x122	5	64
BE-8811S		PZ 1	80	20x122	5	33
BE-8812S		PZ 1	150	27x122	5	155
BE-8820S		PZ 2	100	36x122	5	110
BE-8821S		PZ 2	100	27x122	5	75
BE-8822S		PZ 2	175	36x122	5	175
BE-8830S		PZ 3	150	36x122	5	159
BE-8840S		PZ 4	200	36x161	5	268

Torx®



BE-8905S		T 5	1.42	75	17x103	5	200
BE-8906S		T 6	1.70	75	17x103	5	200
BE-8907S		T 7	1.99	75	20x122	5	200
BE-8908S		T 8	2.31	75	20x122	5	200
BE-8909S		T 9	2.50	75	20x122	5	200
BE-8910S		T 10	2.72	100	20x122	5	33
BE-8915S		T 15	3.26	125	27x122	5	62
BE-8920S		T 20	3.84	125	27x122	5	62
BE-8925S		T 25	4.40	150	27x122	5	77
BE-8930S		T 30	5.49	175	36x122	5	129

Esagonale



BE-8725S		2.5	100	17x103	5	33
BE-8703S		3	125	20x122	5	62
BE-8704S		4	150	20x122	5	78
BE-8705S		5	175	27x122	5	128
BE-8706S		6	150	27x122	5	159
BE-8708S		8	200	36x122	5	235

Esagonale maschio



BE-7855S		5.5	27x122	125	20x122	5	62
BE-7806S		6	27x122	125	20x122	5	64
BE-7807S		7	27x122	125	27x122	5	100
BE-7808S		8	27x122	125	27x122	5	104
BE-7809S		9	36x122	125	36x122	5	136
BE-7810S		10	36x122	125	36x122	5	140

Cacciavite isolati combinati





IEC 60900  1000V  

Alcuni compiti richiedono utensili speciali.
Ecco perché abbiamo creato degli speciali cacciavite combinati da utilizzare in morsettiere, armadi di controllo, interruttori, relè o simili.









Cacciavite combinato isolato per vite intaglio semplice e Phillips

Punta combinata SL/PH

 IEC60900  1000V  







						
BE-8510S	5 / PH1	80	27x122	5	60	
BE-8520S	6 / PH2	100	36x122	5	100	









Cacciavite combinato isolato per vite intaglio semplice e Pozidriv

Punta combinata SL/PZ

 IEC60900  1000V  



						
BE-8710S	5 / PZ1	80	27x122	5	60	
BE-8720S	6 / PZ2	100	36x122	5	100	



Assortimenti cacciavite ERGO™ isolati

Confezione appendibile
con 2 cacciavite



IEC60900 1000V

Assortimento 2 pezzi

BE-9890S	1	450
BE-8710S, BE-8720S 5/PZ1, 6/PZ2, combi tip		



IEC60900 1000V

Assortimento 5 pezzi

BE-9881S	1	450
BE-8220S, BE-8040S, BE-8050S 0.5x3x100, 0.8x4x100, 1x5.5x125		
BE-8610S, BE-8620S PH1x80, PH2x100		

IEC60900 1000V

Assortimento 5 pezzi

BE-9882S	1	450
BE-8220S, BE-8040S, BE-8050S 0.5x3x100, 0.8x4x100, 1x5.5x125		
BE-8810S, BE-8820S PZ1x80, PZ2x100		

IEC60900 1000V

Assortimento 6 pezzi

BE-9884S	1	450
BE-8220S, BE-8040S 0.5x3x100, 0.8x4x100		
BE-8810S, BE-8820S PZ1x80, PZ2x100		
BE-8710S, BE-8720S 5/PZ1, 6/PZ2, combi tip		

IEC60900 1000V

Assortimento 5 pezzi

BE-9885S	1	455
806-11 0.6x3x65		
BE-8510S, BE-8520S 5/PH1, 6/PH2, combi tip		
BE-8710S, BE-8720S 5/PZ1, 6/PZ2, combi tip		

Assortimento **5 pezzi**

BE-9871SL	1	450
BE-8040SL 0.8x4.0x100		
BE-8220SL 0.5x3x100		
BE-8610SL, BE-8620SL PH1x80, PH2x100		
BE-8910SL T10x100		

Assortimento **5 pezzi**

BE-9872 SL	1	450
BE-8040SL 0.8x4.0x100		
BE-8220SL 0.5x3x100		
BE-8810SL PZ1x80		
BE-8910SL, BE-8920SL T10x100, T20x100		

Assortimento **7 pezzi**

BE-9887S	1	460
806-1-1 0.6x3x65		
BE-8010S, BE-8230S, BE-8040S, BE-8050S 0.4x2.5x75, 0.6x3.5x100, 0.8x4.0x100, 1.0x5.5x125		
BE-8610S, BE-8621S PH1x80, PH2x100		

Assortimento **7 pezzi**

BE-9889S	1	450
806-1-1 0.6x3x65		
BE-8010S, BE-8230S, BE-8040S, BE-8050S 0.4x2.5x75, 0.6x3.5x100, 0.8x4.0x100, 1.0x5.5x125		
BE-8810S, BE-8821S PZ1x80, PZ2x100		

Assortimento **7 pezzi**

BE-9888S	1	530
BE-8010S, BE-8220S, BE-8040S, BE-8050S 0.4x2.5x75, 0.5x3.0x100, 0.8x4.0x100, 1.0x5.5x125		
BE-8800S, BE-8820S, BE-8830S PZ0x75, PZ2x100, PZ3x150		

Assortimento **14 pezzi**

BE-9876S	1	1076
BE-8010S, BE-8220S, BE-8230S, BE-8040S, BE-8050S 0.4x2.5x75, 0.5x3x100, 0.6x3.5x100, 0.8x4.0x100, 1.0x5.5x125		
BE-8610S, BE-8620S PH1x80, PH2x100		
BE-8810S, BE-8820S PZ1x80, PZ2x100		
BE-8910S, BE-8915S, BE-8920S T10x100, T15x125, T20x125		
BE-8710S, BE-8720S 5/PZ1, 6/PZ2, combi tip		







**Cacciavite ERGO™
acciaio inossidabile**

Cacciavite in acciaio inossidabile

L'acciaio inox è un materiale leader per i requisiti di massima qualità sia nel settore dell'interior design che in quello dell'edilizia. L'**acciaio inox** è resistente alla corrosione e agli antiacidi, è resistente agli agenti atmosferici, è igienico e facile da pulire. L'acciaio inox non arrugginito svolge un ruolo importante in settori come l'industria alimentare, le applicazioni mediche, le applicazioni offshore

e l'ingegneria automobilistica. Tuttavia, la ruggine può formarsi anche sull'acciaio inossidabile non arrugginito a causa del contatto con un utensile contaminato. Questo lascia sulla superficie dell'acciaio inossidabile delle particelle estranee che poi arrugginiscono. Questa "ruggine estranea" non è solo un problema estetico, ma anche una minaccia per la sicurezza.



Ecco perché l'acciaio inossidabile non arrugginito ha bisogno di utensili in acciaio inossidabile non arrugginito.

L'acciaio inossidabile protegge dalla formazione di ruggine che può verificarsi quando i lavori di avvitamento sull'acciaio inossidabile vengono eseguiti con utensili in acciaio non inossidabile.

UTENSILI IN ACCIAIO INOX POSSONO ESSERE UTILIZZATI CON VITI NON IN ACCIAIO INOX

Tuttavia, le viti in acciaio inossidabile necessitano di utensili in acciaio inossidabile. Il motivo è che il contatto con gli utensili convenzionali crea particelle «estranee» sulla superficie dell'acciaio inossidabile e, se esposte all'ossigeno, iniziano ad arrugginire.

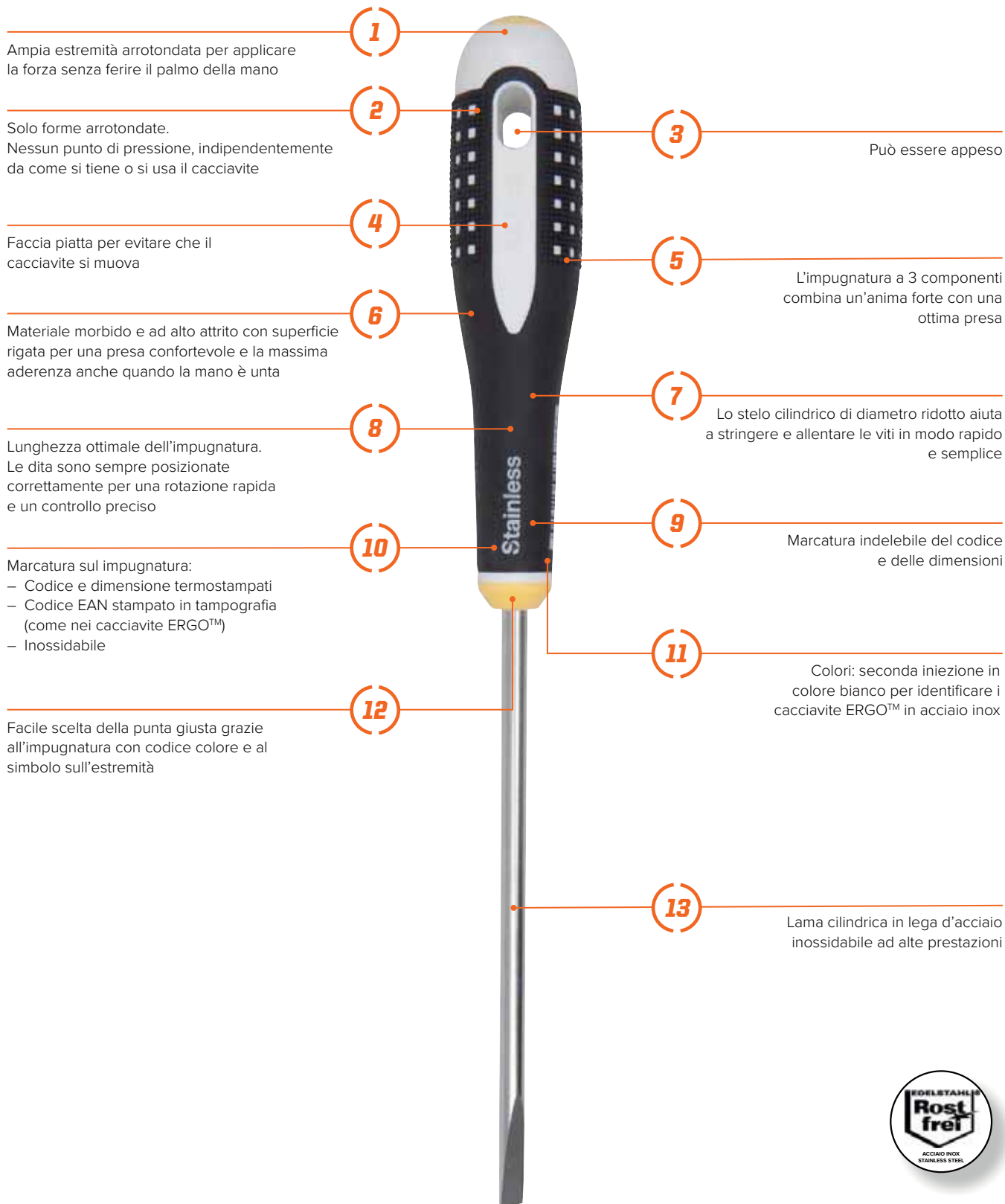

1 Ampia estremità arrotondata per applicare la forza senza ferire il palmo della mano

2 Solo forme arrotondate. Nessun punto di pressione, indipendentemente da come si tiene o si usa il cacciavite

4 Faccia piatta per evitare che il cacciavite si muova

6 Materiale morbido e ad alto attrito con superficie rigata per una presa confortevole e la massima aderenza anche quando la mano è unta

8 Lunghezza ottimale dell'impugnatura. Le dita sono sempre posizionate correttamente per una rotazione rapida e un controllo preciso

10 Marcatura sull'impugnatura:
– Codice e dimensione termostampati
– Codice EAN stampato in tampografia (come nei cacciavite ERGO™)
– Inossidabile

12 Facile scelta della punta giusta grazie all'impugnatura con codice colore e al simbolo sull'estremità

3 Può essere appeso

5 L'impugnatura a 3 componenti combina un'anima forte con una ottima presa

7 Lo stelo cilindrico di diametro ridotto aiuta a stringere e allentare le viti in modo rapido e semplice

9 Marcatura indelebile del codice e delle dimensioni

11 Colori: seconda iniezione in colore bianco per identificare i cacciavite ERGO™ in acciaio inox

13 Lama cilindrica in lega d'acciaio inossidabile ad alte prestazioni



Intaglio semplice

Dritto



BE-8020i	0.5	3.0	60	17x103	5	30
Be-8030i	0.6	3.5	75	17x103	5	34
BE-8040i	0.8	4.0	100	20x122	5	39
BE-8241i	1.0	5.5	125	27x122	5	44
BE-8252i	1.2	6.5	150	36x122	5	47

Phillips



BE-8600i	PH 0	60	17x103	5	30	
BE-8610i	PH 1	75	27x122	5	62	
BE-8620i	PH 2	100	36x122	5	106	
BE-8623i	PH 3	150	36x122	5	150	

Pozidriv



BE-8800i	PZ 0	60	17x103	5	30	
BE-8810i	PZ 1	75	27x122	5	62	
BE-8820i	PZ 2	100	36x122	5	106	
BE-8823i	PZ 3	150	36x122	5	150	

Torx®



BE-8910i	T 10	2.72	75	20x122	5	30
BE-8915i	T 15	3.26	100	27x122	5	55
BE-8920i	T 20	3.84	100	27x122	5	60
BE-8925i	T 25	4.40	125	27x122	5	70



Assortimenti cacciavite



Assortimento **6 pezzi**

BE-9881i	1	450
BE-8020i, BE-8040i, BE-8241i, BE-8252i 0.5x3x60, 0.8x4x100, 1.0x5.5x125, 1.2x6.5x150		
BE-8610i, BE-8620i PH1x75, PH2x100		



Assortimento **6 pezzi**

BE-9882i	1	450
BE-8020i, BE-8040i, BE-8241i, BE-8252i 0.5x3x60, 0.8x4x100, 1.0x5.5x125, 1.2x6.5x150		
BE-8810i, BE-8820i PZ1x75, PZ2x100		



Utensili antiscintilla

Bahco ha una gamma di utensili antiscintilla che soddisfa i severi requisiti di sicurezza di diversi settori, come quello petrolifero e del gas, quello minerario e altri settori in cui esiste il rischio di incendio o esplosione a causa di scintille, le cosiddette zone ATEX (“Atmosphères Explosibles”). Il rischio di esplosione è legato a vapori combustibili o

facilmente infiammabili. L'utilizzo di utensili che non producono scintille aiuta a proteggere l'utilizzatore e il luogo di lavoro e garantisce una maggiore sicurezza.

Con l'evolversi delle normative, sempre più aziende, in vari settori, hanno la necessità di utensili antiscintilla per garantire una maggiore sicurezza.



GLI UTENSILI ANTISCINTILLA SONO COMUNEMENTE UTILIZZATI NEI SETTORI PETROLCHIMICO/CHIMICO, PRODUZIONE DI PETROLIO E GAS, TRASPORTO DI GAS E RAFFINERIE. CERTIFICATI DALL'ISTITUTO BAM

Intaglio semplice

Piatto, Rame-Berillio



NSB300-4.5-100	0.5	4.5	100	20x122	1	50
NSB300-6-100	0.8	6	100	27x122	1	75
NSB300-8-150	1.2	8	150	36x122	1	130
NSB300-10-300	1.8	10	200	36x122	1	245
NSB300-11-350	2	11	350	36x122	1	320
NSB300-12-400	2.4	12	400	36x122	1	415
NSB300-13-450	2.4	13	450	36x122	1	460

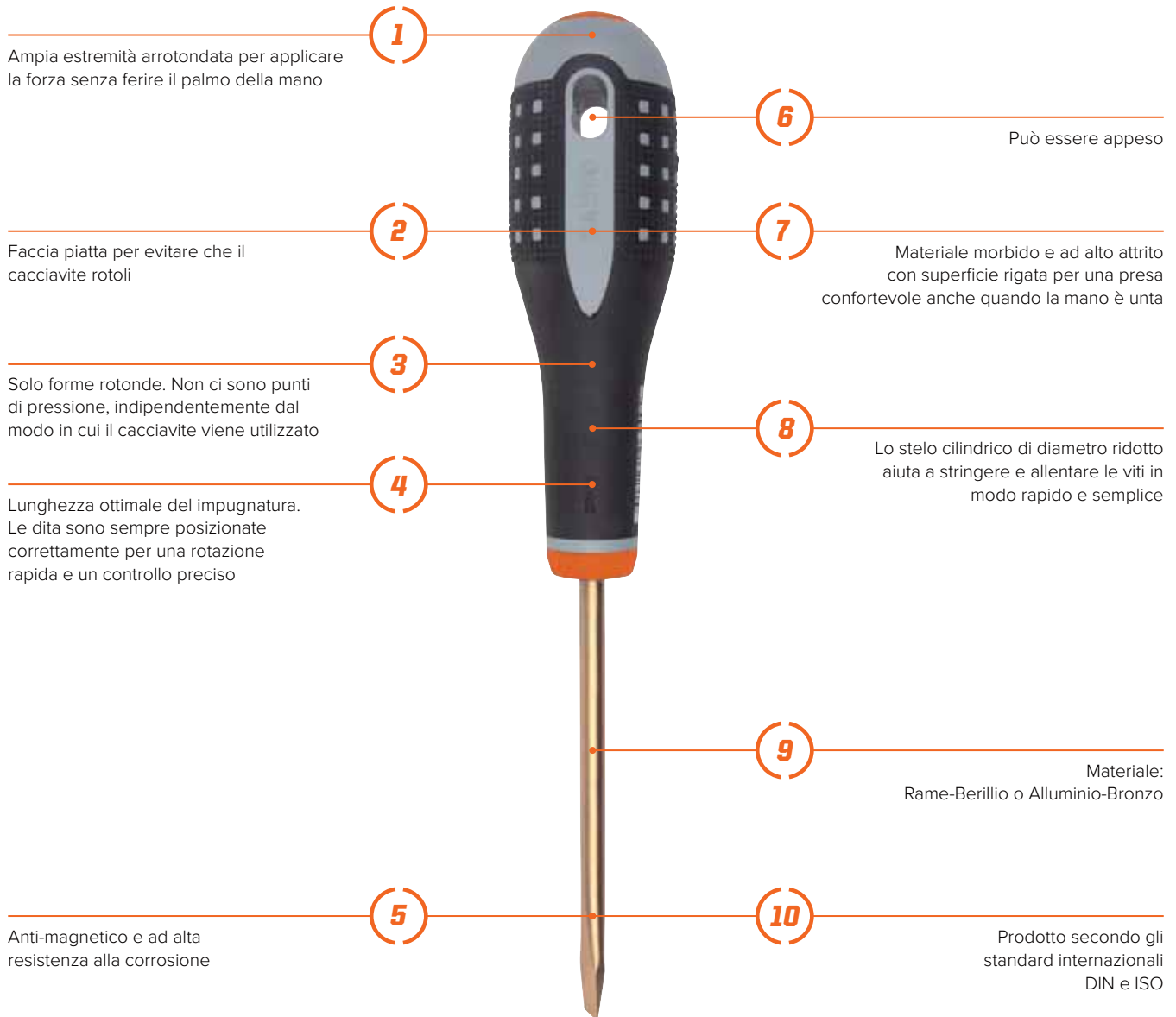

1
Ampia estremità arrotondata per applicare la forza senza ferire il palmo della mano

6
Può essere appeso

2
Faccia piatta per evitare che il cacciavite rotoli

7
Materiale morbido e ad alto attrito con superficie rigata per una presa confortevole anche quando la mano è unta

3
Solo forme rotonde. Non ci sono punti di pressione, indipendentemente dal modo in cui il cacciavite viene utilizzato

8
Lo stelo cilindrico di diametro ridotto aiuta a stringere e allentare le viti in modo rapido e semplice

4
Lunghezza ottimale dell'impugnatura. Le dita sono sempre posizionate correttamente per una rotazione rapida e un controllo preciso

9
Materiale:
Rame-Berillio o Alluminio-Bronzo

5
Anti-magnetico e ad alta resistenza alla corrosione

10
Prodotto secondo gli standard internazionali DIN e ISO

Alluminio-Bronzo



Icona	mm	mm	mm	mm	mm	g
	0.5	3	50	20x122	1	35
	0.8	4	100	20x122	1	50
	0.8	4	150	20x122	1	130
	1	5	100	20x122	1	50
	1	5	200	27x122	1	180
	1	6	100	27x122	1	50
	1.2	8	150	36x122	1	130
	1.6	10	200	36x122	1	180
	1.6	10	300	36x122	1	230

Rame-Berillio



Icona	mm	mm	mm	mm	mm	g
	0.5	3	50	20x122	1	35
	0.8	4	100	20x122	1	50
	0.8	4	150	20x122	1	130
	1	5	100	20x122	1	50
	1	5	200	27x122	1	180
	1	6	100	27x122	1	50
	1.2	8	150	36x122	1	130
	1.6	10	200	36x122	1	180
	1.6	10	300	36x122	1	230



— Intaglio semplice

Alluminio-Bronzo



NS300-3-50	0.4	3	50	20x122	1	35	
NS300-3-75	0.4	3	75	20x122	1	35	
NS300-4-75	0.5	4	75	20x122	1	45	
NS300-4.5-50	0.5	4.5	50	20x122	1	43	
NS300-4.5-100	0.5	4.5	100	20x122	1	50	
NS300-5-75	0.6	5	75	20x122	1	70	
NS300-5-100	0.6	5	100	20x122	1	75	
NS300-6-100	0.8	6	100	27x122	1	75	
NS300-6-125	0.8	6	125	27x122	1	100	
NS300-6-150	0.8	6	150	27x122	1	110	
NS300-7-150	1	7	150	27x122	1	125	
NS300-8-150	1.2	8	150	36x122	1	130	
NS300-8-200	1.2	8	200	36x122	1	165	
NS300-9-250	1.4	9	250	36x122	1	185	
NS300-10-200	1.8	10	200	36x122	1	165	
NS300-10-300	1.8	10	300	36x122	1	245	
NS300-11-250	2	11	250	36x122	1	260	
NS300-11-300	2	11	300	36x122	1	320	
NS300-11-350	2	11	350	36x122	1	320	
NS300-12-400	2.4	12	400	36x122	1	415	
NS300-13-450	2.4	13	450	36x122	1	460	

Rame-Berillio



NSB300-3-50	0.4	3	50	20x122	1	35	
NSB300-3-75	0.4	3	75	20x122	1	35	
NSB300-4-75	0.5	4	75	20x122	1	45	
NSB300-4.5-50	0.5	4.5	50	20x122	1	43	
NSB300-4.5-100	0.5	4.5	100	20x122	1	50	
NSB300-5-75	0.6	5	75	20x122	1	70	
NSB300-5-100	0.6	5	100	20x122	1	75	
NSB300-6-100	1.0	6	100	27x122	1	75	
NSB300-6-125	0.8	6	125	27x122	1	100	
NSB300-6-150	0.8	6	150	27x122	1	110	
NSB300-7-150	1	7	150	27x122	1	125	
NSB300-8-150	1.2	8	150	36x122	1	130	
NSB300-8-200	1.2	8	200	36x122	1	165	
NSB300-9-250	1.4	9	250	36x122	1	185	
NSB300-10-200	1.8	10	200	36x122	1	165	
NSB300-10-300	1.8	10	200	36x122	1	245	
NSB300-11-250	2	11	250	36x122	1	260	
NSB300-11-300	2	11	300	36x122	1	320	
NSB300-11-350	2	11	350	36x122	1	320	
NSB300-12-400	2.4	12	400	36x122	1	415	
NSB300-13-450	2.4	13	450	36x122	1	460	

+ Phillips

Rame-Berillio



NSB302-0-50	PH 0	50	20x122	1	35	
NSB302-1-100	PH 1	100	20x122	1	50	
NSB302-2-125	PH 2	125	27x122	1	80	
NSB302-3-150	PH 3	150	36x122	1	130	
NSB302-4-300	PH 4	300	36x122	1	230	

Alluminio-Bronzo



NS302-0-50	PH 0	50	20x122	1	35	
NS302-1-100	PH 1	100	20x122	1	50	
NS302-2-125	PH 2	125	27x122	1	80	
NS302-3-150	PH 3	150	36x122	1	130	
NS302-4-300	PH 4	300	36x122	1	230	

+ Pozidriv

Rame-Berillio



NSB304-0-50	PZ 0	50	20x122	1	35	
NSB304-1-100	PZ 1	100	20x122	1	50	
NSB304-2-125	PZ 2	125	27x122	1	80	
NSB304-3-150	PZ 3	150	36x122	1	130	
NSB304-4-300	PZ 4	300	36x122	1	230	

Alluminio-Bronzo



NS304-0-50	PZ 0	50	20x122	1	35	
NS304-1-100	PZ 1	100	20x122	1	50	
NS304-2-125	PZ 2	125	27x122	1	80	
NS304-3-150	PZ 3	150	36x122	1	130	
NS304-4-300	PZ 4	300	36x122	1	230	



UTENSILI ANTICADUTA

Bahco è membro di DROPS (Dropped Objects Prevention Scheme), un'iniziativa a livello industriale incentrata sulla prevenzione della caduta degli oggetti, con l'obiettivo finale di fornire una strategia di prevenzione in tutto il nostro settore. Tutte le nostre

soluzioni di utensili sono approvate secondo le pratiche DROPS. Per ogni utensile, Bahco ha sviluppato la soluzione migliore per lavorare in quota. Ogni soluzione è certificata e non può essere smontata.

IL COMPITO FONDAMENTALE DI DROPS È QUELLO DI PRENDERE IN CONSIDERAZIONE TUTTE LE STRADE DISPONIBILI PER MIGLIORARE LA PREVENZIONE DELLA CADUTA DEGLI OGGETTI.



DROPS

Esaminano e identificano gli insegnamenti chiave e li trasmettono al settore sotto forma di consapevolezza, migliori pratiche, raccomandazioni, lezioni, strumenti e tecniche.

DROPS è un gruppo di lavoro globale, rappresentato da 200 operatori, appaltatori, società di servizi ed enti del settore, tutti accomunati dall'impegno e dall'entusiasmo per l'obiettivo comune della prevenzione della caduta degli oggetti.

TUTTE LE SOLUZIONI SVILUPPATE DA BAHCO

1

Mandrino di sicurezza

Progettato per i cacciavite per consentire la libera rotazione dell'utensile



2

Cordino in Kevlar

Tessuto molto robusto e resistente al fuoco utilizzato per il cacciavite isolato con colla speciale per evitare lo smontaggio



3

Cordino in Dyneema

Tessuto estremamente resistente. Morbido ma molto resistente, con una chiusura in alluminio per evitare lo smontaggio



Intaglio semplice



Model	Tip Width (mm)	Tip Length (mm)	Shaft Length (mm)	Shaft Diameter (mm)	Weight (g)
TAHBE-8020L	0.5	3	75	20x122	33
TAHBE-8030	0.6	3.5	75	20x122	34
TAHBE-8040	0.8	4	100	20x122	39
TAHBE-8241	1	5.5	150	27x122	47
TAHBE-8252	1.2	6.5	150	36x122	47



Model	Tip Width (mm)	Tip Length (mm)	Shaft Length (mm)	Shaft Diameter (mm)	Weight (g)
TAHBE-8155	1.2	6.5	125	36x122	112
TAHBE-8257	1.6	8	175	36x122	140
TAHBE-8258	1.6	10	200	36x161	195



Model	Tip Width (mm)	Tip Length (mm)	Shaft Length (mm)	Shaft Diameter (mm)	Weight (g)
TAHBE-8260	1.6	8	175	36x122	112



Model	Tip Width (mm)	Tip Length (mm)	Shaft Length (mm)	Shaft Diameter (mm)	Weight (g)
TAHBE-8350	1	5.5	25	36x58	40

Rilascio del perno



Model	Tip Width (mm)	Tip Length (mm)	Shaft Length (mm)	Shaft Diameter (mm)	Weight (g)
TAHPINRELEASER	6	50	36x58	1	64

Phillips



Model	Tip Width (mm)	Tip Length (mm)	Shaft Length (mm)	Shaft Diameter (mm)	Weight (g)
TAHBE-8610	PH 1	75	27x122	1	62
TAHBE-8611	PH 1	75	20x122	1	62
TAHBE-8620	PH 2	100	36x122	1	106
TAHBE-8620L	PH 2	200	36x122	1	127
TAHBE-8623	PH 3	150	36x122	1	150
TAHBE-8624	PH 4	200	36x165	1	225



Model	Tip Width (mm)	Tip Length (mm)	Shaft Length (mm)	Shaft Diameter (mm)	Weight (g)
TAHBE-8630	PH 3	150	36x122	14	173



Model	Tip Width (mm)	Tip Length (mm)	Shaft Length (mm)	Shaft Diameter (mm)	Weight (g)
TAHBE-8602	PH 2	25	36x58	1	43

Pozidriv



Model	Tip Width (mm)	Tip Length (mm)	Shaft Length (mm)	Shaft Diameter (mm)	Weight (g)
TAHBE-8810	PZ 1	75	27x122	1	62
TAHBE-8820	PZ 2	100	36x122	1	106



Model	Tip Width (mm)	Tip Length (mm)	Shaft Length (mm)	Shaft Diameter (mm)	Weight (g)
TAHBE-8830	PZ 3	150	36x122	14	173





TAHBE-8910	T 10	2.72	75	20x122	1	31
TAHBE-8915	T 15	3.26	100	27x122	1	57
TAHBE-8920	T 20	3.84	100	27x122	1	57
TAHBE-8925	T 25	4.40	125	27x122	1	70
TAHBE-8930	T 30	5.49	150	36x122	1	119

Cacciavite isolati

Intaglio semplice

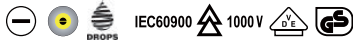

TAHBE-8040S	0.8	4	100	20x122	1	33
TAHBE-8050S	1.0	5.5	125	27x122	1	62
TAHBE-8220S	0.5	3	100	20x122	1	33
TAHBE-8255S	1.2	6.5	150	36x122	1	105

Phillips



TAHBE-8610S	PH 1	80	27x122	1	64	
TAHBE-8620S	PH 2	100	36x122	1	108	
TAHBE-8630S	PH 3	150	36x122	1	159	
TAHBE-8640S	PH 4	200	36x165	1	268	

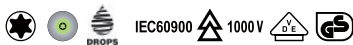

TAHBE-8910S	T 10	2.72	75	20x122	1	40
TAHBE-8915S	T 15	3.26	75	27x122	1	62
TAHBE-8920S	T 20	3.84	75	27x122	1	62
TAHBE-8925S	T 25	4.4	75	27x122	1	77
TAHBE-8930S	T 30	5.49	75	36x122	1	129

Pozidriv

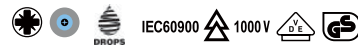

TAHBE-8820SL	PZ 2	100	36x122	1	100	





E191
AV100



BAHCOFit

«Per tutti, per tutto»

Quando il cacciavite Premium fu presentato nel 1993, nemmeno noi potevamo immaginare che sarebbe diventato il leader indiscusso nella cassetta degli attrezzi di ogni professionista. La sfida che abbiamo affrontato dopo 22 anni è stata quella di sviluppare e lanciare un cacciavite di nuova generazione, una sfida che abbiamo raccolto e che siamo certi diventerà un'altra pietra miliare della nostra storia. Un prodotto che è stato ispirato dalla nostra divisione di Ricerca, Sviluppo e Innovazione e realizzato nel nostro stabilimento di produzione di cacciavite.

100% made in Spain.

BahcoFit ha un design brevettato dell'impugnatura, il 75% della quale è in gomma, con scanalature verticali che garantiscono una presa perfetta. Unitamente alle lame in acciaio legato ad alte prestazioni e a più di 50 anni di produzione di milioni di cacciavite, il risultato è un prodotto finito di altissima qualità. **BahcoFit** è ora il cacciavite giusto per i professionisti:

- **Adattato alla mano**, e non viceversa
- **Ottimo per tutti i tipi di utilizzo e di esigenze**
- **Sviluppato per le esigenze moderne**



1 L'estremità arrotondata ti permette di applicare la forza senza ferire il palmo della mano

2 Manico a 2 componenti con più del 75% di materiale in gomma

3 Punta con simbolo indelebile. Facile scegliere la punta giusta

4 Piccoli aree per le dita su entrambi i lati del collo per un'applicazione di precisione

5 Acciaio legato ad alte prestazioni

6 Punta nera per una maggiore precisione

7 Può essere appeso

8 Scanalature verticali per una presa confortevole e la massima aderenza; antiscivolo

9 Marcatura laser delle dimensioni

10 Materiale morbido e ad alto attrito con superficie rigata per una presa confortevole e la massima aderenza anche quando la mano è unta

11 Codice sulla lama marcato al laser



Intaglio semplice

Piatto



B190.040.075	0.8	4.0	75	24.5x95	10	44
B190.040.100	0.8	4.0	100	24.5x95	10	44
B190.055.100	1.0	5.5	100	30x105	10	66
B190.055.125	1.0	5.5	125	30x105	10	70
B190.065.125	1.2	6.5	125	34x117	10	102
B190.065.150	1.2	6.5	150	34x117	10	102
B190.080.150	1.6	8.0	150	34x117	10	110
B190.080.175	1.6	8.0	175	34x117	10	120
B190.100.200	1.6	10.0	200	34x117	10	170
B190.120.250	2.0	12.0	250	34x117	10	220
B190.140.250	2.5	14.0	250	34x117	10	220

Dritto



B191.025.075	0.4	2.5	75	24.5x95	10	20
B191.030.075	0.5	3.0	75	24.5x95	10	27
B191.030.100	0.5	3.0	100	24.5x95	10	28
B191.030.200	0.5	3.0	200	24.5x95	10	30
B191.035.100	0.6	3.5	100	24.5x95	10	30
B191.040.100	0.8	4.0	100	24.5x95	10	44
B191.040.125	0.8	4.0	125	24.5x95	10	47
B191.040.250	0.8	4.0	250	24.5x95	10	60
B191.055.125	1.0	5.5	125	30x105	10	70
B191.055.150	1.0	5.5	150	30x105	10	79
B191.055.300	1.0	5.5	300	30x105	10	105
B191.065.150	1.2	6.5	150	34x117	10	100
B191.065.300	1.2	6.5	300	34x117	10	140

Extra corto



B195.040.025	0.8	4.0	25	33x60	5	38
B195.050.025	1.0	5.0	25	33x60	10	38
B195.060.025	1.2	6.0	25	33x60	10	40

QUAL È LA DIFFERENZA TRA DIRITTO E PIATTO?

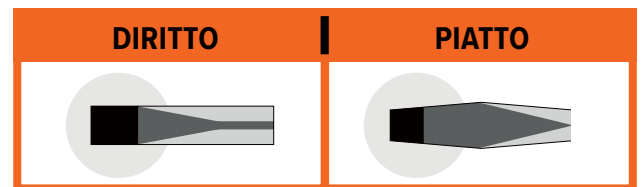

I CACCIAVITE BAHCOFIT SONO DISPONIBILI IN CONFEZIONE SELF-SERVICE AGGIUNGENDO UNA «S» PRIMA DEL CODICE



Phillips



B192.000.075	PH 0	75	24.5x95	10	27	
B192.000.200	PH 0	200	24.5x95	10	38	
B192.001.100	PH 1	100	30x105	10	65	
B192.001.250	PH 1	250	30x105	10	90	
B192.002.125	PH 2	125	34x117	10	97	
B192.002.150	PH 2	150	34x117	10	97	
B192.002.300	PH 2	300	34x117	10	130	
B192.003.150	PH 3	150	34x117	10	150	
B192.004.200	PH 4	200	34x117	10	190	

Extra corto



B195.001.025	PH 1	25	33x60	10	40	
B195.002.025	PH 2	25	33x60	10	40	



Pozidriv



B193.000.075		PZ 0	75	24.5x95	10	30
B193.001.100		PZ 1	100	30x105	10	65
B193.002.125		PZ 2	125	34x117	10	97
B193.003.150		PZ 3	150	34x117	10	153
B193.004.200		PZ 4	200	34x117	10	202

Extra corto



B195.901.025		PZ 1	25	33x60	10	30
B195.902.025		PZ 2	25	33x60	10	40



Torx®



B194.004.075		T 4	1.30	75	24.5x95	10	20
B194.005.075		T 5	1.37	75	24.5x95	10	25
B194.006.075		T 6	1.65	75	24.5x95	10	20
B194.007.075		T 7	1.97	75	24.5x95	10	30
B194.008.075		T 8	2.30	75	24.5x95	10	26
B194.009.075		T 9	2.48	75	24.5x95	10	28
B194.010.075		T 10	2.72	75	24.5x95	10	27
B194.015.100		T 15	3.26	100	24.5x95	10	44
B194.020.100		T 20	3.84	100	24.5x95	10	40
B194.025.125		T 25	4.40	125	30x105	10	70
B194.027.125		T 27	4.96	125	30x105	10	73
B194.030.150		T 30	5.49	150	34x117	10	100
B194.040.150		T 40	6.60	150	34x117	10	110
B194.045.150		T 45	7.70	150	34x117	5	120

TORX® Tamper resistant



B141.007.075		TR 7	1.97	75	24.5x95	5	27
B141.008.075		TR 8	2.30	75	24.5x95	5	30
B141.009.075		TR 9	2.48	75	24.5x95	5	30
B141.010.075		TR 10	2.72	75	24.5x95	5	20
B141.015.100		TR 15	3.26	100	24.5x95	5	40
B141.020.100		TR 20	3.84	100	24.5x95	5	40
B141.025.125		TR 25	4.40	125	30x105	5	60
B141.027.125		TR 27	4.96	125	30x105	5	73
B141.030.150		TR 30	5.49	150	34x117	5	100
B141.040.150		TR 40	6.60	150	34x117	5	120



Esagonale





B143.020.100		2	100	24.5x95	5	29
B143.025.100		2.5	100	24.5x95	10	30
B143.030.100		3	100	24.5x95	10	30
B143.040.100		4	100	24.5x95	10	50
B143.050.100		5	100	30x105	10	75
B143.060.125		6	125	34x117	10	111
B143.080.150		8	150	34x117	5	130

ESAGONALE TESTA SFERICA

Cacciavite per vite esagonale, con estremità sferica, facile da inserire nella testa della vite da una serie di angolazioni, fino a 30°, per un accesso migliore rispetto alla punta esagonale standard.





Robertson

Model	Size	Length (mm)	Tip Width (mm)	Tip Height (mm)	Pieces	Weight (g)
B144.001.100	# 1	100	24,5x95	5	40	
B144.002.125	# 2	125	30x105	5	70	
B144.003.150	# 3	150	34x117	5	100	



Esagonale maschio

Model	Size (mm)	Tip Size (mm)	Length (mm)	Tip Width (mm)	Tip Height (mm)	Pieces	Weight (g)
B198.040.125	4.0	7x30	125	24,5x95	5	60	
B198.045.125	4.5	7x30	125	24,5x95	5	69	
B198.050.150	5.0	8x30	150	30x105	5	80	
B198.055.150	5.5	8x30	150	30x105	5	70	
B198.060.150	6.0	9x30	150	30x105	5	80	
B198.060.150F	6.0	11x27	150	30x105	5	80	
B198.070.150	7.0	11x30	150	34x117	5	105	
B198.070.150F	7.0	11x27	150	34x117	5	100	
B198.080.150	8.0	12x30	150	34x117	5	118	
B198.080.150F	8.0	13x27	150	34x117	5	118	
B198.090.150	9.0	13x30	150	34x117	5	110	
B198.100.150	10.0	14x30	150	34x117	5	164	
B198.110.150	11.0	16x30	150	34x117	5	170	
B198.120.150	12.0	17x30	150	34x117	5	170	
B198.130.150	13.0	18x30	150	34x117	5	170	
B198.140.150	14.0	19x30	150	34x117	5	185	

Alesatore



Punta quadrata

Model	Size (mm)	Length (mm)	Tip Width (mm)	Tip Height (mm)	Pieces	Weight (g)
B146.006.100	6	100	30x105	5	70	

Punteruolo

Punta tonda

Model	Size (mm)	Length (mm)	Tip Width (mm)	Tip Height (mm)	Pieces	Weight (g)
B145.006.100	6	100	30x105	5	70	



Extra corto





Model	Size (mm)	Length (mm)	Tip Width (mm)	Tip Height (mm)	Pieces	Weight (g)
B195.006.050	6	50	33x60	5	40	

Portainseri magnetico

Model	Size	Length (mm)	Tip Width (mm)	Tip Height (mm)	Pieces	Weight (g)
B705.1/4.125	1/4"	125	30x105	5	130	

Assortimenti cacciavite BahcoFit



Nuovo disegno della confezione

Inserto termoformato prodotto in Spagna

Le finestre consentono di toccare il prodotto

Scatola personalizzata per ogni assortimento



Assortimento 2 pezzi

B219.002	1	120
B191 0.8x4.0x100		
B192 PH1x100		



Assortimento 5 pezzi

B219.005	1	355
B191 0.5x3.0x75; 0.8x4.0x100		
B190 1.0x5.5x125		
B192 PH1x100; PH2x125		



Assortimento 4 pezzi

B219.004	1	300
B191 0.5x3.0x100; 1.0x5.5x125		
B192 PH1x100; PH2x125		



Assortimento 5 pezzi

B219.015	1	355
B191 0.5x3.0x75; 0.8x4.0x100		
B190 1.0x5.5x125		
B193 PZ1x100; PZ2x125		



Assortimenti cacciavite BahcoFit



Assortimento 5 pezzi

B219.025	1	360
B194 T10x75; T15x100; T20x100; T25x125; T30x150		



Assortimento 5 pezzi

B219.035	1	355
B141 TR10x75; TR15x100; TR20x100; TR25x125; TR30x150		



Assortimento 6 pezzi

B219.006	1	450
B191 0.5x3.0x75; 0.8x4.0x100		
B190 1.0x5.5x125; 1.2x6.5x125		
B192 PH1x100; PH2x125		



Assortimento 6 pezzi

B219.016	1	450
B191 0.5x3.0x75; 0.8x4.0x100		
B190 1.0x5.5x125; 1.2x6.5x125		
B193 PZ1x100; PZ2x125		



Assortimento 4 pezzi

B219.014	1	375
B192 PH0x75; PH1x100; PH2x125; PH3x150		



Assortimento 6 pezzi

B219.026	1	450
B191 0.5x3.0x75; 0.8x4.0x100		
B192 PH1x100; PH2x125		
B193 PZ1x100; PZ2x125		



Assortimento 7 pezzi

B219.007	1	530
B193 PZ1x100; PZ2x125		
B194 T10x75; T15x100; T20x100; T25x125; T30x150		



Assortimento 7 pezzi

B219.017	1	530
B191 0.6x3.5x100; 0.8x4.0x100		
B190 1.0x5.5x125; 1.2x6.5x125; 1.6x8.0x150		
B192 PH1x100; PH2x125		



Assortimento 7 pezzi

B219.027	1	625
B194 T10x75; T15x100; T20x100; T10x75 T25x125; T27x125; T30x150		



Assortimento 8 pezzi

B219.008	1 540
B191 0.8x4.0x100; 1.0x5.5x125	
B190 1.2x6.5x150; 1.6x8.0x175	
B192 PH1x100; PH2x125	
B195 1.2x6.0x25	
B195 PH2x25	



Assortimento 10 pezzi

B219.010	1 630
B191 3.0x75	
B190 1.0x5.5x100; 6.5x125; 8.0x150	
B192 PH1x100; PH2x125; PH3x150	
B193 PZ2x25	
B144 R1x100; R2x125	

* In alloggiamento termoformato



Assortimento 4 pezzi

B219.004 + MTT121	1 400
B191 0.5x3.0x100; 1.0x5.5x125	
B192 PH1x100; PH2x125	
MTT121	



Assortimento 2 pezzi

B219.012	1 182
B190 1.0x5.5x125	
B192 PH2x125	



Assortimento 5 pezzi

B219.045	1 419
B191 0.5x3x100; 0.8x 4.0x125	
B190 1.0x5.5x125; 1.2x6.5x150; 1.6x8.0x175	



Assortimento 10 pezzi

B219.110	1 680
806-1-1 0.6x3.0x65 (150-250V)	
B142 PZ1x80	
B190 1x5.5x100	
B192 PH2x125	
B193 PZ2x125	
B194 T10x75; T15x100; T20x100	
B196 0.4x2.5x75; 0.8x4x100	



Assortimento 10 pezzi

B219.210	1 630
B194 T6x75; T8x75; T9x75; T10x75; T15x100; T20x100; T25x125; T27x125; T30x125; T40x150	



BAHCOFit Cacciavite isolati

- Per lavorare su apparecchiature sotto tensione, fino a 1000 V
- Impugnatura: bicomponente con foro per appendere
- Lama in acciaio di alta qualità, stampata direttamente nel manico
- Punta con finitura nera per una migliore precisione
- Ispezionato individualmente e prodotto secondo la norma IEC 60900



1 L'estremità arrotondata ti permette di applicare la forza senza ferire il palmo della mano

2 Manico a 2 componenti con più del 75% di materiale in gomma

3 Punta con simbolo indelebile. Facile scegliere la punta giusta

4 Piccoli aree per le dita su entrambi i lati del collo per un'applicazione di precisione

5 Lama realizzata in acciaio legato ad alte prestazioni per maggiore resistenza e affidabilità. Isolamento stampato direttamente sulla lama

6 Può essere appeso

7 Scanalature verticali per una presa confortevole e la massima aderenza; antiscivolo

8 Materiale morbido e ad alto attrito con superficie rigata per una presa confortevole e la massima aderenza anche quando la mano è unta

9 Codice prodotto e misure stampati sull'impugnatura

10 Anno di produzione

11 La punta nera garantisce un'aderenza precisa e non si sfalda

I CACCIAVITE BAHCOFIT SONO DISPONIBILI IN CONFEZIONE SELF-SERVICE AGGIUNGENDO UNA «S» PRIMA DEL CODICE

TUTTI I CACCIAVITE ISOLATI SONO TESTATI AL 100% SEGUENDO UN RIGOROSO CONTROLLO DI QUALITÀ. I CACCIAVITE BAHCO SONO UNA GARANZIA DI QUALITÀ E SICUREZZA.

Intaglio semplice



B196.025.075	0.4	2.5	75	24.5x95	10	36
B196.030.100	0.5	3.0	100	24.5x95	10	38
B196.035.100	0.6	3.5	100	24.5x95	10	38
B196.040.100	0.8	4.0	100	24.5x95	10	38
B196.055.125	1.0	5.5	125	24.5x95	10	66
B196.065.150	1.2	6.5	150	30x105	10	90
B196.080.175	1.2	8.0	175	34x117	10	140
B196.100.200	1.6	10.0	200	34x117	10	189
B196.120.200	2.0	12.0	200	34x117	10	205
SB196.025.075	0.4	2.5	75	24.5x95	1	40
SB196.030.100	0.5	3.0	100	24.5x95	1	42
SB196.035.100	0.6	3.5	100	24.5x95	1	42
SB196.040.100	0.8	4.0	100	24.5x95	1	42
SB196.055.125	1.0	5.5	125	24.5x95	1	70
SB196.065.150	1.2	6.5	150	30x105	1	94
SB196.080.175	1.2	8.0	175	34x117	1	144
SB196.100.200	1.6	10.0	200	34x117	1	193
SB196.120.200	2.0	12.0	200	34x117	1	200

Phillips



B197.000.075		PH 0	75	24.5x95	10	30
B197.001.080		PH 1	80	24.5x95	10	40
B197.001.150		PH 1	150	30x105	10	90
B197.002.100		PH 2	100	30x105	10	82
B197.002.175		PH 2	175	34x117	10	140
B197.003.150		PH 3	150	34x117	10	150
B197.004.200		PH 4	200	34x117	10	190
SB197.000.075		PH 0	75	24.5x95	1	34
SB197.001.080		PH 1	80	24.5x95	1	44
SB197.002.100		PH 2	100	30x105	1	86
SB197.003.150		PH 3	175	34x117	1	154
SB197.004.200		PH 4	200	34x117	1	194

Pozidriv



B142.000.075		PZ 0	75	24.5x95	10	30
B142.001.080		PZ 1	80	24.5x95	10	40
B142.001.150		PZ 1	150	30x105	10	90
B142.002.100		PZ 2	100	30x105	10	80
B142.002.175		PZ 2	175	34x117	10	140
B142.003.150		PZ 3	150	34x117	10	150
SB142.000.075		PZ 0	75	24.5x95	1	34
SB142.001.080		PZ 1	80	24.5x95	1	44
SB142.002.100		PZ 2	100	30x105	1	84
SB142.003.150		PZ 3	150	34x117	1	154

Esagonale maschio



B199.055.125		5.5	125	30x105	5	91
B199.060.125		6.0	125	30x105	5	127
B199.070.125		7.0	125	34x117	5	127
B199.080.125		8.0	125	34x117	5	142
B199.090.125		9.0	125	34x117	5	142
B199.100.125		10.0	125	34x117	5	142
B199.110.125		11.0	125	34x117	5	181
B199.120.125		12.0	125	34x117	5	182
B199.130.125		13.0	125	34x117	5	183
SB199.055.125		5.5	125	30x105	1	95
SB199.060.125		6.0	125	30x105	1	131
SB199.070.125		7.0	125	34x117	1	131
SB199.080.125		8.0	125	34x117	1	146
SB199.090.125		9.0	125	34x117	1	146
SB199.100.125		10.0	125	34x117	1	146
SB199.110.125		11.0	125	34x117	1	185
SB199.120.125		12.0	125	34x117	1	186
SB199.130.125		13.0	125	34x117	1	187

Torx®



B150.010.100		T 10	2.72	100	24.5x95	10	38
B150.015.125		T 15	3.26	125	24.5x95	10	66
B150.020.125		T 20	3.84	125	24.5x95	10	70
B150.025.150		T 25	4.40	150	30x105	10	90
SB150.010.100		T 10	2.72	100	24.5x95	1	42
SB150.015.125		T 15	3.26	125	24.5x95	1	70
SB150.020.125		T 20	3.84	125	24.5x95	1	74
SB150.025.150		T 25	4.40	150	30x105	1	94



Cacciavite BahcoFit isolati

⊕ Punta combinata SL/PH



⊕ IEC60900 ⚡ 1000V ⚠ Ⓢ

	⊕	mm	mm		g
B148.001.080	5 / PH1	80	24.5x95	10	50
B148.002.100	6 / PH2	100	30x105	10	80
SB148.001.080	5 / PH1	80	24.5x95	1	54
SB148.002.100	6 / PH2	100	30x105	1	84

⊕ Punta combinata SL/PZ



⊕ IEC60900 ⚡ 1000V ⚠ Ⓢ

	⊕	mm	mm		g
B149.001.080	5 / PZ1	80	24.5x95	10	50
B149.002.100	6 / PZ2	100	30x105	10	80
SB149.001.080	5 / PZ1	80	24.5x95	1	54
SB149.002.100	6 / PZ2	100	30x105	1	84

Assortimenti cacciavite isolati BahcoFit

- Nuovo disegno della confezione
- Inserto termoformato prodotto in Spagna
- Le finestre consentono di toccare il prodotto
- Scatola personalizzata per ogni assortimento

⊕ IEC60900 ⚡ 1000V ⚠ Ⓢ Assortimento 2 pezzi

			g
B220.002			90
B196 0.5x3.0x100	⊖		
B197 PH1x80	⊕		

* Confezione appendibile con 2 cacciavite

⊕ IEC60900 ⚡ 1000V ⚠ Ⓢ Assortimento 5 pezzi

			g
B220.005			450
B196 0.5x3.0x100; 0.8x4.0x100; 1.0x5.5x125	⊖		
B197 PH1x80; PH2x100	⊕		



Assortimento **5 pezzi**

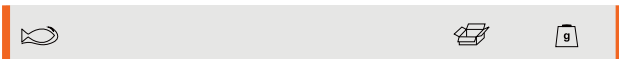

B220.015 1 450

B196
0.6x3.5x100; 0.8x4.0x100;
1.2x6.5x125



B142
PZ1x80; PZ2x100



Assortimento **7 pezzi**

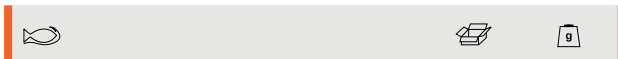

B220.007 1 530

B196
0.5x3.0x100; 0.8x 4.0x100;
1.0x5.5x125; 1.2x6.5x150



B197
PH0x75; PH1x80; PH2x100



Assortimento **7 pezzi**

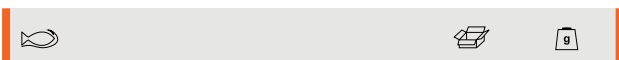

B220.017 1 530

B196
0.4x2.5x75; 0.8x4.0x100;
1.0x5.5x125; 1.2x6.5x150



B142
PZ0x75; PZ1x80; PZ2x100



Assortimento **7 pezzi**

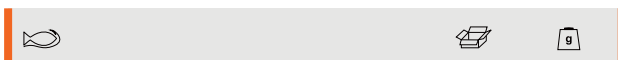

B220.027 1 460

B196
0.5x3.0x100; 0.8x4.0x100;
1.0x5.5x125



B197
PH0x75; PH1x80; PH2x100



806-1-1
0.6x3.0x65 (150-250V)







Serie 600

La **serie 600** completa l'ampia gamma di cacciavite Bahco. Questo assortimento di cacciavite resistenti comprende due tipologie: **standard e isolati**, entrambe con la gamma di profili di punta più richiesta.



Intaglio semplice

Piatto



611-3.5-75		0.6	3.5	50	25x80	10	30
611-3.5-100		0.6	3.5	100	25x80	10	31
611-4-100		0.8	4.0	100	25x80	10	37
611-5.5-100		1.0	5.5	100	25x80	10	63
611-5.5-125		1.0	5.5	100	30x97	10	68
611-6.5-25		1.2	6.5	125	35x68	10	43
611-6.5-125		1.2	6.5	125	35x110	10	100
611-6.5-150		1.2	6.5	150	35x110	10	103
611-8-150		1.2	8.0	150	35x110	10	115
611-8-175		1.2	8.0	175	35x110	10	127
611-10-200		1.6	10.0	200	35x110	10	160

Dritto



613-3-75		0.5	3.0	75	25x80	10	30
613-3-100		0.5	3.0	100	25x80	10	31
613-3.5-100		0.60	3.5	100	25x80	10	33
613-4-100		0.8	4.0	100	25x80	10	37
613-4-125		0.80	4.0	125	25x80	10	41
613-5.5-150		1.0	5.5	150	30x97	10	78
613-6.5-150		1.20	6.5	150	35x110	10	110

Phillips



615-0-75		PH 0	75	25x80	10	30	
615-1-100		PH 1	100	30x97	10	63	
615-2-25		PH 2	25	35x65	10	43	
615-2-125		PH 2	125	35x110	10	98	
615-3-150		PH 3	150	35x110	10	113	

Pozidriv



616-0-75		PZ 0	75	25x80	10	30	
616-1-100		PZ 1	100	30x97	10	63	
616-2-125		PZ 2	25	60x110	10	98	
616-3-150		PZ 3	125	35x110	10	113	

Torx®



618-10-75		T 10	2.72	75	25x80	10	30
618-15-100		T 15	3.26	100	25x80	10	37
618-20-100		T 20	3.84	100	25x80	10	37
618-25-125		T 25	4.40	125	30x97	10	68
618-27-125		T 27	4.96	125	30x97	10	68
618-30-150		T 30	5.49	150	35x110	10	103
618-40-150		T 40	6.60	150	35x110	10	115



Assortimenti cacciavite serie 600



Assortimento 3 pezzi

600-3	1	210
611 5.5x125		
613 3x100		
615 PH1x100		



Assortimento 6 pezzi

605-6	1	445
613 3x75, 4x100		
615 PH1x100, PH2x125		
616 PZ1x100, PZ2x125		



Assortimento 4 pezzi

602-4-LA	1	315
613 3x100		
611 5.5x125		
615 PH1x100, PH2x125		



Assortimento 6 pezzi

606-6	1	445
611 5.5x100, 6.5x125		
613 3x75, 4x100		
615 PH1x100, PH2x125		



Assortimento 5 pezzi

604-5	1	385
613 3x100		
611 4x100, 6.5x125		
615 PH1x100, PH2x125		



Assortimento 6 pezzi

610-6	1	445
611 5.5x100, 6.5x125		
613 3x75, 4x100		
616 PZ1x100, PZ2x125		



Assortimento 5 pezzi

612-5	1	348
618 T10, T15, T20, T25, T30		



Assortimento 10 pezzi

605-10-PC-AU	1	1000
611 5.5x100, 6.5x125, 8x150		
613 3x75		
615 PH 1x100, PH2x125, PH3x150		
616 PZ2x25		
619 R1x100, R2x100		



Assortimento 6 pezzi

605-6-PC	1	830
613 3x100, 6.5x150		
615 PH1x100, PH2x125		
616 PZ1x100, PZ2x125		

Cacciavite serie 600 isolati

- Per lavorare su apparecchiature sotto tensione, fino a 1000 V
- Impugnatura: bicomponente con foro per appendere
- Lama in acciaio di alta qualità, stampata direttamente nel manico
- Punta con finitura nera per una migliore precisione
- Ispezionato individualmente e prodotto secondo la norma **IEC 60900**



1 Il foro nel manico consente di utilizzare una barra a "T" per aumentare la forza o di appendere il cacciavite

2 Elastomero e polipropilene per una trasmissione della coppia efficace e confortevole

3 Lama realizzata in acciaio legato ad alte prestazioni per una maggiore resistenza e affidabilità. Isolamento stampato direttamente sulla lama

4 Dimensioni e codice contrassegnati sull'impugnatura

5 Polipropilene per un'elevata resistenza e un'articolazione perfetta dell'impugnatura

6 La punta nera garantisce un'aderenza precisa

Intaglio semplice



Modello	Spessore (mm)	Lunghezza (mm)	Spessore (mm)	Lunghezza (mm)	Pacchetti	Peso (g)
623-3-100	0.5	3.0	100	25x80	10	32
623-3.5-100	0.6	3.5	100	25x80	10	32
623-4-100	0.8	4.0	100	25x80	10	33
623-5-125	1.0	5.5	125	30x97	10	61
623-6-150	1.2	6.5	150	35x110	10	94

Phillips



Modello	Spessore (mm)	Lunghezza (mm)	Spessore (mm)	Lunghezza (mm)	Pacchetti	Peso (g)
625-0-100	PH 0	100	25x80	10	32	
625-1-150	PH 1	150	30x97	10	68	
625-2-175	PH 2	175	35x110	10	116	

Assortimento cacciavite



Assortimento 6 pezzi

Modello	Spessore (mm)	Lunghezza (mm)	Pacchetti	Peso (g)
620-6	3x100; 4x100; 5.5x125; 6.5x150	1	465	







**Cacciavite a
cricchetto**

Le caratteristiche del prodotto, come il cricchetto a 48 denti, l'impugnatura bicomponente per una presa eccellente, la cartuccia con inserti e la funzione di

illuminazione a led, rendono il tuo lavoro più semplice ed efficiente.

Tutti i prodotti hanno lo stesso look distintivo Bahco, un design ineguagliabile.

Cacciavite a cricchetto 808050

Cacciavite a cricchetto con luce LED 808050L

DEPOSITO PER INSERTI

Il portainseriti contiene 6 punte



Il meccanismo di qualità garantisce un'elevata capacità di trasferimento della forza

Parte zigrinata per una rotazione rapida

Stelo in acciaio legato

Efficiente dispositivo magnetico: Portainseriti magnetico da 1/4"

1 Impugnatura di forma ovale con superficie ad alto attrito per una maggiore coppia e comfort

2 Pulsanti autoesplicativi

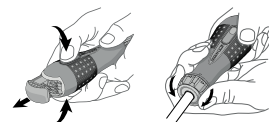

3 Tre modalità di funzionamento: in senso orario, antiorario e fisso

LE LUCI LED DI LUNGA DURATA MONTATE SULL'INVOLUCRO ANTERIORE FORNISCONO ILLUMINAZIONE IN CONDIZIONI DI OSCURITÀ



3 batterie LR41 e 2 luci AG-3 4,5V incluse

808050

808050L



Cacciavite a cricchetto con impugnatura a pistola 808050P

DEPOSITO PER INSERTI

Il portainseri contiene
6 punte



Il meccanismo di qualità
garantisce un'elevata capacità di
trasferimento della forza

Parte zigrinata per una
rotazione rapida

Stelo in acciaio legato

Portainseri magnetico da 1/4"



1

Impugnatura di forma ovale
con superficie ad alto attrito per
una maggiore coppia e comfort

2

L'impugnatura è
girevole e si blocca in posizione
di pistola per l'applicazione di
coppie più elevate

Modalità pistola

3

Pulsanti autoesplicativi

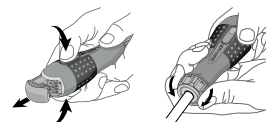

8

Anello di inversione per una rapida
selezione della modalità.
Funzionamento in senso orario,
antiorario e fisso

4

5

6

7



Cacciavite a cricchetto con impugnatura a T 808050TS

1 Comoda impugnatura a T disassata per la massima forza, coppia e comfort

2 Il meccanismo di qualità garantisce un'elevata capacità di trasferimento della forza

3 Resistenza e affidabilità: Stelo in acciaio legato



808050TS

Cacciavite a cricchetto extra corto 808050S

4 Impugnatura compatta per accedere agli spazi ristretti

5 Tre modalità di funzionamento: in senso orario, antiorario e fisso

6 Portainseri magnetico da 1/4"



808050S

Gamma di cacciavite a cricchetto

Cacciavite a cricchetto

808050	1/4	125	100	1	270
PH1, PH2, PZ1, PZ2, SL4,5, SL5,5					

Cacciavite a cricchetto con LED

808050L	1/4	135	45x140	1	215
PH1, PH2, PZ1, PZ2, SL4,5, SL5,5					
808050L-SP1	Pannello led di ricambio + 3 batterie AG-3, 4,5V		1	-	

Cacciavite a cricchetto con impugnatura a pistola

808050P	1/4	135	45x125	1	270
PH1, PH2, PZ1, PZ2, SL4,5, SL5,5					

Cacciavite portainseri

808050A	1/4	115	45x115	1	150
PH1, PH2, PZ1, PZ2, SL4,5, SL5,5					
808050TORX	1/4	115	45x115	1	150
T10, T15, T20, T25, T30, T40					

Cacciavite a cricchetto con impugnatura a T



808050TS 1/4 25 90x70 1 165

Cacciavite a cricchetto extra corto



808050S 1/4 25 40x70 1 135

Assortimenti cacciavite



Assortimento 25 pezzi



808050P-25 **Cacciavite a cricchetto con impugnatura a pistola** 1 1400

1 cacciavite a cricchetto con impugnatura a pistola con portainseriti
 6 inserti da 25 mm 1/4" nel portainseriti del cacciavite:
 PH 1, PH 2, PZ 1, PZ 2, intaglio semplice 4,5 e 5,5 mm
 3 chiavi a cricchetto:
 8x10-9x11 mm, 12x14-13x15 mm e 16x17-18x19 mm
 1 adattatore per bussola da 1/4" x 1/4" nel portainseriti
 1 adattatore per inserti da 1/4" 10 mm reversibile
 13 inserti da 25 mm 1/4":
 PH 3, PZ 3, SL 6.5, HEX 3, HEX 4, HEX 5, T-10, T-15, T-20,
 T-25, T-27, T-30, T-40



Assortimento 22 pezzi



808050S-22 **Assortimento cacciavite a cricchetto extra-corto** 1 530

1 cacciavite a cricchetto con attacco quadro estraibile
 17 inserti S2 al fosfato di zinco:
 PH 1, PH 2, PH 3, PZ 1, PZ 2, T-10, T-15, T-20, T-25, T-27, T-30, T-40,
 SL 4, SL 5, SL 5.5, SL 6.5, SL 1/4"
 1 adattatore bussole 1/4" x 1/4"
 1 portainseriti vite esagonale 1/4" attacco quadro 1/4" 50 mm
 (tipo intercambiabile)
 1 adattatore bussole flessibile attacco quadro 1/4" x 1/4" 150 mm
 1 adattatore portainseriti 1/4" x 1/4"
 5 chiavi a bussola 1/4": 4, 5, 6, 7, 8 mm



Assortimento 18 pezzi



808050S-18 **Assortimento cacciavite a cricchetto extra-corto** 1 530

1 cacciavite a cricchetto extra-corto con attacco quadro estraibile
 8 inserti con finitura zincata/fosfatata S2: PH 1, PH 2, PZ 1, PZ 2,
 T-15, T-20, SL 4, HEX 3
 1 adattatore bussole 1/4" x 1/4"
 1 portainseriti vite esagonale 1/4" attacco quadro 1/4" 50 mm
 (tipo intercambiabile)
 1 cacciavite a cricchetto extra-corto con lama con attacco quadro estraibile
 1 adattatore bussole flessibile attacco quadro 1/4" x 1/4" 150 mm
 1 adattatore portainseriti 1/4" x 1/4"
 5 chiavi a bussola 1/4": 4, 5, 6, 7, 8 mm



808060 Cacciavite a cricchetto

Il modello 808060 è un cacciavite a cricchetto isolato con lame sottili intercambiabili, un' **innovazione rivoluzionaria** realizzata in uno degli **stabilimenti Bahco in Europa**. Il sistema di rilascio delle lame integrato nella comoda impugnatura consente di cambiare le lame sottili in modo facile e sicuro, senza che queste cadano.

Le lame sono più sottili del 30% rispetto a quelle di un normale cacciavite isolato, per una migliore accessibilità e un maggior numero di applicazioni (ad esempio viti incassate ed elementi a molla).

Un utensile indispensabile per gli elettricisti e i professionisti della manutenzione.



**Impugnature e lame di ricambio
100 mm**



Modello	Impugnatura	L (mm)	Quantità	Peso (g)
808060	Impugnatura	100	1	115
8610SL-2P	PH1	100	2	40
8620SL-2P	PZ1	100	2	55
8810SL-2P	PH2	100	2	40
8820SL-2P	PZ2	100	2	55
8010SL-2P	0.4x2.5	100	2	40
8220SL-2P	0.5x3.0	100	2	40
8040SL-2P	0.8x4.0	100	2	55
8050SL-2P	1x5.5	100	2	55
8910SL-2P	T10	100	2	40
8915SL-2P	T15	100	2	40
8920SL-2P	T20	100	2	40
8925SL-2P	T25	100	2	55
8930SL-2P	T30	100	2	55
8510SL-2P	punta combinata PH1/5.0x100	100	2	40
8520SL-2P	punta combinata PH2/6.0x100	100	2	55
8710SL-2P	punta combinata PZ1/5.0x100	100	2	40
8720SL-2P	punta combinata PZ2/6.0x100	100	2	55



**Cacciavite a cricchetto isolato
con lame intercambiabili
100 mm**



Modello	Contenuto	L (mm)	Quantità	Peso (g)
808061	6 lame in un astuccio di nylon: PH1, PH2, 0.4x2.5, 0.5x3.0, 0.8x4.0, 1.0x5.5 + impugnatura	85x220	5	475
808062	6 lame in un astuccio di nylon: PZ1, PZ2, 0.4x2.5, 0.5x3.0, 0.8x4.0, 1.0x5.5 + impugnatura	85x220	5	475



product
design
award



**Cacciavite a cricchetto isolato
con lame intercambiabili
100 mm
5 SET IN ESPOSITORE**

Modello	Contenuto	L (mm)	Quantità	Peso (g)
808061	6 lame in un astuccio di nylon: PH1, PH2, 0.4x2.5, 0.5x3.0, 0.8x4.0, 1.0x5.5 + impugnatura	85x220	5	475
808062	6 lame in un astuccio di nylon: PZ1, PZ2, 0.4x2.5, 0.5x3.0, 0.8x4.0, 1.0x5.5 + impugnatura	85x220	5	475

ISOLATO

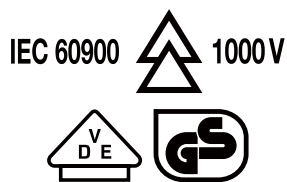

L'808060 è certificato secondo la norma IEC 60900 ed è adatto per lavorare su apparecchiature sotto tensione.

CRICCHETTO



Il modello 808060 è dotato di un meccanismo a cricchetto non conduttivo a 48 denti.

LAME SOTTILI

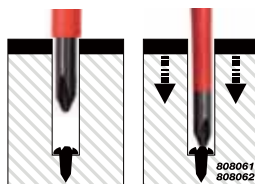

Le lame sono più sottili del 30% rispetto alle normali lame isolate per una migliore accessibilità (ad esempio, viti incassate ed elementi a molla).

LAME INTERCAMBIABILI



Sistema brevettato di rilascio della lama per cambiare le lame in modo facile e sicuro senza che la lama cada.







Precisione

Quando la precisione è d'obbligo

Cacciavite appositamente progettato per lavori di precisione, adatto ad applicazioni meccaniche ed elettroniche.

1 La testa rotante permette di posizionare perfettamente la punta per un movimento rapido e confortevole delle dita durante la rotazione, riducendo i tempi di serraggio

2 La combinazione di due componenti nel manico rende l'impugnatura confortevole e trasmette una coppia elevata alla lama

3 Acciaio legato ad alte prestazioni

4 La punta nera lavorata con precisione offre una aderenza ottimale

È FACILE TROVARE LA PUNTA GIUSTA NELLA TUA CASSETTA DEGLI ATTREZZI GRAZIE AL DOPPIO CODICE COLORE CHE NON SI USURA

- Intaglio semplice
- Phillips
- Pozidriv
- Torx®
- Esagonale testa sferica

Intaglio semplice



700-1-50	0.18	1	50	14x87	5	20	
700-1.2-50	0.20	1.2	50	14x87	5	20	
700-1.5-50	0.25	1.5	50	14x87	5	20	
700-1.8-50	0.30	1.8	50	14x87	5	20	
700-2-50	0.40	2	50	14x87	5	20	
700-2.5-50	0.40	2.5	50	14x87	5	22	
700-3-50	0.50	3	50	14x87	5	23	
700-3-100	0.50	3	100	14x87	5	24	
700-3-200	0.50	3	200	14x87	5	39	
700-3.5-75	0.60	3.5	75	14x87	5	26	
700-4-75	0.80	4	75	14x87	5	29	
700-4-250	0.80	4	250	14x87	5	61	

Torx®



703-4-50	T 4	1.30	50	14x87	5	21	
703-5-50	T 5	1.37	50	14x87	5	21	
703-6-50	T 6	1.65	50	14x87	5	21	
703-7-50	T 7	1.97	50	14x87	5	21	
703-8-50	T 8	2.30	50	14x87	5	23	
703-9-50	T 9	2.48	50	14x87	5	23	
703-10-50	T 10	2.72	50	14x87	5	23	
703-15-75	T 15	3.26	75	14x87	5	30	
703-20-75	T 20	3.84	75	14x87	5	30	

Phillips



701-00-50	PH 00	50	14x87	5	20		
701-0-50	PH 0	50	14x87	5	23		
701-0-200	PH 0	200	14x87	5	39		
701-1-75	PH 1	75	14x87	5	29		
701-1-250	PH 1	250	14x87	5	61		

Esagonale testa sferica



704-1.5-50	1.5	50	14x87	5	21		
704-2-50	2	50	14x87	5	21		
704-2.5-50	2.5	50	14x87	5	21		
704-3-75	3	75	14x87	5	26		
704Z-3/32	3/32	75	14x87	5	26		

Pozidriv



702-0-50	PZ 0	50	14x87	5	23		
702-1-75	PZ 1	75	14x87	5	29		



TORX® TESTA SFERICA

Il profilo di guida sferico consente di lavorare con un'angolazione fino a 30° con la massima efficacia. Le punte TORX® a testa sferica sono necessarie per avvitare in punti stretti o angolati.



PUNTA NERA = MAGGIORE PRECISIONE

Punta con finitura nera.

È un processo di ossidazione che non aggiunge alcuno strato, quindi la punta è più precisa.

Usa la punta con finitura nera per ottenere una maggiore precisione.

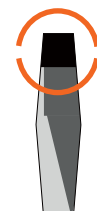

Assortimenti cacciavite



Assortimento 6 pezzi

706-1	1	240
700 1.5x50; 2.0x50; 2.5x50; 3.0x50		
701 PH0x50; PH1x75		



Assortimento 7 pezzi

706-4	1	350
700 1.5x50; 2.5x50; 3.5x75		
701 PH0x50; PH1x75		
703 T6x50; T8x50		



Assortimento 6 pezzi

706-2	1	226
700 1.0x50; 1.2x50; 1.5x50; 1.8x50		
701 PH00x50; PH0x50		



Assortimento 24 pezzi

706-5	1	820
700 1.0x50; 1.2x50; 1.5x50; 1.8x50; 2.0x50; 3.0x50; 3.5x75; 4x75		
701 PH00x50; PH0x50; PH1x75		
702 PZ0x50; PZ1x75		
703 T6x50; T7x50; T8x50; T9x50; T10x50; T15x75; T20x75		
704 H1,5x50; H2x50; H2,5x50; H3x75		



Assortimento 6 pezzi

706-3	1	222
700 1.0x50; 1.2x50; 1.5x50; 1.8x50; 2.0x50; 2.5x50		



Assortimento **4** pezzi

510034	0.25x1.5; 0.3x2; 0.4x2.5; 0.5x3	10	30



Assortimento **5** pezzi

98505	0.6; 0.8; 1.0; 1.5; 2.5 mm	5	70



Assortimento **6** pezzi

510031	1.0; 1.5; 2.0; 2.5; 3.0; 3.5 mm	5	145



Assortimento **3** pezzi

510033	PH000; PH00; PH0	5	85



2784-2.5	2.5	95	1	15
2784-3.5	3.5	110	1	25
2784-4.5	4.5	110	1	30



7372I-2-63	0.4	2.0	63	13x80	10	10
7372I-2.5-75	0.4	2.5	75	13x80	10	13
7372I-3-80	0.5	3.0	80	13x80	10	27



BAHCO 





Manico a T

Manico a T serie 900

Lo strumento ottimale per i lavori in cui è richiesta una coppia di serraggio elevata, combina le caratteristiche operative di una chiave a T con quelle di una chiave standard, con due lame posizionate a 90°.

1 Lama corta a 90° da utilizzare come chiave di manovra. Serraggio estremo, per operazioni con altezza limitata

2 L'impugnatura a due componenti e morbida offre un maggiore comfort e riduce i punti di pressione sulla mano

3 L'acciaio legato ad alte prestazioni garantisce una resistenza all'usura e una robustezza superiori. Codice e dimensioni impresse sulla lama

4 Lama lunga da usare come chiave a T. Fornisce un serraggio ad alta coppia per lavorare in aree difficili da raggiungere

5 La punta nera lavorata con precisione garantisce un'aderenza precisa

6 Il foro per appendere il manico consente di riporlo facilmente o di inserire una leva quando necessario

7 L'intera mano è a contatto con l'impugnatura, evitando la perdita di attrito tra la mano e l'impugnatura

8 La lama passante a forma di L è perfetta per le applicazioni che richiedono una coppia elevata

Esagonale



900T-020-100		2	103	50x85	5	23
900T-025-100		2,5	103	50x85	5	25
900T-030-100		3	103	50x85	5	28
900T-040-150		4	136	50x85	5	48
900T-050-150		5	136	60x105	5	59
900T-060-200		6	185	60x105	5	73
900T-080-200		8	185	60x105	5	150
900T-100-200		10	185	60x105	5	210

Portainseriti



904T-060-150		1/4	120	60x105	5	125

Torx®



901T-006-100		T 6	1.65	103	50x85	5	37
901T-007-100		T 7	1.97	103	50x85	5	37
901T-008-100		T 8	2.30	103	50x85	5	37
901T-009-100		T 9	2.48	103	50x85	5	37
901T-010-100		T 10	2.72	103	50x85	5	37
901T-015-150		T 15	3.26	136	50x85	5	42
901T-020-150		T 20	3.84	136	50x85	5	42
901T-025-150		T 25	4.40	136	60x105	5	49
901T-027-150		T 27	4.96	136	60x105	5	52
901T-030-200		T 30	5.49	185	60x105	5	61
901T-040-200		T 40	6.60	185	60x105	5	135
901T-045-200		T 45	7.70	185	60x105	5	135
901T-050-200		T 50	8.79	185	60x105	5	139

Prolunga con manico



905T-060-100		1/4	60	60x105	5	90

Vite esagonale maschia



902T-050-150		5	29	136	50x85	5	77
902T-055-150		5.5	29	136	50x85	5	77
902T-060-150		6	29	136	50x85	5	77
902T-070-175		7	29	160	60x105	5	77
902T-080-175		8	29	160	60x105	5	112
902T-090-175		9	29	160	60x105	5	98
902T-100-175		10	29	160	60x105	5	155
902T-110-175		11	29	160	60x105	5	155
902T-120-175		12	29	160	60x105	5	155
902T-130-175		13	29	160	60x105	5	155



Assortimenti cacciavite



Assortimento **6 pezzi**



903T-1

1

855

900T
3 - 4 - 5 - 6 - 8 - 10 mm



Assortimento **6 pezzi**



903T-2

1

400

901T
T 10, T 15, T 20, T 25, T 30, T 40



Assortimento **6 pezzi**



903T-3

1

810

902T
5 - 6 - 7 - 8 - 10 - 13 mm







BAHCO



5

4

3

2

6

8

10



Chiavi esagonali

Chiavi esagonali e Torx® colorate

- Set di 9 pezzi (misure esagonali: 1,5-10) (misure Torx®: T8-T40)
- Identificazione facile grazie al colore
- Supporto durevole con sensazione di morbidezza al tatto per organizzazione e sicurezza
- Impugnatura stampata a iniezione con sensazione di morbidezza al tatto: presa piacevole e antiscivolo in ogni applicazione. Resistente agli oli
- Finitura fosfatata: protezione contro la corrosione, per una lunga durata.
- Estremità a sfera: ideale per lavorare in spazi ristretti e difficili da raggiungere
- Marcatura laser e quindi indicazione della misura resistente all'usura e per un rapido accesso alla chiave desiderata



EASY FIT

Parte della chiave è più larga del resto del corpo, in modo che si inserisca correttamente nel supporto e si blocchi in quel punto, facendola trattenere e non cadere, e garantendone una facile estrazione

1

2 **BORDO MAGGIORATO**
Lo smusso viene effettuato in ogni bordo, rispettando la faccia esagonale, per aumentare la forza applicata e avere una maggiore superficie di contatto

3 **ANTISCIVOLO**
Le coperture sono antiscivolo grazie alla superficie ruvida del materiale, in modo che anche quando l'utensile è sporco di olio, la presa con la mano sia efficace per consentire un uso corretto

4 **SOVRASTAMPATO**
Essendo sovrastampato, il materiale riempie un anello centrale che impedisce la rimozione dei manicotti

Misure:

- 1.5
- 2
- 2.5
- 3
- 4
- 5
- 6
- 8
- 10

Assortimento chiavi esagonali

- Supporto compatto a 2 componenti, resistente agli urti
- Il magnete integrato nel supporto permette di magnetizzare e smagnetizzare quando necessario
- Il portachiavi pieghevole è disponibile in un'ampia gamma di combinazioni di chiavi
- Le dimensioni delle chiavi sono contrassegnate per facilitarne l'individuazione
- Facile accesso alle chiavi esagonali



Il magnete integrato nel supporto consente di magnetizzare e smagnetizzare quando necessario.



Assortimenti chiavi esagonali

- Tascabile
- Impugnatura morbida a 2 componenti
- Materiale resistente agli urti
- Pulsante ad ampia apertura per il rilascio automatico delle lame
- Per diverse posizioni di lavoro
- Arresto positivo a 270° per una leva massima
- Design compatto e facile da trasportare
- Confezione appendibile

1 L'ampia impugnatura migliora la presa. Tuttavia, fai attenzione quando lavori con le lame piccole, perché possono essere serrate eccessivamente

2 Parte interna in materiale plastico duro e resistente agli urti

3 Ampio pulsante di rilascio di facile accesso per il rilascio automatico delle chiavi esagonali. Quando si gira una chiave in posizione di lavoro, le chiavi rimanenti rimangono memorizzate

4 Materiale plastico morbido che ricopre la maggior parte della superficie e che offre una ottima presa

5 Le dimensioni delle chiavi sono contrassegnate per facilitarne l'individuazione





- 1 Supporto in plastica con foro per appendere
- 2 Tutte le dimensioni sono contrassegnate sul supporto per una facile identificazione
- 3 Supporto resistente agli urti
- 4 Facile accesso alle chiavi



- 1 Portafoglio di plastica
- 2 Taglie contrassegnate nella parte superiore del portafoglio per una facile selezione
- 3 Facile conservazione delle chiavi



- 1 Portachiavi
- 2 Molto pratico e funzionale

FINITURA CHIAVE

Nichelata

- Esagonale



Nera

- Esagonale
- Torx®





Esagonale

Finitura nichelata

Millimetri



	mm	mm	mm		g
1998M-1.5	1.5	15	47	10	1
1998M-2	2	18	52	10	1
1998M-2.5	2.5	21	59	10	3
1998M-3	3	23	66	10	4
1998M-4	4	29	74	10	10
1998M-5	5	33	85	10	18
1998M-6	6	38	96	10	29
1998M-7	7	41	102	10	41
1998M-8	8	44	108	10	57
1998M-9	9	47	114	5	76
1998M-10	10	50	122	5	100
1998M-12	12	57	137	5	163
1998M-14	14	70	154	1	253
1998M-17	17	80	177	1	427
1998M-19	19	89	199	1	600
1998M-22	22	102	222	1	910



	mm			g
1998M/8R	2; 2.5; 3; 4; 5; 6; 7; 8	8	1	175

Finitura nichelata

Testa sferica / Pollici



	mm			g
BE-9880	0,050; 1/16; 5/64; 3/32; 7/64; 1/8; 9/64; 5/32; 3/16; 7/32; 1/4; 5/16	12	3	240



	mm			g
BE-9778	1.5; 2; 2.5; 3; 4; 5; 6; 8; 10	9	1	305



	mm			g
BE-9878	1.5; 2; 2.5; 3; 4; 5; 6; 8; 10	9	1	305



	mm			g
1998M/6T	2; 2.5; 3; 4; 5; 6	6	1	76
1998M/8T	2; 2.5; 3; 4; 5; 6; 7; 8	8	1	180
1998M/10T	2; 2.5; 3; 4; 5; 6; 7; 8; 9; 10	10	1	380
1998M/11T	2; 2.5; 3; 4; 5; 6; 7; 8; 9; 10; 12	11	1	570
1998M/15T	2; 2.5; 3; 4; 5; 6; 7; 8; 9; 10; 12; 14; 17; 19; 22	15	1	2920

Finitura nera

Millimetri



Icona	mm	mm	mm	Icona	g
1995M-1.5	1.5	15	47	10	1
1995M-2	2	18	52	10	2
1995M-2,5	2.5	21	59	10	3
1995M-3	3	23	66	10	5
1995M-4	4	29	74	10	10
1995M-5	5	33	85	10	13
1995M-6	6	38	96	10	29
1995M-7	7	41	102	10	41
1995M-8	8	44	108	10	57
1995M-9	9	47	114	10	76
1995M-10	10	50	122	10	100
1995M-12	12	57	137	10	163
1995M-14	14	70	154	10	253
1995M-17	17	80	177	10	427
1995M-19	19	89	199	10	600
1995M-22	22	102	222	10	910



Icona	mm	mm	Icona	g
BE-9777B	2.5; 3; 4; 5; 6; 8; 10	7	6	290

Finitura fosfata

Lungo / Millimetri



Icona	mm	mm	mm	Icona	g
1995LM-1.5	1.5	15	91	10	1
1995LM-2	2	18	102	10	3
1995LM-2,5	2.5	21	114	10	5
1995LM-3	3	23	129	10	8
1995LM-4	4	29	144	10	17
1995LM-5	5	33	165	10	31
1995LM-6	6	38	186	10	51
1995LM-7	7	41	197	10	64
1995LM-8	8	44	208	10	100
1995LM-9	9	47	219	10	134
1995LM-10	10	50	234	10	175
1995LM-12	12	57	262	10	283
1995LM-14	14	70	294	10	439



Icona	mm	mm	Icona	g
1995M/6T	2; 2.5; 3; 4; 5; 6	6	1	75
1995M/8T	2; 2.5; 3; 4; 5; 6; 7; 8	8	1	180
1995M/10T	2; 2.5; 3; 4; 5; 6; 7; 8; 9; 10	10	1	365
1995M/11T	2; 2.5; 3; 4; 5; 6; 7; 8; 9; 10; 12	11	1	535
1995M/15T	2; 2.5; 3; 4; 5; 6; 7; 8; 9; 10; 12; 14; 17; 19; 22	15	1	2800



Icona	mm	mm	Icona	g
BE-9578	1.5; 2; 2.5; 3; 4; 5; 6; 8; 10	9	1	270



Icona	mm	mm	Icona	g
BE-9776	1.5; 2; 2.5; 3; 4; 5; 6	7	6	150
BE-9777	2.5; 3; 4; 5; 6; 8; 10	7	6	410



Icona	mm	mm	Icona	g
BE-9588	1.5; 2; 2.5; 3; 4; 5; 6; 8; 10	9	1	435

Il magnete integrato nel supporto permette di magnetizzare e smagnetizzare quando necessario



Esagonale

Finitura nera

Pollici



	mm	mm	mm		g
1995Z-1/16	1/16	15	47	10	1
1995Z-5/64	5/64	18	52	10	2
1995Z-3/32	3/32	21	59	10	3
1995Z-1/8	1/8	23	66	10	5
1995Z-5/32	5/32	29	74	10	10
1995Z-3/16	3/16	33	85	10	16
1995Z-7/32	7/32	35,5	91	10	24
1995Z-1/4	1/4	38	96	10	32
1995Z-5/16	5/16	44	108	10	60
1995Z-3/8	3/8	50	122	10	100
1995Z-7/16	7/16	53	129	10	140
1995Z-1/2	1/2	63	145	10	182
1995Z-5/8	5/8	76	168	10	370
1995Z-3/4	3/4	89	199	10	601

Finitura nera

Serie lunga, testa sferica



	mm	mm	mm		g
1996M-1.5	1.5	15	91	10	1
1996M-2	2	18	102	10	3
1996M-2.5	2.5	21	114	10	5
1996M-3	3	23	129	10	8
1996M-4	4	29	144	10	17
1996M-5	5	33	165	10	31
1996M-6	6	38	186	10	50
1996M-8	8	44	208	10	100
1996M-10	10	50	234	10	171
1996M-12	12	57	262	10	275



	mm			g
C1997LM/9P	1.5; 2; 2.5; 3; 4; 5; 6; 8; 10	9	1	586



	mm			g
BE-9787	3/32; 1/8; 5/32; 3/16; 1/4; 5/16; 3/8	7	6	410



	mm			g
BE-9688	1.5; 2; 2.5; 3; 4; 5; 6; 8; 10	9	1	450



Funzione di smagnetizzazione integrata nel supporto



	mm			g
BE-9775	5/64; 3/32; 1/4; 1/8; 1/16; 5/32; 3/16	7	3	70
BE-9780	0,050; 1/16; 5/64; 3/32; 7/64; 1/8; 9/64; 5/32; 3/16; 7/32; 1/4; 5/16	12	3	240
BE-9785	0,050; 1/16; 5/64; 3/32; 7/64; 1/8; 9/64; 5/32; 3/16; 7/32; 1/4; 5/16; 3/8	13	3	370



	mm			g
BE-9765	1.5; 2; 2.5; 3; 4; 5	6	3	60
BE-9770	1.5; 2; 2.5; 3; 4; 5; 6; 8; 10	9	3	355



	mm			g
BE-9678	1.5; 2; 2.5; 3; 4; 5; 6; 8; 10	9	1	430



Finitura nera

Torx®



		mm	mm		g
1995TORX-T6	T 6	15	75	5	4
1995TORX-T7	T 7	16	80	5	4
1995TORX-T8	T 8	16	80	5	5
1995TORX-T9	T 9	16	80	5	6
1995TORX-T10	T 10	17	86	5	7
1995TORX-T15	T 15	18	90	5	10
1995TORX-T20	T 20	19	95	5	11
1995TORX-T25	T 25	20	100	5	17
1995TORX-T27	T 27	21	105	5	19
1995TORX-T30	T 30	24	114	5	29
1995TORX-T40	T 40	26	124	5	43
1995TORX-T45	T 45	29	133	5	61
1995TORX-T50	T 50	32	152	5	88



				g
1995TORX/4T	T10; T20; T30; T40	4	1	200
1995TORX/7T	T10; T15; T20; T25; T27; T30; T40	7	1	250
1995TORX/11T	T7; T9; T10; T15; T20; T25; T27; T30; T40; T45; T50	11	1	325
1995TORX/13T	T6; T7; T8; T9; T10; T15; T20; T25; T27; T30; T40; T45; T50	13	1	335



				g
BE-9585	T9; T10; T15; T20; T25; T27; T30; T40	8	1	180



Funzione di smagnetizzazione integrata nel supporto



				g
C1997TORX/9P	T8; T9; T10; T15; T20; T25; T27; T30; T40	9	1	290



				g
BE-9575	T9; T10; T15; T20; T25; T27; T30; T40	8	1	180



Funzione di smagnetizzazione integrata nel supporto





Finitura nera

Torx®



BE-8975B	T9; T10; T15; T20; T25; T27; T30; T40	8	6	290



BE-8975	T9; T10; T15; T20; T25; T27; T30; T40	8	6	295

Finitura nera

Torx® testa sferica



1996TORX-T9	T 9	16	80	3,0	5	4
1996TORX-T10	T 10	17	86	3,0	5	5
1996TORX-T15	T 15	18	90	4,0	5	7
1996TORX-T20	T 20	19	95	4,0	5	10
1996TORX-T25	T 25	20	100	5,0	5	14
1996TORX-T27	T 27	21	105	5,0	5	22
1996TORX-T30	T 30	24	114	6,0	5	30
1996TORX-T40	T 40	26	124	7,0	5	46
1996TORX-T45	T 45	29	133	8,0	5	61
1996TORX-T50	T 50	32	152	9,0	5	82



1996TORX/5T	T10; T20; T25; T30; T40	5	1	200



BE-9675	T9; T10; T15; T20; T25; T27; T30; T40	8	1	175

Finitura nera

Torx® Tamper resistant



1986TORX-T9	TR 9	16	80	3,0	5	4
1986TORX-T10	TR 10	17	86	3,0	5	5
1986TORX-T15	TR 15	18	90	4,0	5	8
1986TORX-T20	TR 20	19	95	4,0	5	11
1986TORX-T25	TR 25	20	100	5,0	5	17
1986TORX-T27	TR 27	21	105	5,0	5	19
1986TORX-T30	TR 30	24	114	6,0	5	29
1986TORX-T40	TR 40	26	124	7,0	5	43



1986TORX/7T	TR-10; TR-15; TR-20; TR-25; TR-27; TR-30; TR-40	7	1	200



BE-8675	TR-9; TR-10; TR-15; TR-20; TR-25; TR-27; TR-30; TR-40	8	1	180



Finitura nera

Torx Plus®



1976TORX-T6	IP 6	75	80	2.5	5	4
1976TORX-T7	IP 7	80	86	2.5	5	4
1976TORX-T8	IP 8	80	90	2.5	5	5
1976TORX-T9	IP 9	80	95	3.0	5	5
1976TORX-T10	IP 10	86	100	3.0	5	5
1976TORX-T15	IP 15	90	105	4.0	5	10
1976TORX-T20	IP 20	95	114	4.0	5	10
1976TORX-T25	IP 25	100	124	5.0	5	17
1976TORX-T27	IP 27	105	100	5.0	5	19
1976TORX-T30	IP 30	114	105	6.0	5	29
1976TORX-T40	IP 40	124	114	7.0	5	43



1976TORX/5T	IP10; IP20; IP25; IP30; IP40	5	1	110		



BE-7675	IP9; IP10; IP15; IP20; IP25; IP27; IP30; IP40	8	1	220		

Cacciavite esagonali a squadra

Intaglio semplice



2047-0.8-4	0.8	4	100	5	14
2047-1-5.5	1.0	5.5	125	5	21
2047-1.2-8	1.2	8	150	5	37
2047-1.6-10	1.6	10	175	1	60
2047-2-12	2.0	12	200	1	115

Phillips



2047PR-1-2	PH 1 & 2	100	5	25
2047PR-3-4	PH 3 & 4	200	5	110







Altri cacciavite

Cacciavite con impugnatura in legno

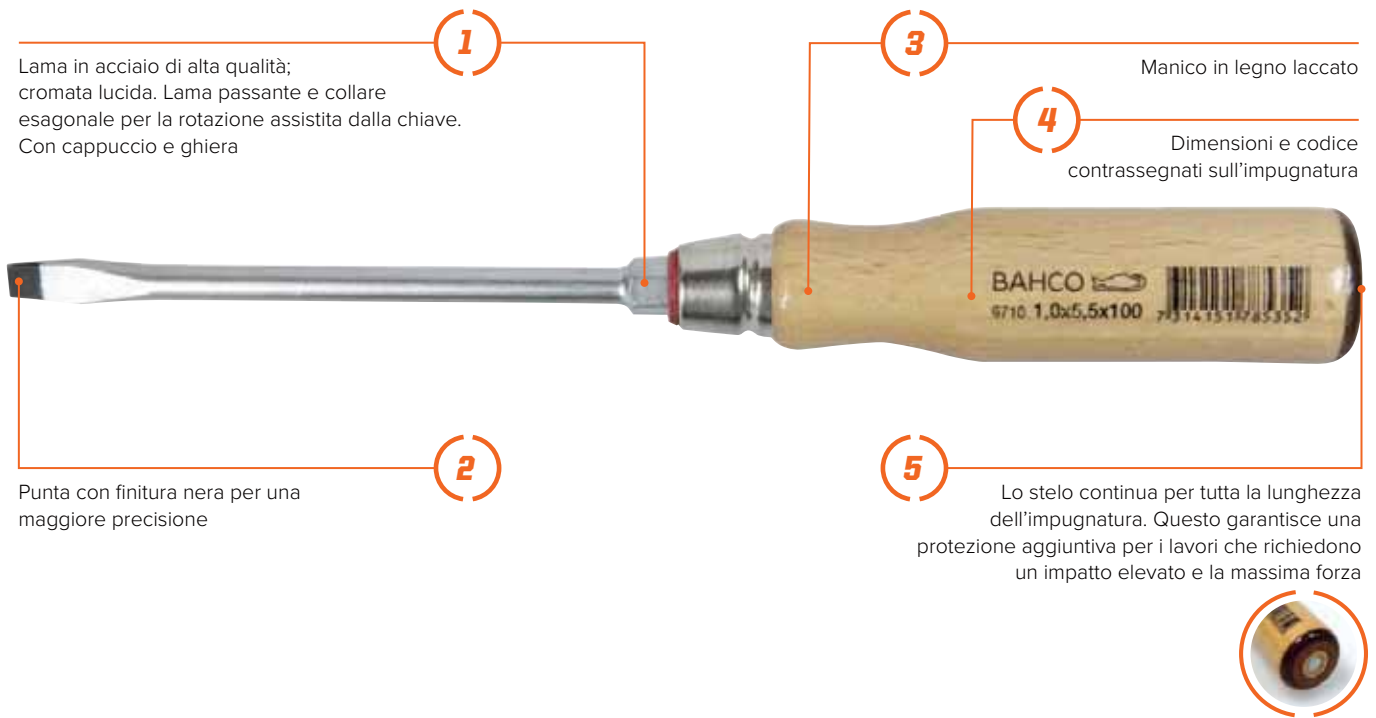

1
Lama in acciaio di alta qualità; cromata lucida. Lama passante e collare esagonale per la rotazione assistita dalla chiave. Con cappuccio e ghiera

3
Manico in legno laccato

4
Dimensioni e codice contrassegnati sull'impugnatura

2
Punta con finitura nera per una maggiore precisione

5
Lo stelo continua per tutta la lunghezza dell'impugnatura. Questo garantisce una protezione aggiuntiva per i lavori che richiedono un impatto elevato e la massima forza



Intaglio semplice

Piatto



9710-3.5-75	0.6	3.5	75	22x95	10	47
9710-5.5-100	1.0	5.5	100	24x100	10	67
9710-6.5-125	1.2	6.5	125	27x110	10	114
9710-8-150	1.2	8.0	150	30x120	5	174
9710-10-175	1.6	10.0	175	32x125	5	223

Phillips



9778-1	PH 1	80	24x100	10	45	
9778-2	PH 2	110	27x110	10	90	
9778-3	PH 3	150	30x120	5	160	

Pozidriv



9778PZD-1	PZ 1	80	24x100	10	45	
9778PZD-2	PZ 2	110	27x110	10	90	

Assortimento cacciavite



Assortimento 6 pezzi



9710/S6					1	650
9710						
0.8x4.5x90; 1x5.5x100; 1.2x6.5x125; 1.2x8x150						
9778						
PH1x80; PH2x110						

Cacciavite reversibili

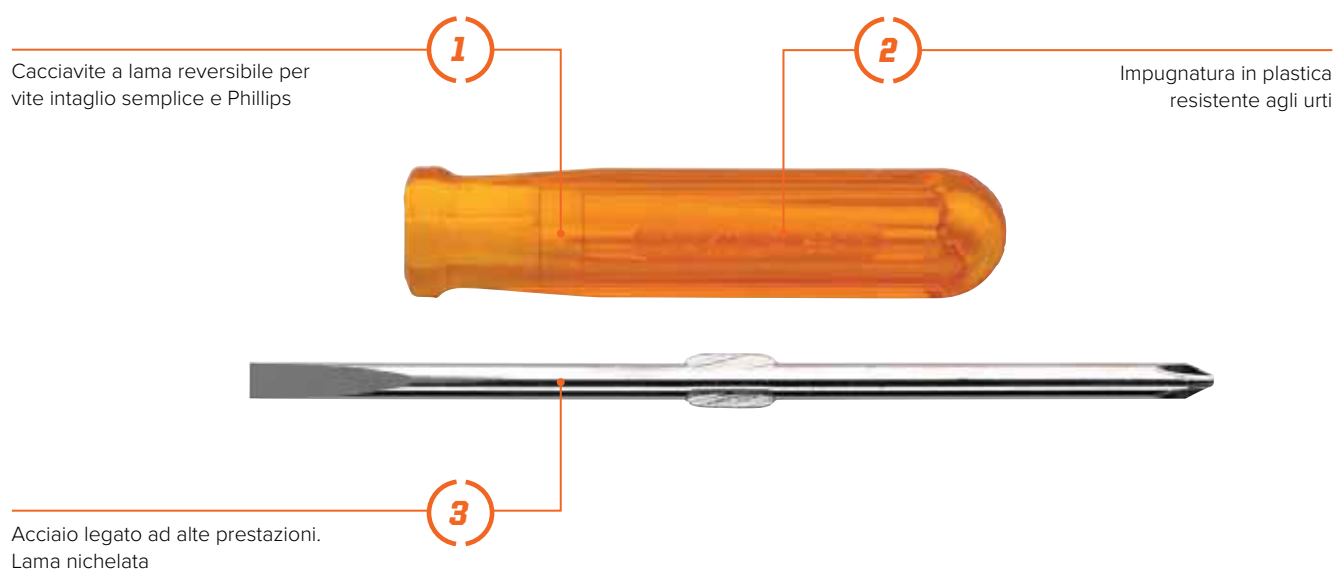

1019	1.2	6	PH 2	10	26
1067	0.8	4.5	PH 1	10	30

1016	1	6	PH 2	10	50

6	3.5-5.0-6.5	PH 0, PH 1, PH 2	1	250	

8052	1.0	6.0	PH 2	80	28x110
				5	90

- Assortimento di cacciavite a lama reversibile, 6 pezzi: PH 0, PH 1, PH 2 e intaglio semplice 3,5-5,0-6,5 mm
- In busta di plastica con foro per appendere



Tester di tensione

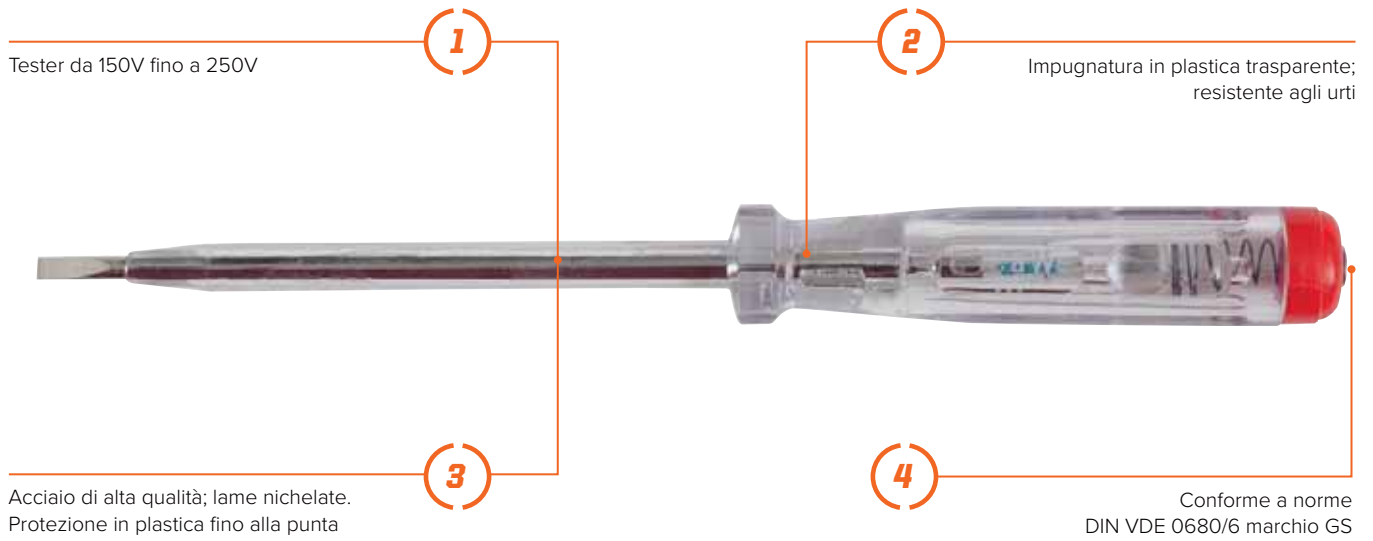

Modello	Spessore lama (mm)	Lunghezza lama (mm)	Lunghezza manico (mm)	Lunghezza totale (mm)	Spessore manico (mm)	Peso (g)
806-1-1	0.5	3	65	17x75	6	30
806-1-2	0.6	3.5	100	17x90	6	29

Modello	Spessore lama (mm)	Lunghezza lama (mm)	Lunghezza manico (mm)	Lunghezza totale (mm)	Spessore manico (mm)	Peso (g)
8045VDE	0.5	3.5	77	14x92	10	40

Modello	Spessore lama (mm)	Lunghezza lama (mm)	Lunghezza manico (mm)	Lunghezza totale (mm)	Spessore manico (mm)	Peso (g)
806-1-3	0.5	3	45	13x75	6	22

Modello	Spessore lama (mm)	Lunghezza lama (mm)	Lunghezza manico (mm)	Lunghezza totale (mm)	Spessore manico (mm)	Peso (g)
8045LVDE	0.5	3.5	42	16x90	6	28

Magnetizzatori

Per magnetizzare e smagnetizzare le lame dei cacciavite, le pinzette e altri strumenti in acciaio



M780

Struttura in plastica estremamente resistente



Foro per appendere



Per magnetizzare e smagnetizzare le lame di cacciavite, pinzette e altri utensili in acciaio



Realizzato in plastica di alta qualità



Comoda impugnatura per un facile utilizzo



M781

M780	1	95

M781	5	35

Multiutensile per bicicletta

Set di bussole miste speciali per bicicletta



Supporto in metallo



Custodia in tela con attacco per cintura.

Confezione self-service con scheda informativa



17 utensili diversi:

- bussole 1/4", 8, 9, 10 mm
- cacciavite per bussole 1/4"
- cacciavite 0.8x5.0, PH2, HEX 2, 2.5, 3, 4, 5, 6, 8 mm
- chiavi fisse: 8, 10, 15 mm
- tiraraggi

BKE850901N	10	340



Cacciavite a percussione

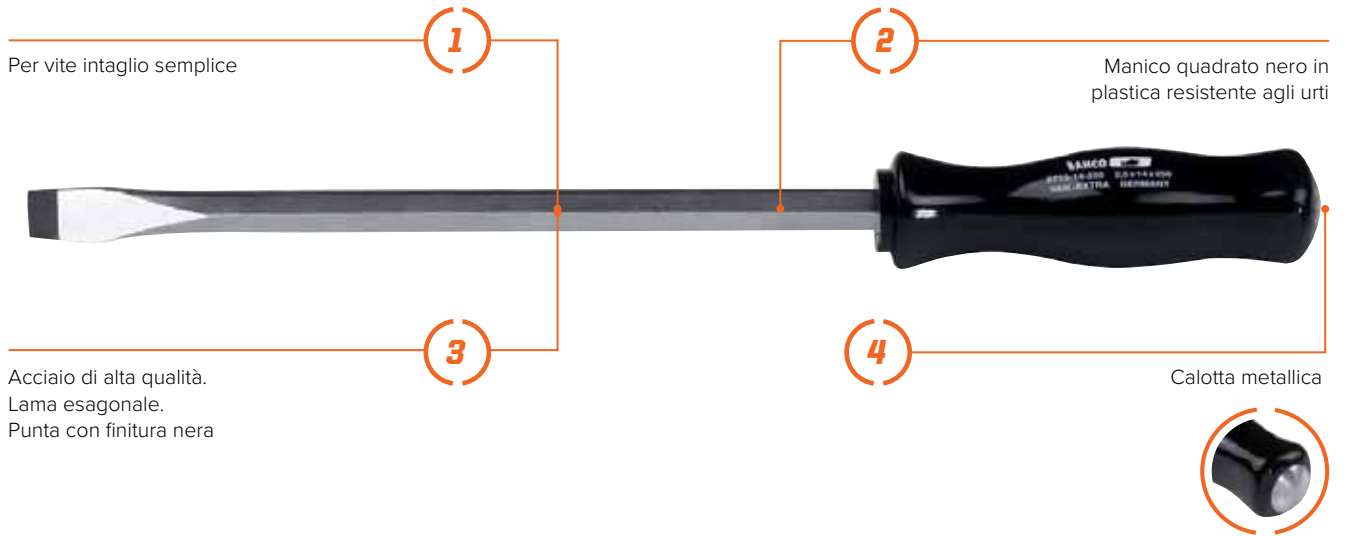

9715-14-250	2.5	14.0	250	37x140	5	460	



La calotta metallica offre una protezione aggiuntiva per i lavori che richiedono un impatto elevato e la massima forza. Lo stelo continua ad attraversare l'impugnatura prima di entrare in contatto con la calotta metallica per una maggiore resistenza.



SDCAT24-ITA

BAHCO®

www.bahco.com